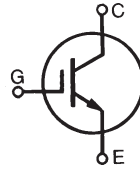


**GenX3™ 300V IGBT**
**IXGH120N30C3\***

\*Obsolete Part Number

**High speed PT IGBTs for  
50-150kHz switching**


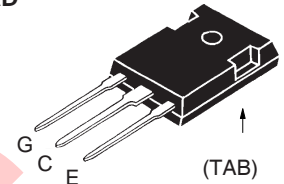
$$V_{CES} = 300V$$

$$I_{C110} = 120A$$

$$V_{CE(sat)} \leq 2.1V$$

$$t_{fi(typ)} = 86ns$$

Symbol	Test Conditions	Maximum Ratings	
$V_{CES}$	$T_J = 25^\circ C$ to $150^\circ C$	300	V
$V_{CGR}$	$T_J = 25^\circ C$ to $150^\circ C$ , $R_{GE} = 1M\Omega$	300	V
$V_{GES}$	Continuous	$\pm 20$	V
$V_{GEM}$	Transient	$\pm 30$	V
$I_{C25}$	$T_C = 25^\circ C$ (limited by leads)	75	A
$I_{C110}$	$T_C = 110^\circ C$ (chip capability)	120	A
$I_{CM}$	$T_C = 25^\circ C$ , 1ms	600	A
$I_A$	$T_C = 25^\circ C$	120	A
$E_{AS}$	$T_C = 25^\circ C$	850	mJ
<b>SSOA</b> <b>(RBSOA)</b>	$V_{GE} = 15V$ , $T_{VJ} = 125^\circ C$ , $R_G = 2\Omega$ Clamped inductive load @ $\leq 300V$	$I_{CM} = 240$	A
$P_C$	$T_C = 25^\circ C$	540	W
$T_J$		-55 ... +150	$^\circ C$
$T_{JM}$		150	$^\circ C$
$T_{stg}$		-55 ... +150	$^\circ C$
$T_L$ $T_{SOLD}$	Maximum lead temperature for soldering 1.6mm (0.062 in.) from case for 10s	300 260	$^\circ C$ $^\circ C$
$M_d$	Mounting torque	1.13/10	Nm/lb.in.
<b>Weight</b>		6	g

**TO-247 AD  
(IXGH)**

 G = Gate,  
E = Emitter,  
C = Collector,  
TAB = Collector

**Features**

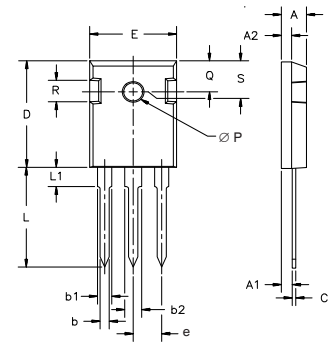
- High Frequency IGBT
- Square RBSOA
- High avalanche capability
- Drive simplicity with MOS Gate Turn-On
- High current handling capability

**Applications**

- PFC Circuits
- PDP Systems
- Switched-mode and resonant-mode converters and inverters
- SMPS
- AC motor speed control
- DC servo and robot drives
- DC choppers

Symbol	Test Conditions	Characteristic Values ( $T_J = 25^\circ C$ , unless otherwise specified)		
		Min.	Typ.	Max.
$BV_{CES}$	$I_C = 250\mu A$ , $V_{GE} = 0V$	300		V
$V_{GE(th)}$	$I_C = 250\mu A$ , $V_{CE} = V_{GE}$	2.5		V
$I_{CES}$	$V_{CE} = V_{CES}$ $V_{GE} = 0V$ $T_J = 125^\circ C$			50 $\mu A$ 1.0 mA
$I_{GES}$	$V_{CE} = 0V$ , $V_{GE} = \pm 20V$			$\pm 100$ nA
$V_{CE(sat)}$	$I_C = 120A$ , $V_{GE} = 15V$ $T_J = 125^\circ C$	1.75 1.70	2.10	V V

Symbol	Test Conditions ( $T_J = 25^\circ\text{C}$ , unless otherwise specified)	Characteristic Values		
		Min.	Typ.	Max.
$g_{fs}$	$I_C = 60\text{A}$ , $V_{CE} = 10\text{V}$ , Pulse test, $t \leq 300\mu\text{s}$ ; duty cycle, $d \leq 2\%$ .	50	83	S
$C_{ies}$	$V_{CE} = 25\text{V}$ , $V_{GE} = 0\text{V}$ , $f = 1\text{MHz}$		8700	pF
$C_{oes}$			715	pF
$C_{res}$			195	pF
$Q_g$	$I_C = I_{C110}$ , $V_{GE} = 15\text{V}$ , $V_{CE} = 0.5 \cdot V_{CES}$		230	nC
$Q_{ge}$			32	nC
$Q_{gc}$			87	nC
$t_{d(on)}$	<b>Inductive Load, <math>T_J = 25^\circ\text{C}</math></b> $I_C = 60\text{A}$ , $V_{GE} = 15\text{V}$ $V_{CE} = 200\text{V}$ , $R_G = 2\Omega$		28	ns
$t_{ri}$			37	ns
$E_{on}$			0.23	mJ
$t_{d(off)}$			109	160 ns
$t_{fi}$			86	ns
$E_{off}$			0.73	1.3 mJ
$t_{d(on)}$	<b>Inductive Load, <math>T_J = 125^\circ\text{C}</math></b> $I_C = 60\text{A}$ , $V_{GE} = 15\text{V}$ $V_{CE} = 200\text{V}$ , $R_G = 2\Omega$		28	ns
$t_{ri}$			38	ns
$E_{on}$			0.37	mJ
$t_{d(off)}$			120	ns
$t_{fi}$			113	ns
$E_{off}$			0.88	mJ
$R_{thJC}$			0.23 $^\circ\text{C/W}$	
$R_{thCK}$		0.21	$^\circ\text{C/W}$	

**TO-247 AD Outline**


Dim.	Millimeter		Inches	
	Min.	Max.	Min.	Max.
A	4.7	5.3	.185	.209
A <sub>1</sub>	2.2	2.54	.087	.102
A <sub>2</sub>	2.2	2.6	.059	.098
b	1.0	1.4	.040	.055
b <sub>1</sub>	1.65	2.13	.065	.084
b <sub>2</sub>	2.87	3.12	.113	.123
C	.4	.8	.016	.031
D	20.80	21.46	.819	.845
E	15.75	16.26	.610	.640
e	5.20	5.72	0.205	0.225
L	19.81	20.32	.780	.800
L1		4.50		.177
∅P	3.55	3.65	.140	.144
Q	5.89	6.40	0.232	0.252
R	4.32	5.49	.170	.216
S	6.15	BSC	242	BSC

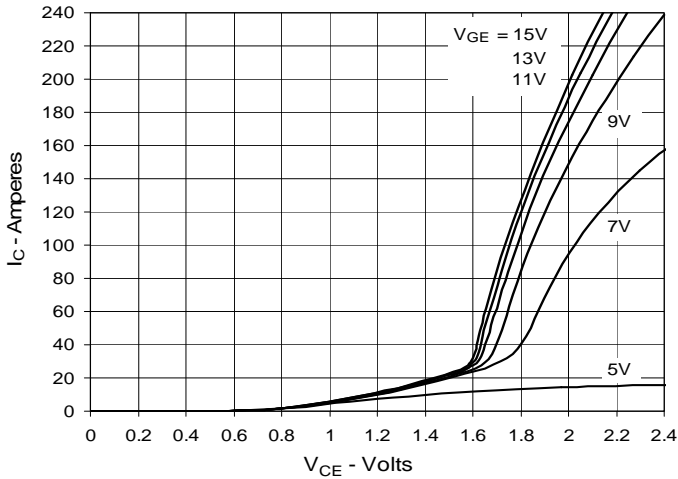
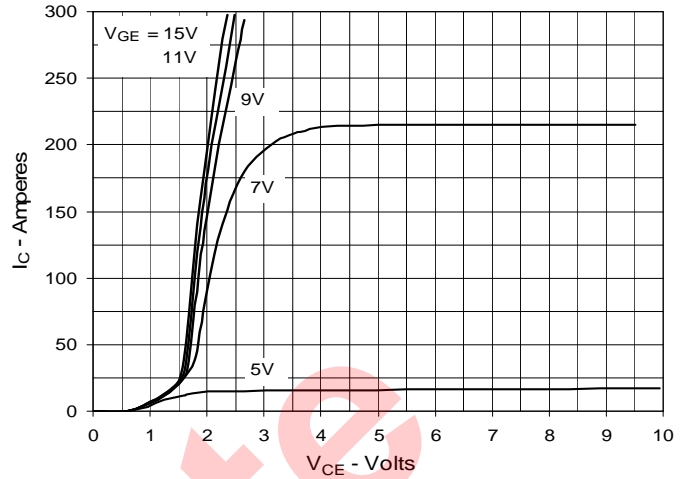
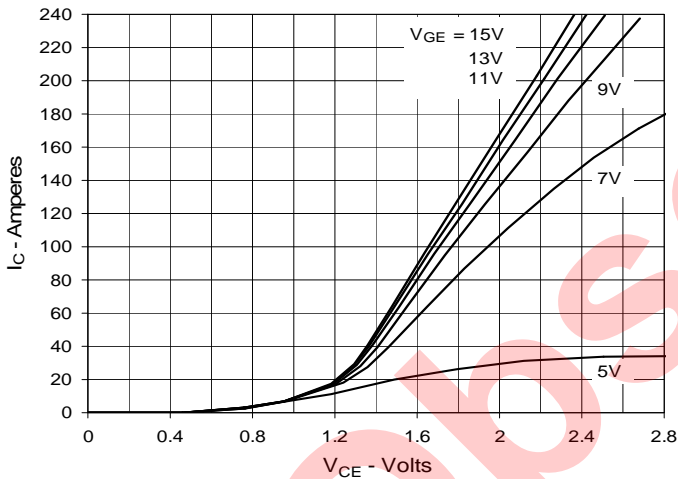
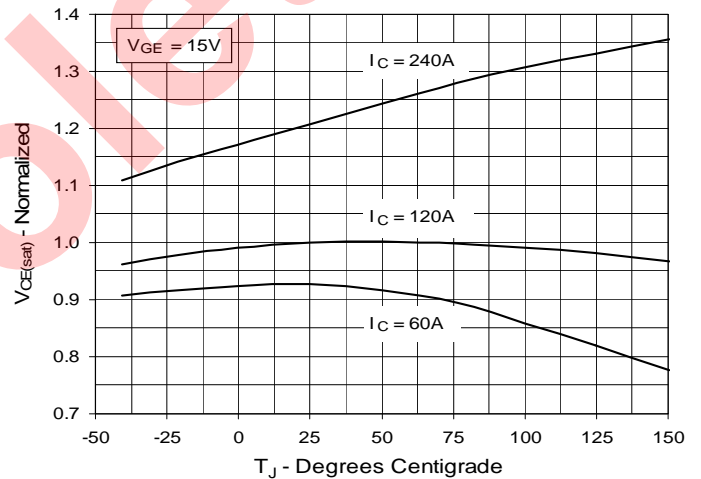
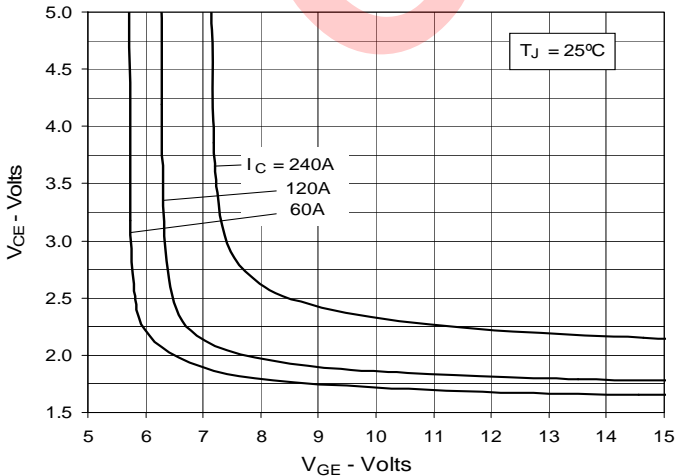
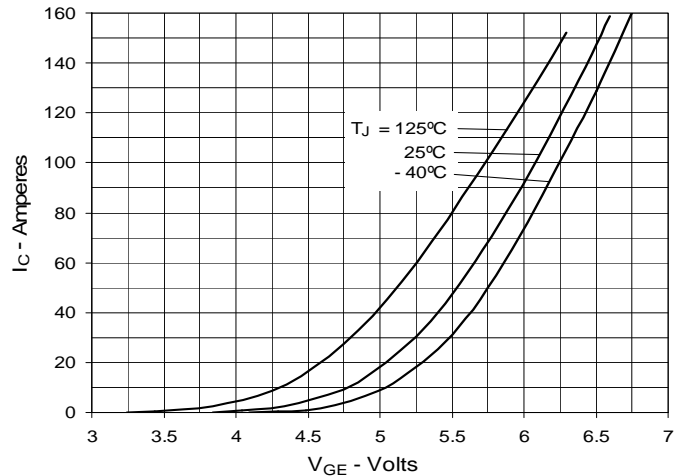
**PRELIMINARY TECHNICAL INFORMATION**

The product presented herein is under development. The Technical Specifications offered are derived from data gathered during objective characterizations of preliminary engineering lots; but also may yet contain some information supplied during a pre-production design evaluation. IXYS reserves the right to change limits, test conditions, and dimensions without notice.

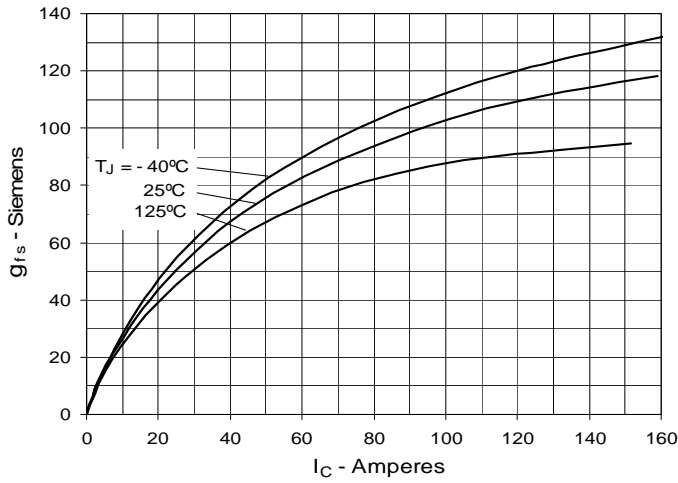
IXYS reserves the right to change limits, test conditions, and dimensions.

IXYS MOSFETs and IGBTs are covered by one or more of the following U.S. patents:

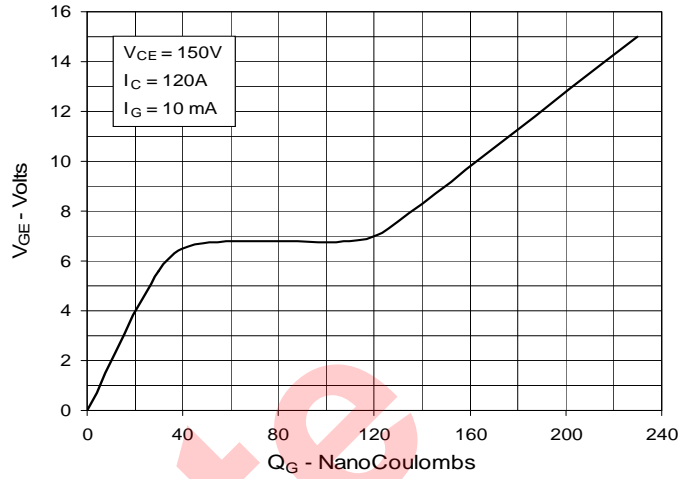
4,835,592	4,931,844	5,049,961	5,237,481	6,162,665	6,404,065 B1	6,683,344	6,727,585	7,005,734 B2	7,157,338B2
4,850,072	5,017,508	5,063,307	5,381,025	6,259,123 B1	6,534,343	6,710,405 B2	6,759,692	7,063,975 B2	
4,881,106	5,034,796	5,187,117	5,486,715	6,306,728 B1	6,583,505	6,710,463	6,771,478 B2	7,071,537	

**Fig. 1. Output Characteristics @ 25°C**

**Fig. 2. Extended Output Characteristics @ 25°C**

**Fig. 3. Output Characteristics @ 125°C**

**Fig. 4. Dependence of  $V_{CE(sat)}$  on Junction Temperature**

**Fig. 5. Collector-to-Emitter Voltage vs. Gate-to-Emitter Voltage**

**Fig. 6. Input Admittance**


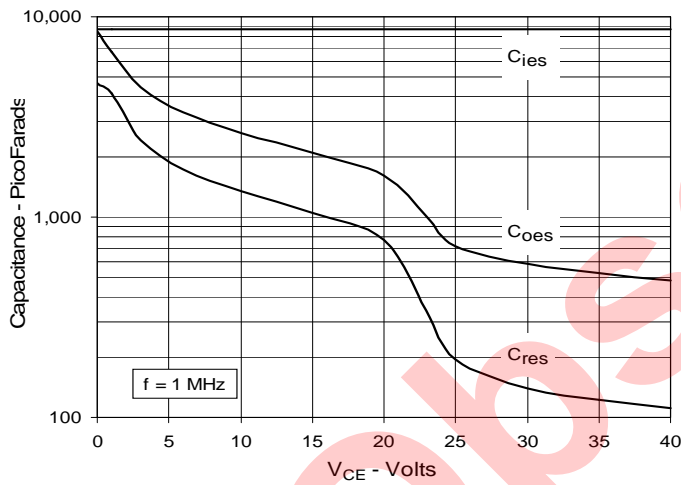
**Fig. 7. Transconductance**



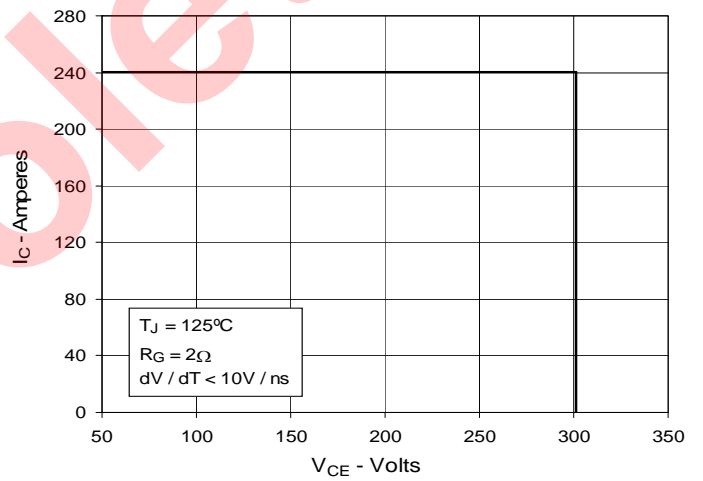
**Fig. 8. Gate Charge**



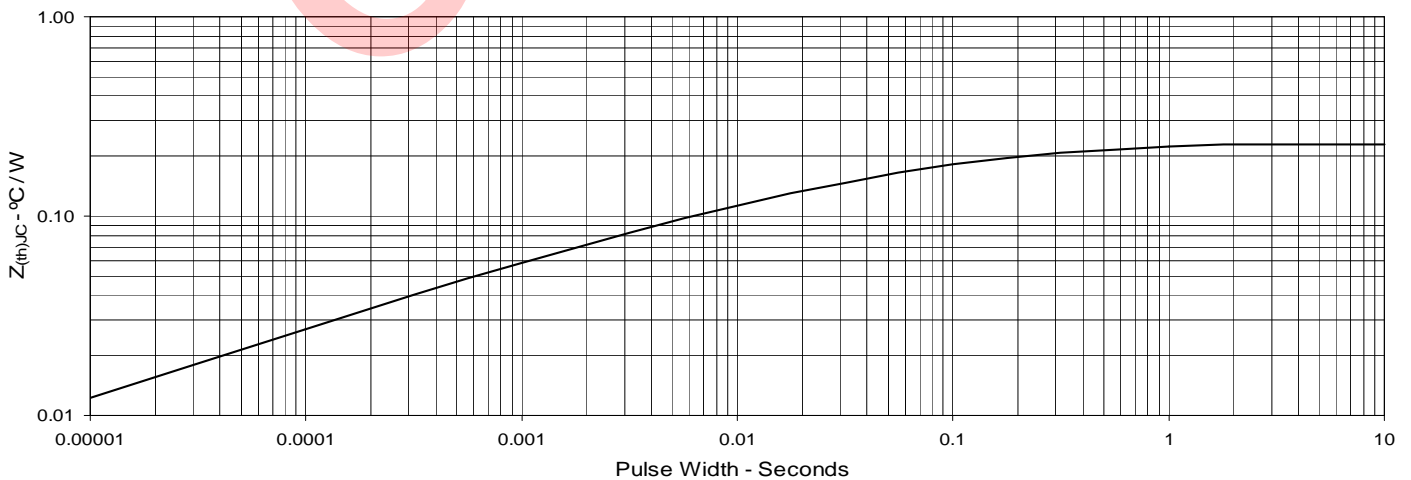
**Fig. 9. Capacitance**

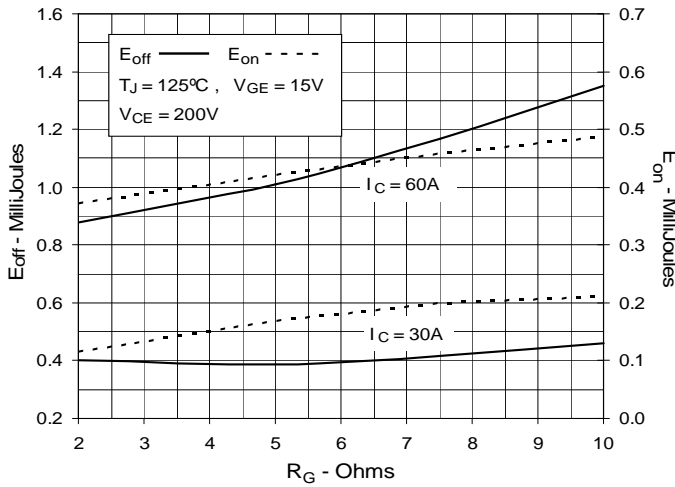
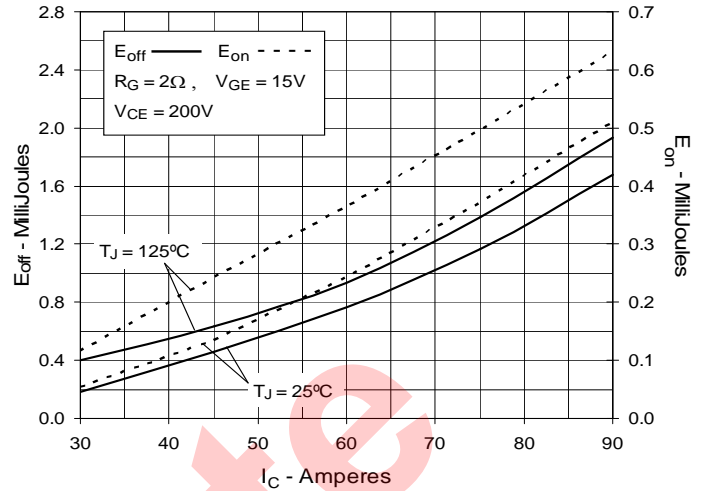
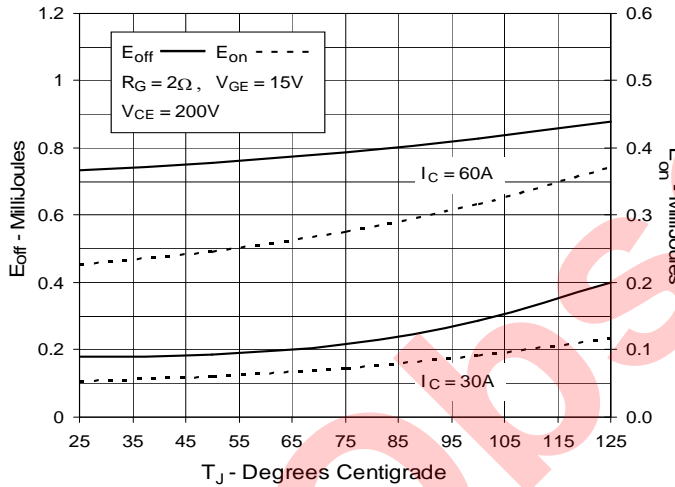
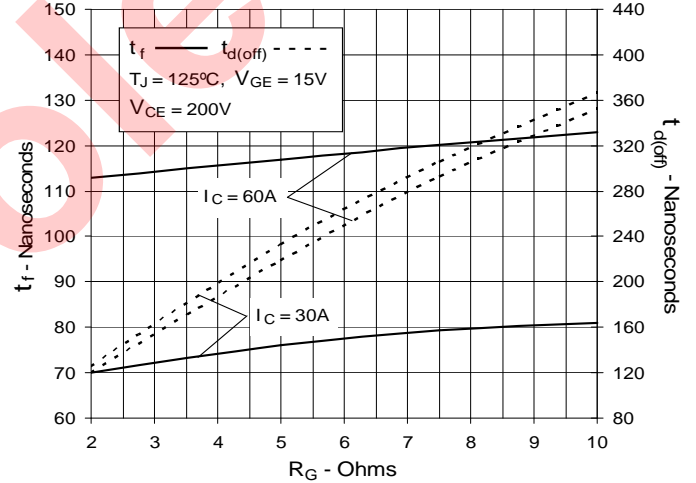
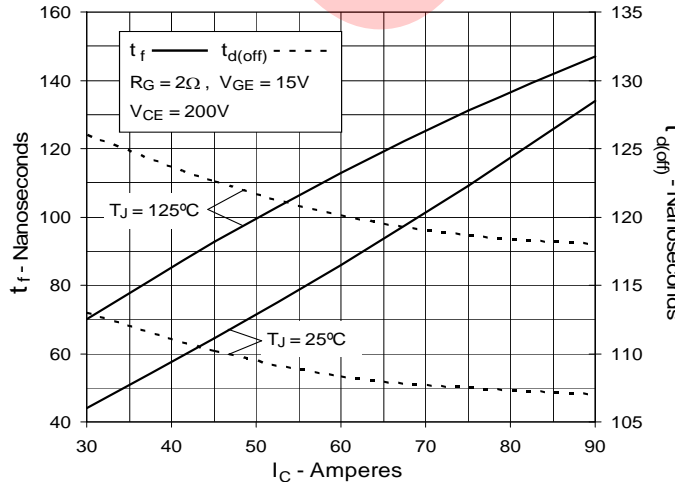
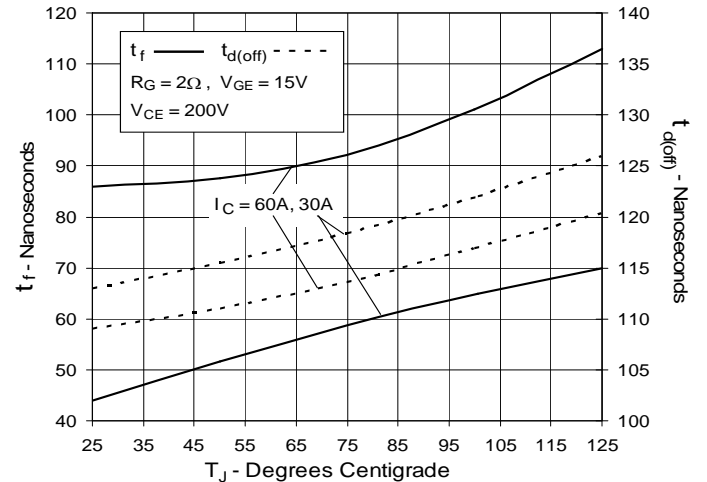


**Fig. 10. Reverse-Bias Safe Operating Area**

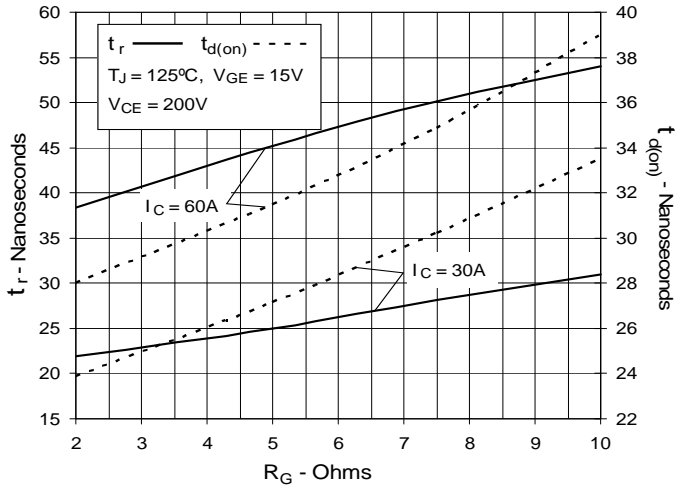


**Fig. 11. Maximum Transient Thermal Impedance**

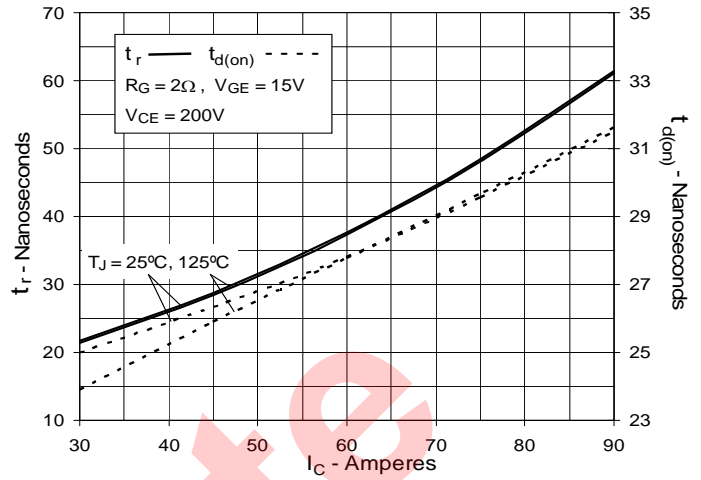


**Fig. 12. Inductive Switching Energy Loss vs. Gate Resistance**

**Fig. 13. Inductive Switching Energy Loss vs. Collector Current**

**Fig. 14. Inductive Switching Energy Loss vs. Junction Temperature**

**Fig. 15. Inductive Turn-off Switching Times vs. Gate Resistance**

**Fig. 16. Inductive Turn-off Switching Times vs. Collector Current**

**Fig. 17. Inductive Turn-off Switching Times vs. Junction Temperature**


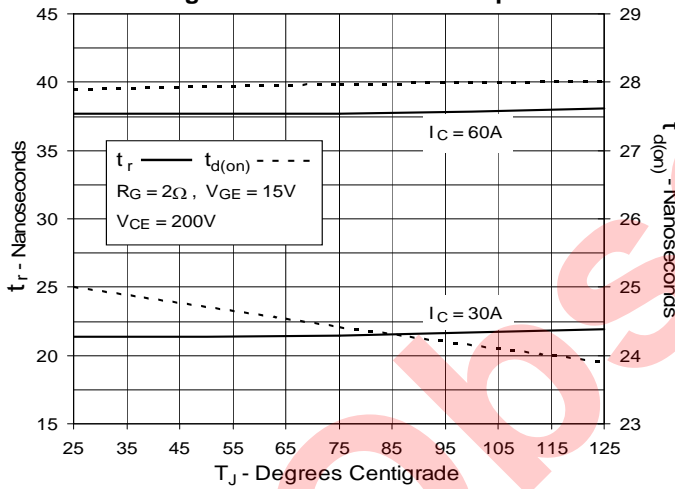
**Fig. 18. Inductive Turn-on Switching Times vs. Gate Resistance**



**Fig. 19. Inductive Turn-on Switching Times vs. Collector Current**



**Fig. 20. Inductive Turn-on Switching Times vs. Junction Temperature**



Obsolete



**IXYS**  
A Littelfuse Technology

---

Disclaimer Notice - Information furnished is believed to be accurate and reliable. However, users should independently evaluate the suitability of and test each product selected for their own applications. Littelfuse products are not designed for, and may not be used in, all applications. Read complete Disclaimer Notice at [www.littelfuse.com/disclaimer-electronics](http://www.littelfuse.com/disclaimer-electronics).