

# GenX3™ 600V IGBT

## IXGK320N60A3 IXGX320N60A3

$V_{CES} = 600V$   
 $I_{C110} = 210A$   
 $V_{CE(sat)} \leq 1.30V$

Ultra-Low  $V_{sat}$  PT IGBTs for  
up to 5kHz Switching

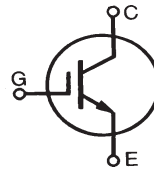

Symbol	Test Conditions	Maximum Ratings	
$V_{CES}$	$T_J = 25^\circ C$ to $150^\circ C$	600	V
$V_{CGR}$	$T_J = 25^\circ C$ to $150^\circ C$ , $R_{GE} = 1M\Omega$	600	V
$V_{GES}$	Continuous	$\pm 20$	V
$V_{GEM}$	Transient	$\pm 30$	V
$I_{C25}$	$T_C = 25^\circ C$ (Chip Capability)	320	A
$I_{C110}$	$T_C = 110^\circ C$	210	A
$I_{LRMS}$	Terminal Current Limit	160	A
$I_{CM}$	$T_C = 25^\circ C$ , 1ms	700	A
<b>SSOA</b> <b>(RBSOA)</b>	$V_{GE} = 15V$ , $T_{VJ} = 125^\circ C$ , $R_G = 1\Omega$ Clamped Inductive Load	$I_{CM} = 320$ @ $0.8 \cdot V_{CES}$	A
$P_C$	$T_C = 25^\circ C$	1000	W
$T_J$		-55 ... +150	$^\circ C$
$T_{JM}$		150	$^\circ C$
$T_{stg}$		-55 ... +150	$^\circ C$
$T_L$	Maximum Lead Temperature for Soldering	300	$^\circ C$
$T_{SOLD}$	1.6 mm (0.062 in.) from Case for 10	260	$^\circ C$
$M_d$	Mounting Torque (IXGK)	1.13/10	Nm/lb.in
$F_C$	Mounting Force (IXGX)	20..120/4.5..27	N/lb
<b>Weight</b>	TO-264	10	g
	PLUS247	6	g

### TO-264 (IXGK)

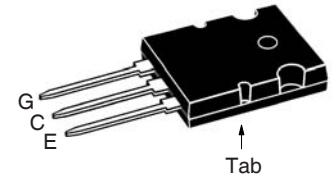

### PLUS247 (IXGX)

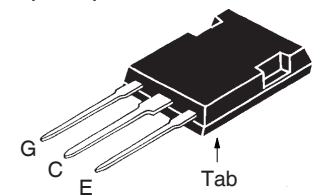

G = Gate                      E = Emitter  
C = Collector                Tab = Collector

### Features

- Optimized for Low Conduction Losses
- High Avalanche Capability
- International Standard Packages

### Advantages

- High Power Density
- Low Gate Drive Requirement

### Applications

- Power Inverters
- UPS
- Motor Drives
- SMPS
- PFC Circuits
- Battery Chargers
- Welding Machines
- Lamp Ballasts
- Inrush Current Protection Circuits

Symbol	Test Conditions ( $T_J = 25^\circ C$ , Unless Otherwise Specified)	Characteristic Values		
		Min.	Typ.	Max.
$BV_{CES}$	$I_C = 1mA$ , $V_{GE} = 0V$	600		V
$V_{GE(th)}$	$I_C = 4mA$ , $V_{CE} = V_{GE}$	3.0		5.5 V
$I_{CES}$	$V_{CE} = V_{CES}$ , $V_{GE} = 0V$ $T_J = 125^\circ C$			150 $\mu A$ 1.5 mA
$I_{GES}$	$V_{CE} = 0V$ , $V_{GE} = \pm 20V$			$\pm 400$ nA
$V_{CE(sat)}$	$I_C = 100A$ , $V_{GE} = 15V$ , Note 1	1.05	1.30	V
	$I_C = 320A$	1.46		V

Symbol	Test Conditions ( $T_J = 25^\circ\text{C}$ , Unless Otherwise Specified)	Characteristic Values		
		Min.	Typ.	Max.
$g_{fs}$	$I_C = 60\text{A}, V_{CE} = 10\text{V}$ , Note 1	75	125	S
$C_{ies}$	$V_{CE} = 25\text{V}, V_{GE} = 0\text{V}, f = 1\text{MHz}$		18	nF
$C_{oes}$			985	pF
$C_{res}$			150	pF
$Q_{g(on)}$	$I_C = 80\text{A}, V_{GE} = 15\text{V}, V_{CE} = 0.5 \cdot V_{CES}$		560	nC
$Q_{ge}$			94	nC
$Q_{gc}$			195	nC
$t_{d(on)}$	<b>Resistive load, <math>T_J = 25^\circ\text{C}</math></b>		63	ns
$t_r$			68	ns
$t_{d(off)}$	$I_C = 80\text{A}, V_{GE} = 15\text{V}$		290	ns
$t_f$			740	ns
$t_{d(on)}$	<b>Resistive load, <math>T_J = 125^\circ\text{C}</math></b>		62	ns
$t_r$			77	ns
$t_{d(off)}$	$I_C = 80\text{A}, V_{GE} = 15\text{V}$		330	ns
$t_f$			1540	ns
$R_{thJC}$	$V_{CE} = 400\text{V}, R_G = 1\Omega$			0.125 $^\circ\text{C/W}$
$R_{thCK}$			0.15	$^\circ\text{C/W}$

Note 1. Pulse test,  $t \leq 300\mu\text{s}$ , duty cycle,  $d \leq 2\%$ .

### TO-264 Outline

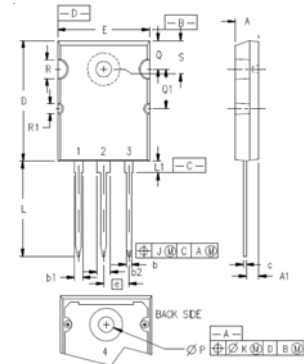

Terminals: 1 - Gate 2, 4 - Collector  
3 - Emitter

SYM	INCHES		MILLIMETERS	
	MIN	MAX	MIN	MAX
A	.185	.209	4.70	5.31
A1	.102	.118	2.59	3.00
b	.037	.055	0.94	1.40
b1	.087	.102	2.21	2.59
b2	.110	.126	2.79	3.20
c	.017	.029	0.43	0.74
D	1.007	1.047	25.58	26.59
E	.760	.799	19.30	20.29
e	.215 BSC		5.46 BSC	
J	.000	.010	0.00	0.25
K	.000	.010	0.00	0.25
L	.779	.842	19.79	21.39
L1	.087	.102	2.21	2.59
ØP	.122	.138	3.10	3.51
Q	.240	.256	6.10	6.50
Q1	.330	.346	8.38	8.79
ØR	.155	.187	3.94	4.75
ØR1	.085	.093	2.16	2.36
S	.243	.253	6.17	6.43

### PLUS247™ Outline

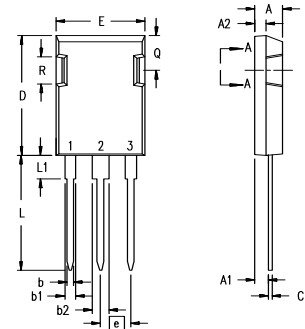

Terminals: 1 - Gate  
2 - Collector  
3 - Emitter

Dim.	Millimeter		Inches	
	Min.	Max.	Min.	Max.
A	4.83	5.21	.190	.205
A <sub>1</sub>	2.29	2.54	.090	.100
A <sub>2</sub>	1.91	2.16	.075	.085
b	1.14	1.40	.045	.055
b <sub>1</sub>	1.91	2.13	.075	.084
b <sub>2</sub>	2.92	3.12	.115	.123
C	0.61	0.80	.024	.031
D	20.80	21.34	.819	.840
E	15.75	16.13	.620	.635
e	5.45 BSC		.215 BSC	
L	19.81	20.32	.780	.800
L1	3.81	4.32	.150	.170
Q	5.59	6.20	.220	0.244

IXYS Reserves the Right to Change Limits, Test Conditions, and Dimensions.

IXYS MOSFETs and IGBTs are covered 4,835,592 4,931,844 5,049,961 5,237,481 6,162,665 6,404,065 B1 6,683,344 6,727,585 7,005,734 B2 7,157,338 B2  
by one or more of the following U.S. patents: 4,860,072 5,017,508 5,063,307 5,381,025 6,259,123 B1 6,534,343 6,710,405 B2 6,759,692 7,063,975 B2  
4,881,106 5,034,796 5,187,117 5,486,715 6,306,728 B1 6,583,505 6,710,463 6,771,478 B2 7,071,537

**Fig. 1. Extended Output Characteristics @  $T_J = 25^\circ\text{C}$**

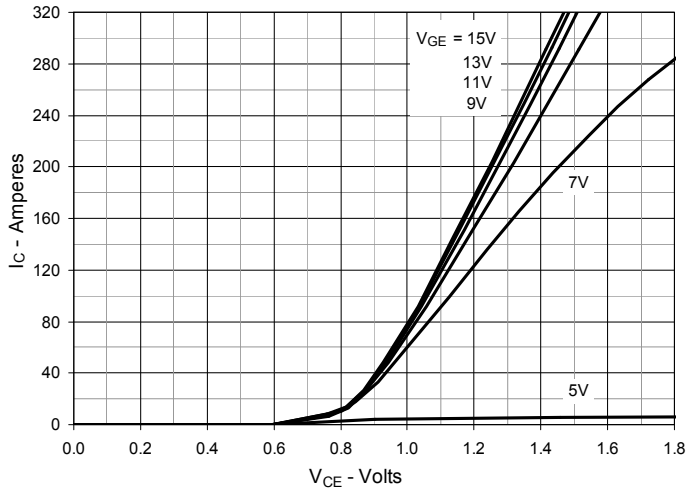

**Fig. 2. Output Characteristics @  $T_J = 125^\circ\text{C}$**

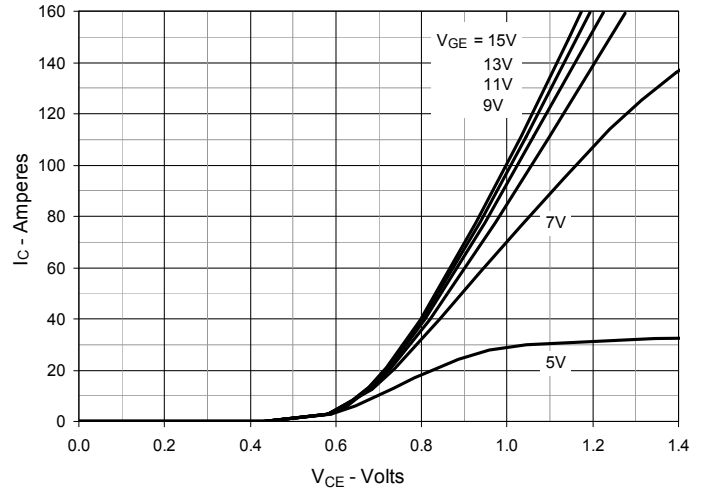

**Fig. 3. Dependence of  $V_{CE(sat)}$  on Junction Temperature**

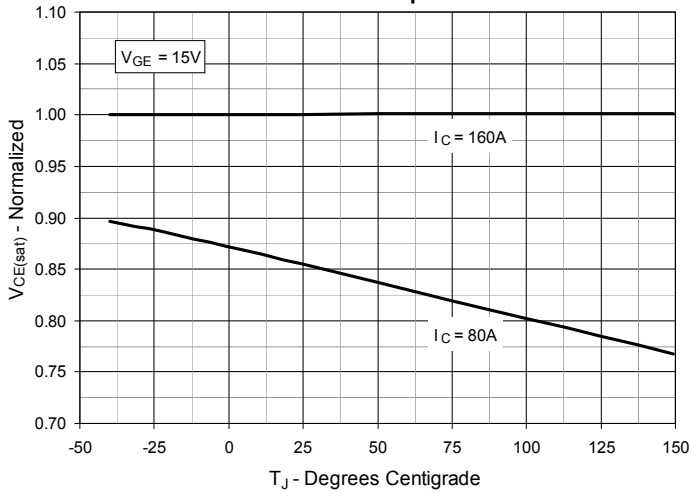

**Fig. 4. Collector-to-Emitter Voltage vs. Gate-to-Emitter Voltage**

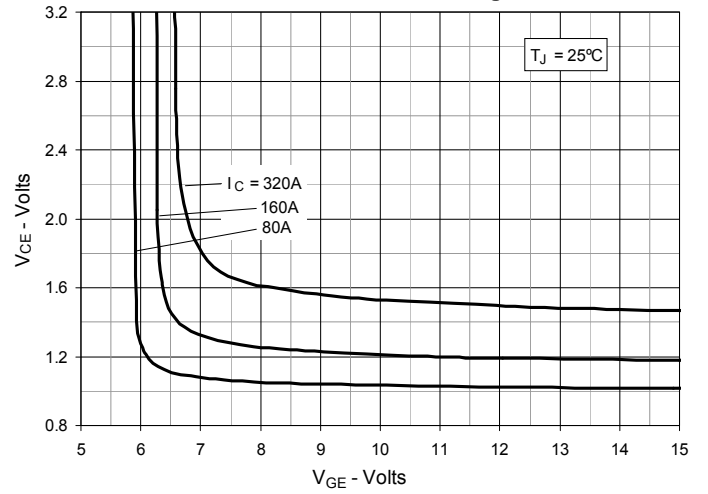

**Fig. 5. Input Admittance**

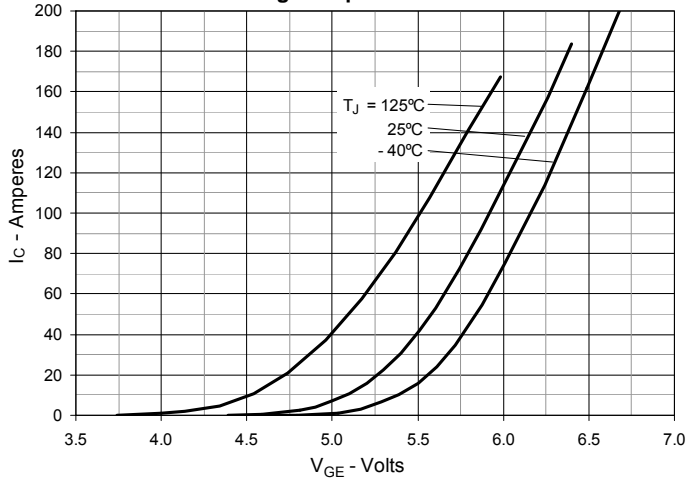

**Fig. 6. Transconductance**

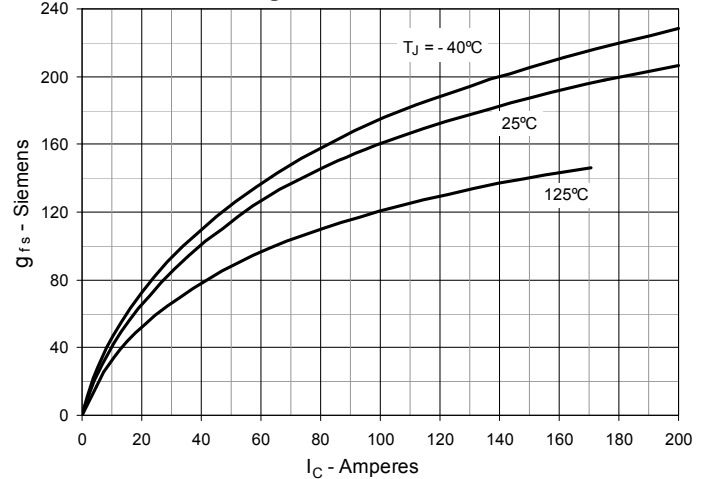

Fig. 7. Gate Charge

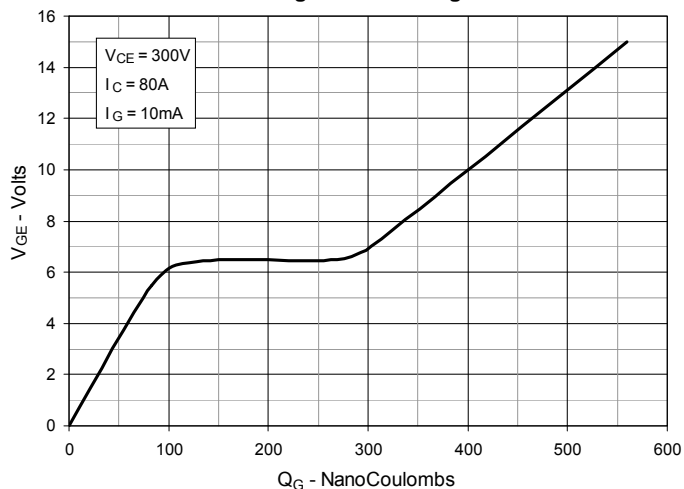

Fig. 8. Capacitance

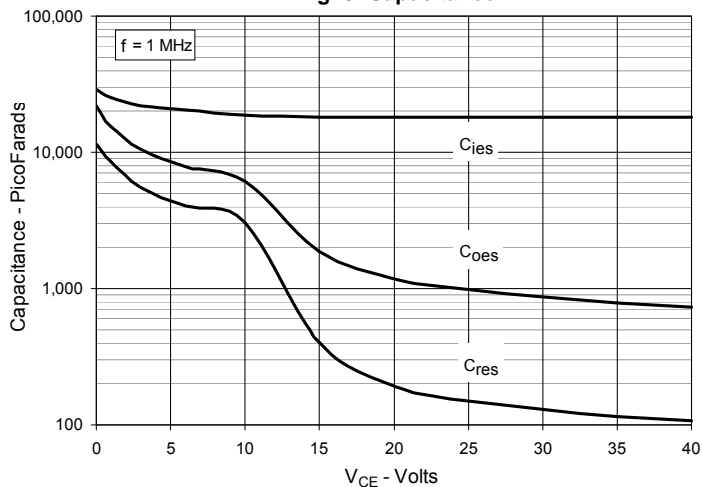

Fig. 9. Reverse-Bias Safe Operating Area

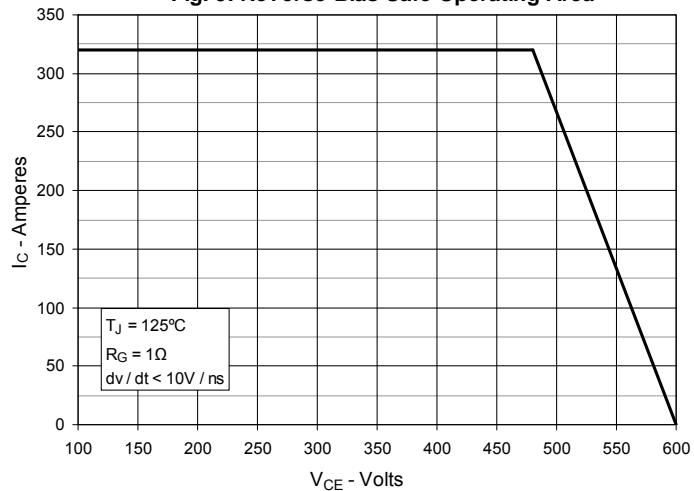
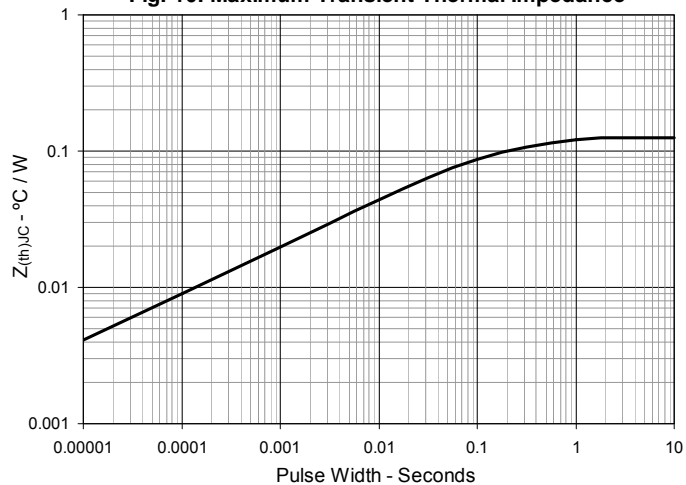
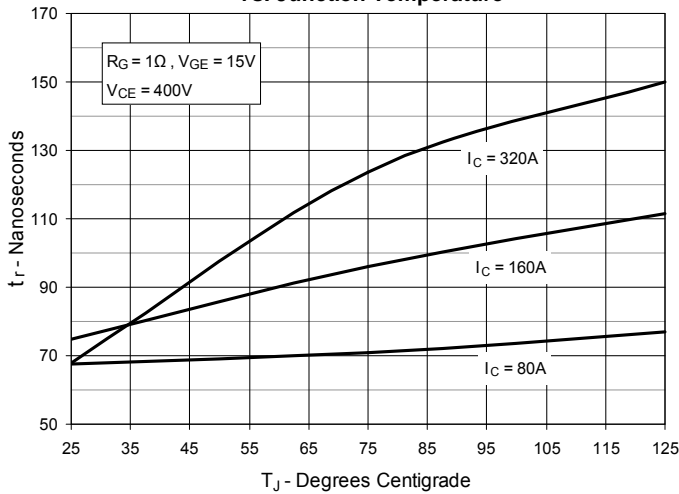

Fig. 10. Maximum Transient Thermal Impedance



**Fig.11. Resistive Turn-on Rise Time vs. Junction Temperature**



**Fig. 12. Resistive Turn-on Rise Time vs. Collector Current**

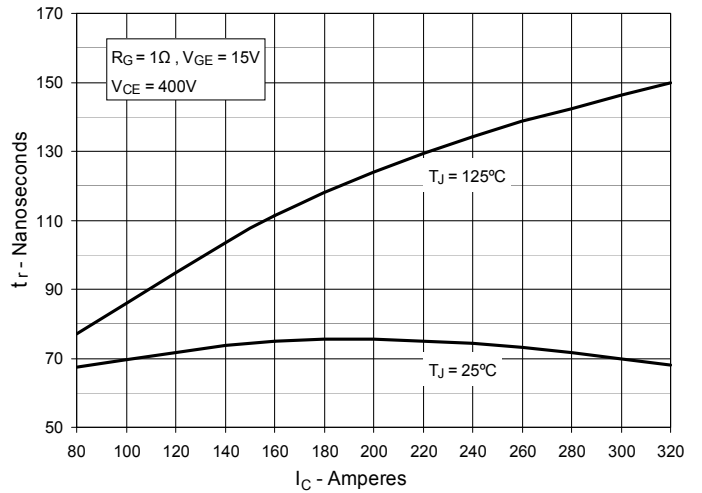

**Fig. 13. Resistive Turn-on Switching Times vs. Gate Resistance**

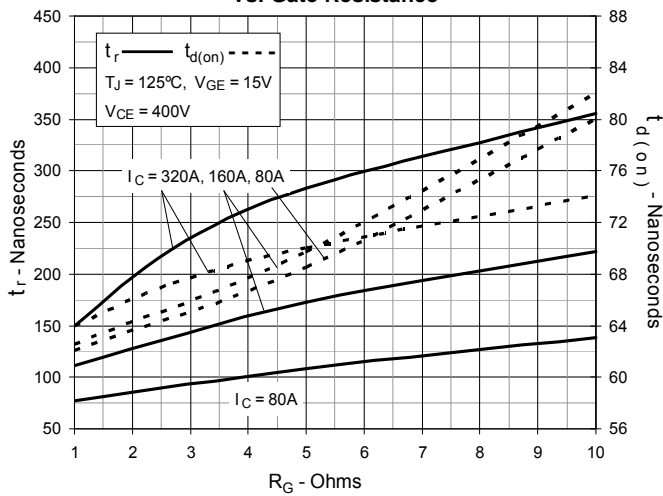

**Fig. 14. Resistive Turn-off Switching Times vs. Junction Temperature**

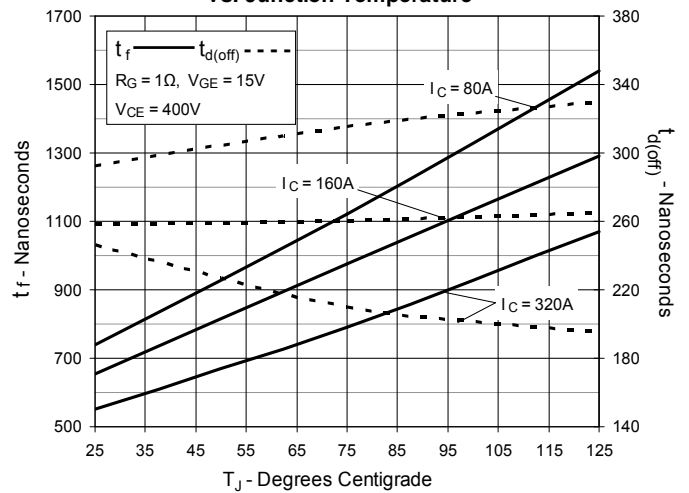

**Fig. 15. Resistive Turn-off Switching Times vs. Collector Current**

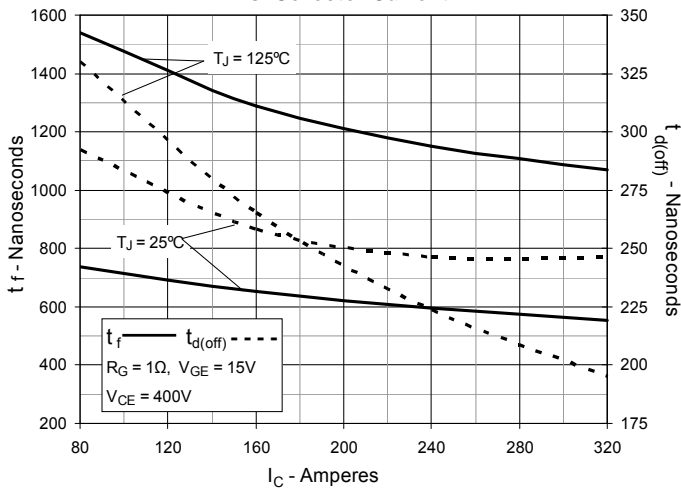

**Fig. 16. Resistive Turn-off Switching Times vs. Gate Resistance**

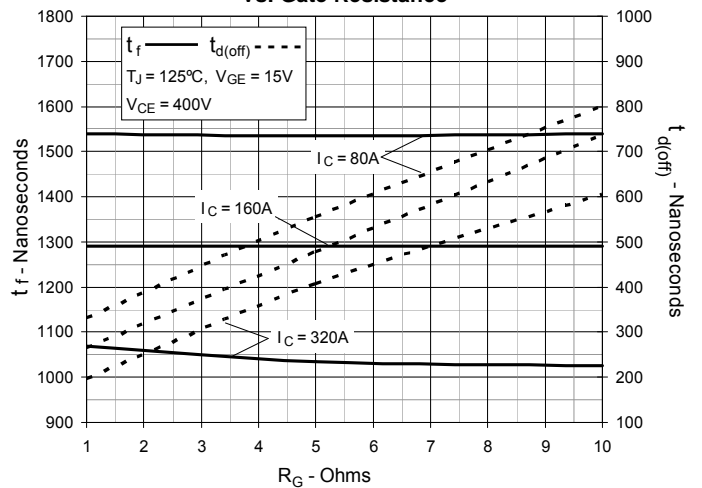



---

Disclaimer Notice - Information furnished is believed to be accurate and reliable. However, users should independently evaluate the suitability of and test each product selected for their own applications. Littelfuse products are not designed for, and may not be used in, all applications. Read complete Disclaimer Notice at [www.littelfuse.com/disclaimer-electronics](http://www.littelfuse.com/disclaimer-electronics).