

# GenX3™ 600V IGBTs w/ Diode

## IXGH30N60C3D1 IXGT30N60C3D1\*

\*Obsolete Part Number

High-Speed PT IGBTs for  
40-100 kHz Switching

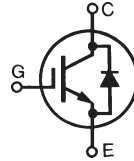

$V_{CES} = 600V$   
 $I_{C110} = 30A$   
 $V_{CE(sat)} \leq 3.0V$   
 $t_{fi(typ)} = 47ns$

Symbol	Test Conditions	Maximum Ratings	
$V_{CES}$	$T_C = 25^\circ C$ to $150^\circ C$	600	V
$V_{CGR}$	$T_J = 25^\circ C$ to $150^\circ C$ , $R_{GE} = 1M\Omega$	600	V
$V_{GES}$	Continuous	$\pm 20$	V
$V_{GEM}$	Transient	$\pm 30$	V
$I_{C25}$	$T_C = 25^\circ C$	60	A
$I_{C110}$	$T_C = 110^\circ C$	30	A
$I_{F110}$	$T_C = 110^\circ C$	30	A
$I_{CM}$	$T_C = 25^\circ C$ , 1ms	150	A
<b>SSOA</b>	$V_{GE} = 15V$ , $T_{VJ} = 125^\circ C$ , $R_G = 5\Omega$	$I_{CM} = 60$	A
<b>(RBSOA)</b>	Clamped Inductive Load	@ $\leq V_{CES}$	
$P_C$	$T_C = 25^\circ C$	220	W
$T_J$		-55 ... +150	$^\circ C$
$T_{JM}$		150	$^\circ C$
$T_{stg}$		-55 ... +150	$^\circ C$
$T_L$	1.6mm (0.062 in.) from Case for 10s	300	$^\circ C$
$T_{SOLD}$	Plastic Body for 10 seconds	260	$^\circ C$
$M_d$	Mounting Torque (TO-247)	1.13/10	Nm/lb.in.
<b>Weight</b>	TO-268	4	g
	TO-247	6	g

TO-268 (IXGT)

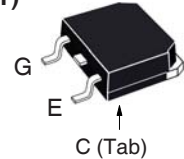

TO-247 (IXGH)

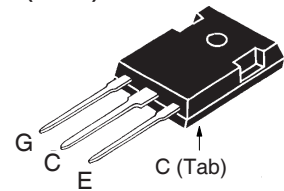

G = Gate      C = Collector  
 E = Emitter    Tab = Collector

### Features

- Optimized for Low Switching Losses
- Square RBSOA
- Anti-Parallel Ultra Fast Diode
- International Standard Packages

### Advantages

- High Power Density
- Low Gate Drive Requirement

### Applications

- High Frequency Power Inverters
- UPS
- Motor Drives
- SMPS
- PFC Circuits
- Battery Chargers
- Welding Machines
- Lamp Ballasts

Symbol	Test Conditions ( $T_J = 25^\circ C$ Unless Otherwise Specified)	Characteristic Values		
		Min.	Typ.	Max.
$V_{GE(th)}$	$I_C = 250\mu A$ , $V_{CE} = V_{GE}$	3.0		5.5 V
$I_{CES}$	$V_{CE} = V_{CES}$ , $V_{GE} = 0V$ $T_J = 125^\circ C$			75 $\mu A$ 1 mA
$I_{GES}$	$V_{CE} = 0V$ , $V_{GE} = \pm 20V$			$\pm 100$ nA
$V_{CE(sat)}$	$I_C = 20A$ , $V_{GE} = 15V$ , Note 1 $T_J = 125^\circ C$		2.6 1.8	3.0 V V

Symbol	Test Conditions ( $T_J = 25^\circ\text{C}$ , Unless Otherwise Specified)	Characteristic Values			
		Min.	Typ.	Max.	
$g_{fs}$	$I_C = 20\text{A}, V_{CE} = 10\text{V}$ , Note 1	9	30	S	
$C_{ies}$ $C_{oes}$ $C_{res}$	$V_{CE} = 25\text{V}, V_{GE} = 0\text{V}, f = 1\text{MHz}$		915	pF	
			78	pF	
			32	pF	
$Q_g$ $Q_{ge}$ $Q_{gc}$	$I_C = 20\text{A}, V_{GE} = 15\text{V}, V_{CE} = 0.5 \cdot V_{CES}$		38	nC	
			8	nC	
			17	nC	
$t_{d(on)}$ $t_{ri}$ $E_{on}$ $t_{d(off)}$ $t_{fi}$ $E_{off}$	<b>Inductive load, <math>T_J = 25^\circ\text{C}</math></b> $I_C = 20\text{A}, V_{GE} = 15\text{V}$ $V_{CE} = 300\text{V}, R_G = 5\Omega$ Note 2		16	ns	
			26	ns	
			0.27	mJ	
			42	75	ns
			47	ns	
			0.09	0.18	mJ
$t_{d(on)}$ $t_{ri}$ $E_{on}$ $t_{d(off)}$ $t_{fi}$ $E_{off}$	<b>Inductive load, <math>T_J = 125^\circ\text{C}</math></b> $I_C = 20\text{A}, V_{GE} = 15\text{V}$ $V_{CE} = 300\text{V}, R_G = 5\Omega$ Note 2		17	ns	
			28	ns	
			0.44	mJ	
			70	ns	
			90	ns	
			0.33	mJ	
$R_{thJC}$ $R_{thCS}$	TO-247	0.21	0.56	$^\circ\text{C/W}$ $^\circ\text{C/W}$	

### Reverse Diode (FRED)

Symbol	Test Conditions ( $T_J = 25^\circ\text{C}$ , Unless Otherwise Specified)	Characteristic Values		
		Min.	Typ.	Max.
$V_F$	$I_F = 30\text{A}, V_{GE} = 0\text{V}$ , Note 1		1.6	2.7 V V
$I_{RM}$ $t_{rr}$	$I_F = 30\text{A}, V_{GE} = 0\text{V}, -di_F/dt = 100\text{A}/\mu\text{s}, T_J = 100^\circ\text{C}$ $V_R = 100\text{V}, T_J = 100^\circ\text{C}$ $I_F = 1\text{A}, -di/dt = 100\text{A}/\mu\text{s}, V_R = 30\text{V}$		100	4 A ns
			25	ns
$R_{thJC}$			0.9	$^\circ\text{C/W}$

### Notes:

1. Pulse test,  $t \leq 300\mu\text{s}$ , duty cycle,  $d \leq 2\%$ .
2. Switching times & energy losses may increase for higher  $V_{CE}$  (Clamp),  $T_J$  or  $R_G$ .

### TO-268 Outline

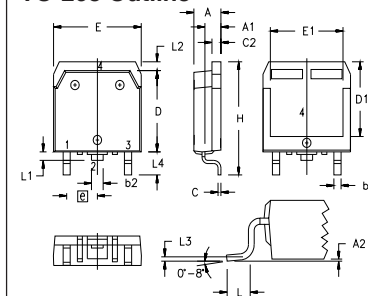

Terminals: 1 - Gate, 2,4 - Collector, 3 - Emitter

SYM	INCHES		MILLIMETERS	
	MIN	MAX	MIN	MAX
A	.193	.201	4.90	5.10
A1	.106	.114	2.70	2.90
A2	.001	.010	0.02	0.25
b	.045	.057	1.15	1.45
b2	.075	.083	1.90	2.10
C	.016	.026	0.40	0.65
C2	.057	.063	1.45	1.60
D	.543	.551	13.80	14.00
D1	.488	.500	12.40	12.70
E	.624	.632	15.85	16.05
E1	.524	.535	13.30	13.60
e	.215 BSC		5.45 BSC	
H	.736	.752	18.70	19.10
L	.094	.106	2.40	2.70
L1	.047	.055	1.20	1.40
L2	.039	.045	1.00	1.15
L3	.010 BSC		0.25 BSC	
L4	.150	.161	3.80	4.10

### TO-247 Outline

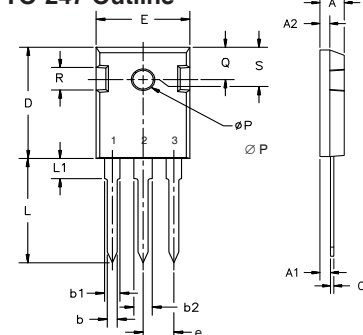

Terminals: 1 - Gate, 2 - Collector, 3 - Emitter

Dim.	Millimeter		Inches	
	Min.	Max.	Min.	Max.
A	4.7	5.3	.185	.209
A <sub>1</sub>	2.2	2.54	.087	.102
A <sub>2</sub>	2.2	2.6	.059	.098
b	1.0	1.4	.040	.055
b <sub>1</sub>	1.65	2.13	.065	.084
b <sub>2</sub>	2.87	3.12	.113	.123
C	.4	.8	.016	.031
D	20.80	21.46	.819	.845
E	15.75	16.26	.610	.640
e	5.20	5.72	0.205	0.225
L	19.81	20.32	.780	.800
L1		4.50		.177
∅P	3.55	3.65	.140	.144
Q	5.89	6.40	0.232	0.252
R	4.32	5.49	.170	.216
S	6.15	BSC	242	BSC

IXYS Reserves the Right to Change Limits, Test Conditions, and Dimensions.

IXYS MOSFETs and IGBTs are covered by one or more of the following U.S. patents:	4,835,592	4,931,844	5,049,961	5,237,481	6,162,665	6,404,065 B1	6,683,344	6,727,585	7,005,734 B2	7,157,338B2
	4,850,072	5,017,508	5,063,307	5,381,025	6,259,123 B1	6,534,343	6,710,405 B2	6,759,692	7,063,975 B2	
	4,881,106	5,034,796	5,187,117	5,486,715	6,306,728 B1	6,583,505	6,710,463	6,771,478 B2	7,071,537	

Fig. 1. Output Characteristics @  $T_J = 25^\circ\text{C}$

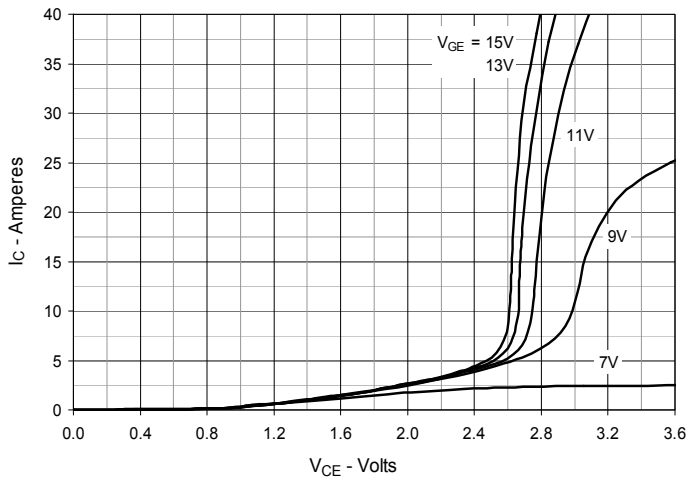

Fig. 2. Extended Output Characteristics @  $T_J = 25^\circ\text{C}$

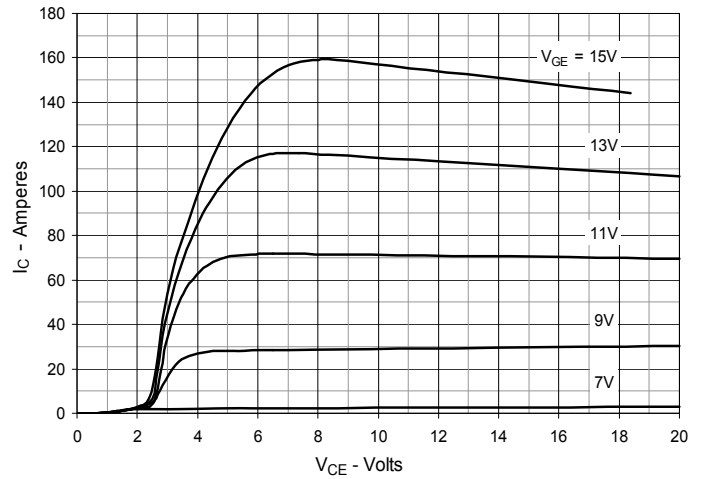

Fig. 3. Output Characteristics @  $T_J = 125^\circ\text{C}$

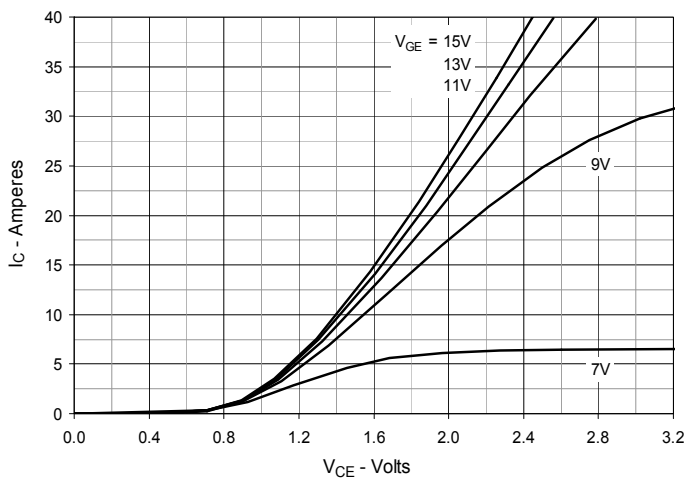

Fig. 4. Dependence of  $V_{CE(sat)}$  on Junction Temperature

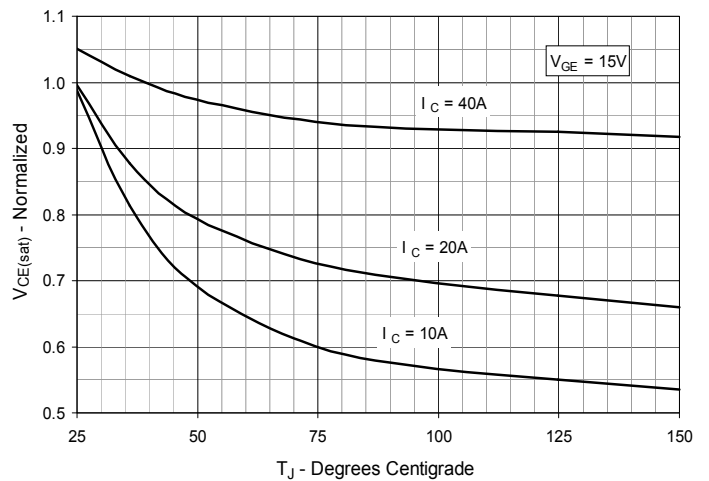

Fig. 5. Collector-to-Emitter Voltage vs. Gate-to-Emitter Voltage

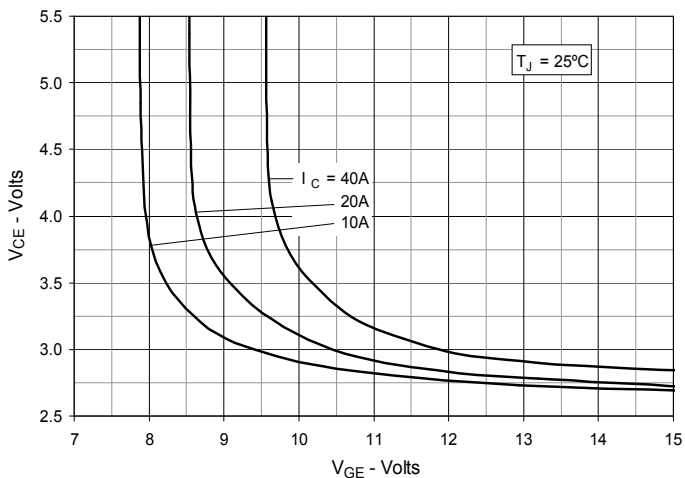

Fig. 6. Input Admittance

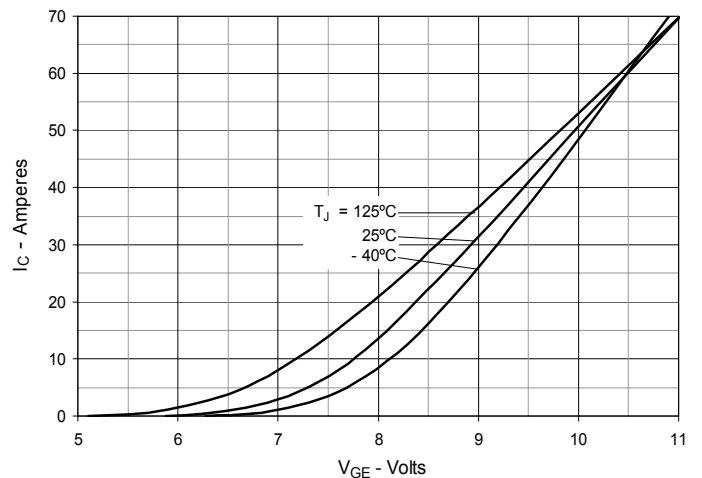

Fig. 7. Transconductance

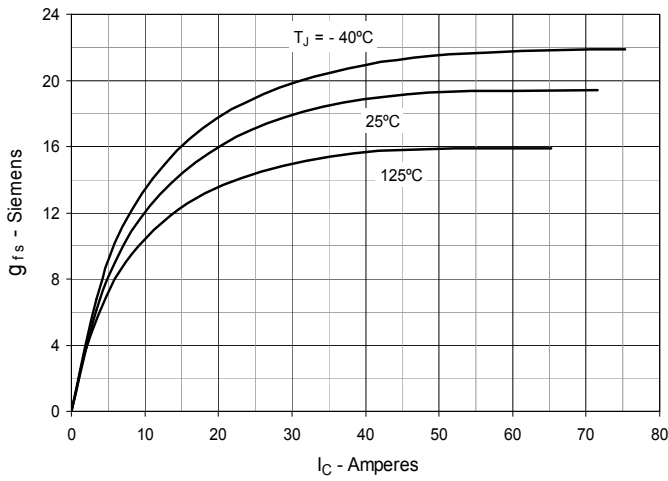

Fig. 8. Gate Charge

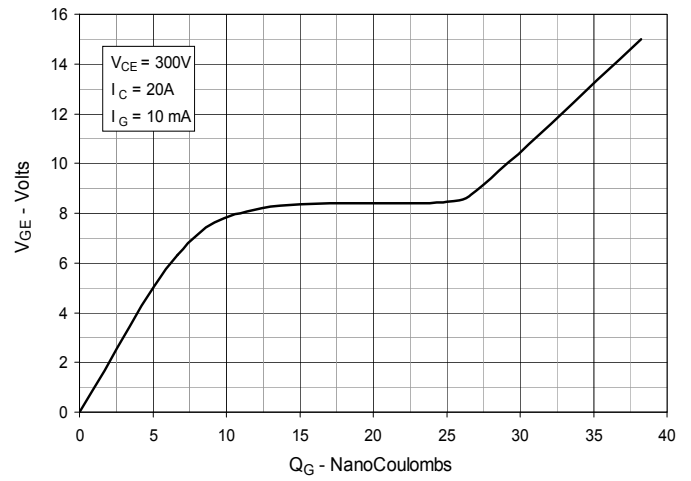

Fig. 9. Capacitance

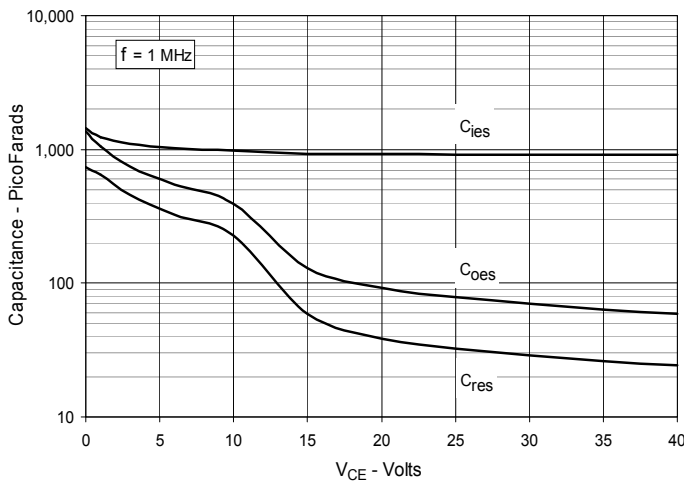

Fig. 10. Reverse-Bias Safe Operating Area

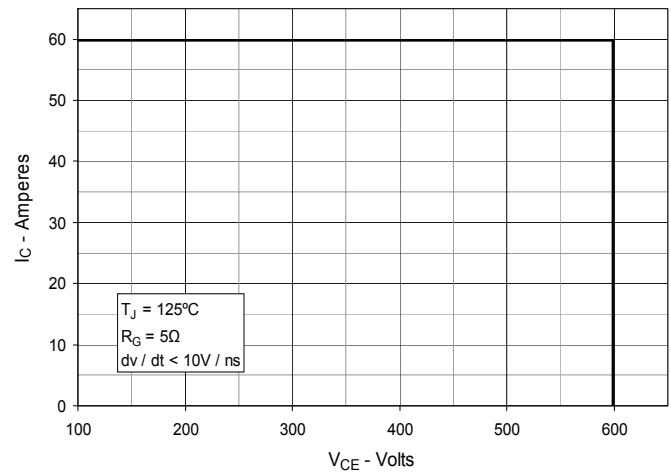
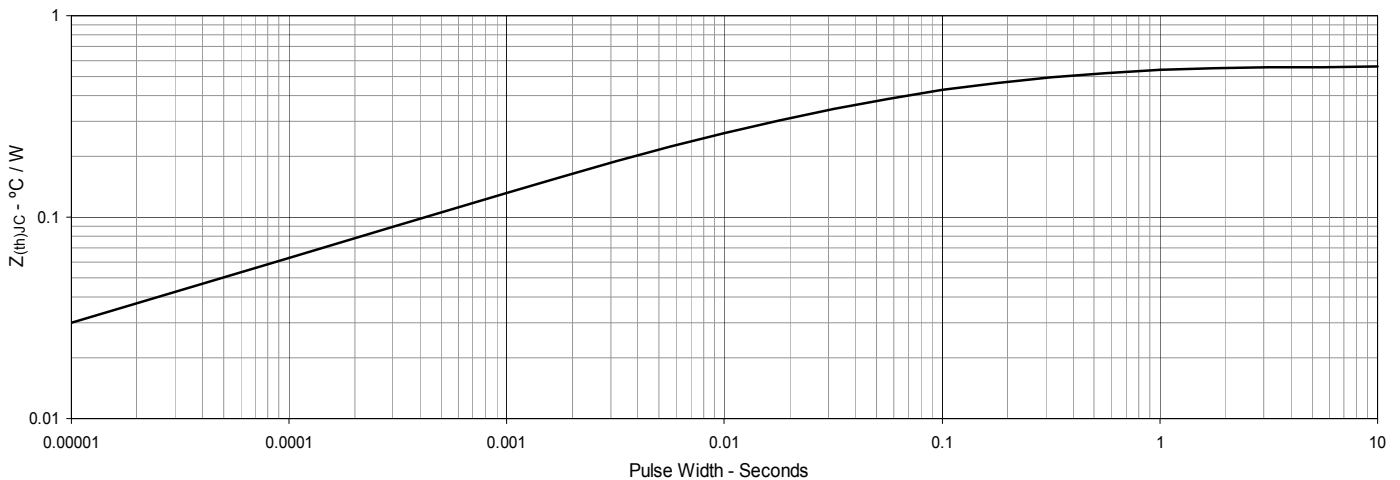
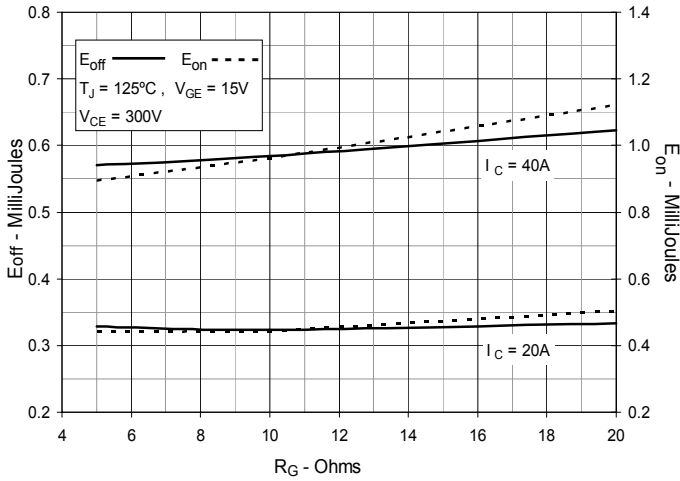

Fig. 11. Maximum Transient Thermal Impedance



**Fig. 12. Inductive Switching Energy Loss vs. Gate Resistance**



**Fig. 13. Inductive Switching Energy Loss vs. Collector Current**

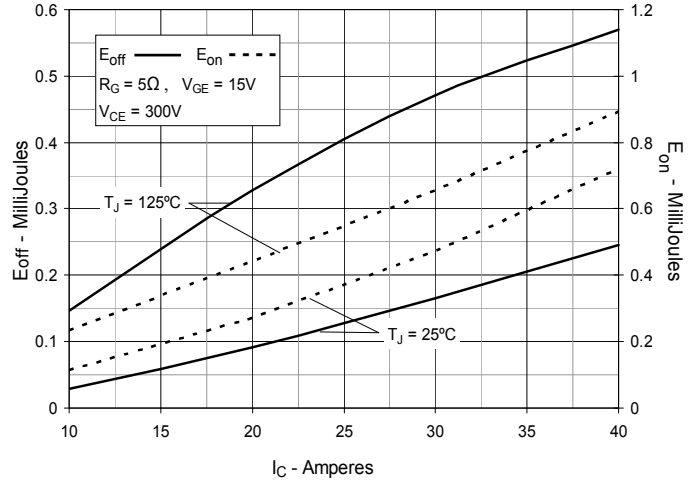

**Fig. 14. Inductive Switching Energy Loss vs. Junction Temperature**

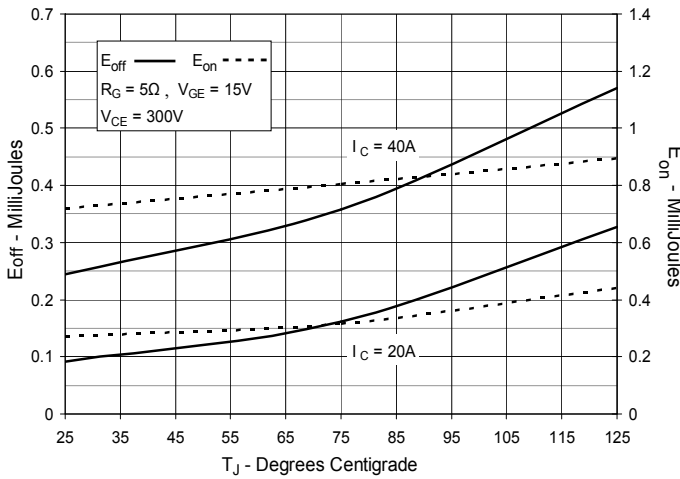

**Fig. 15. Inductive Turn-off Switching Times vs. Gate Resistance**

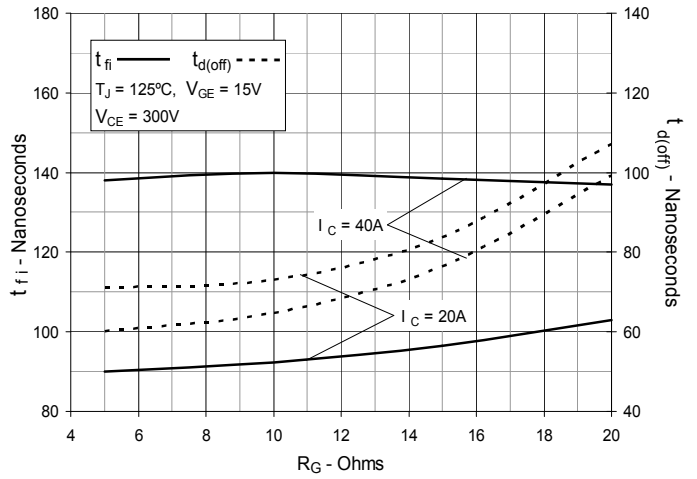

**Fig. 16. Inductive Turn-off Switching Times vs. Collector Current**

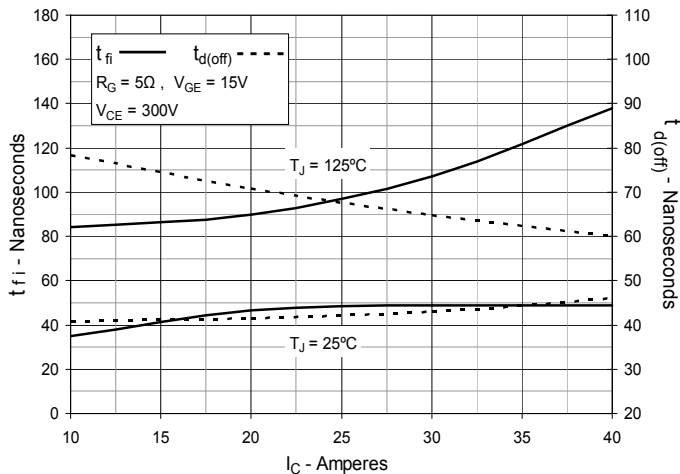

**Fig. 17. Inductive Turn-off Switching Times vs. Junction Temperature**

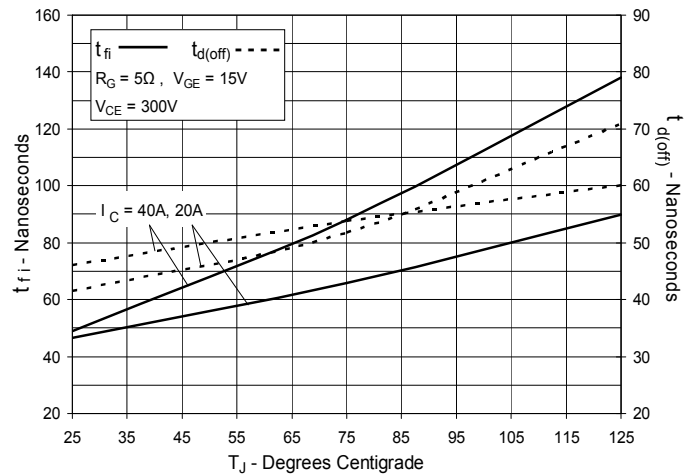

**Fig. 18. Inductive Turn-on Switching Times vs. Gate Resistance**

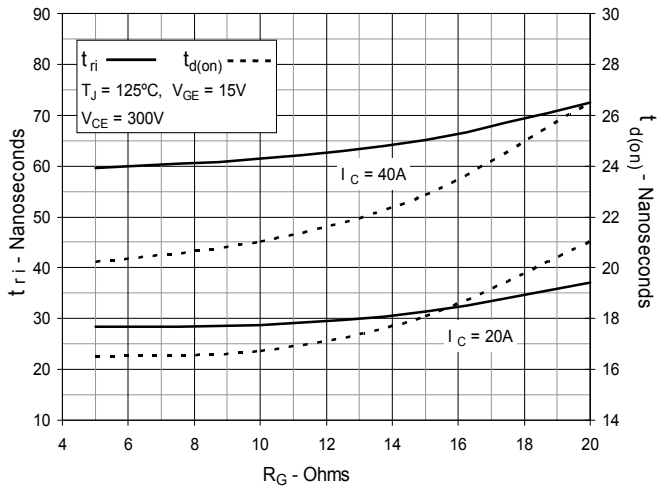

**Fig. 19. Inductive Turn-on Switching Times vs. Collector Current**

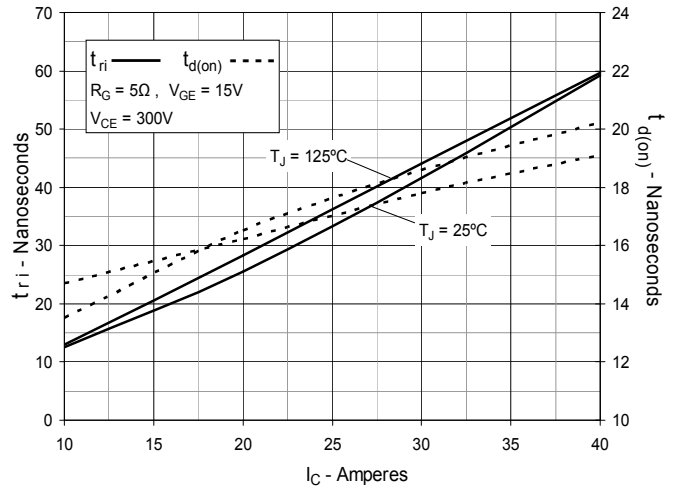

**Fig. 20. Inductive Turn-on Switching Times vs. Junction Temperature**

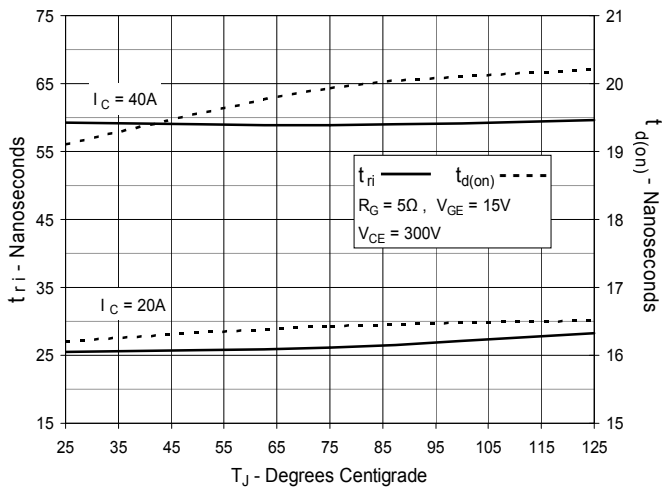

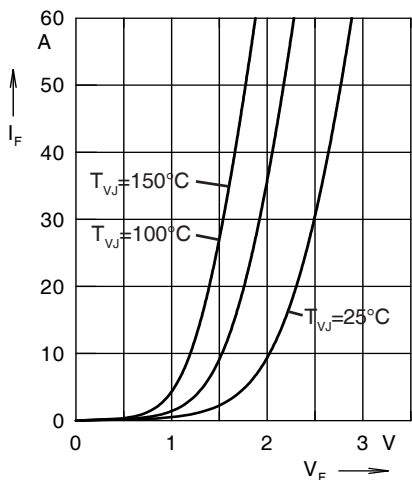

Fig. 21. Forward current  $I_F$  versus  $V_F$

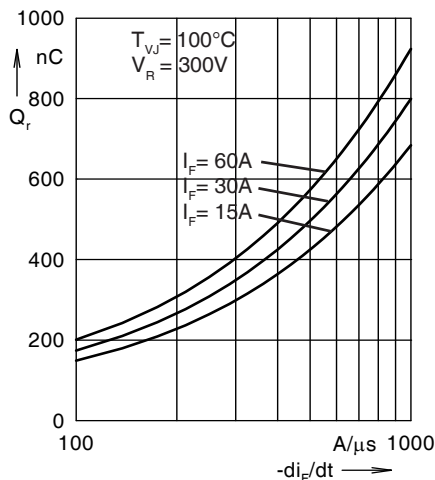

Fig. 22. Reverse recovery charge  $Q_r$  versus  $-di_F/dt$

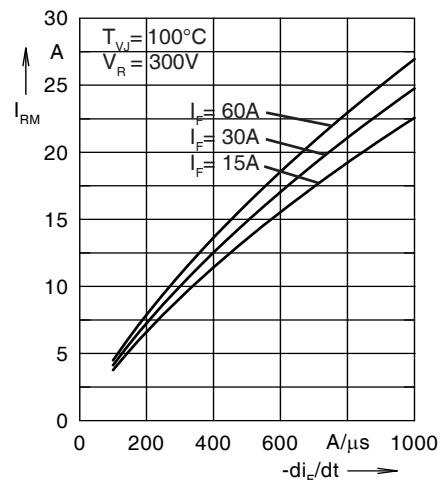

Fig. 23. Peak reverse current  $I_{RM}$  versus  $-di_F/dt$

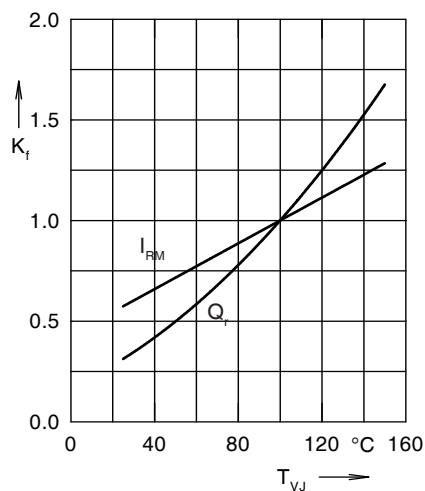

Fig. 24. Dynamic parameters  $Q_r$ ,  $I_{RM}$  versus  $T_{VJ}$

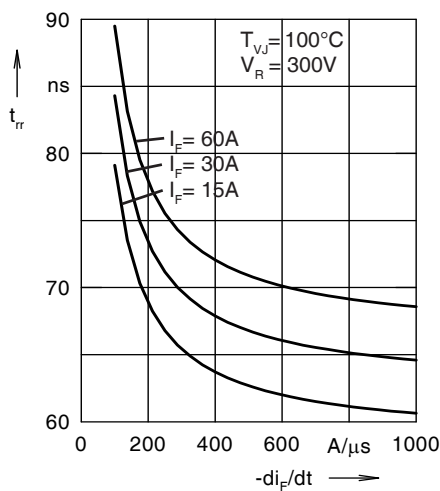

Fig. 25. Recovery time  $t_{rr}$  versus  $-di_F/dt$

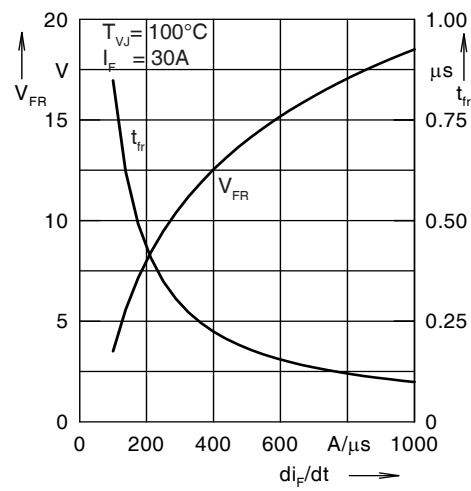

Fig. 26. Peak forward voltage  $V_{FR}$  and  $t_{rr}$  versus  $di_F/dt$

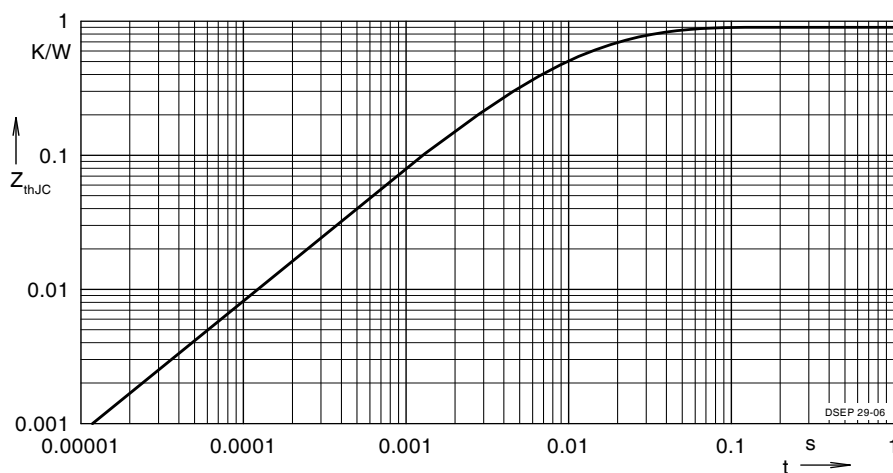

Fig. 27. Transient thermal resistance junction to case

Constants for  $Z_{thJC}$  calculation:

i	$R_{thi}$ (K/W)	$t_i$ (s)
1	0.502	0.0052
2	0.193	0.0003
3	0.205	0.0162



---

Disclaimer Notice - Information furnished is believed to be accurate and reliable. However, users should independently evaluate the suitability of and test each product selected for their own applications. Littelfuse products are not designed for, and may not be used in, all applications. Read complete Disclaimer Notice at [www.littelfuse.com/disclaimer-electronics](http://www.littelfuse.com/disclaimer-electronics).