

GenX3™ 1200V IGBT

IXGA24N120C3

IXGH24N120C3

IXGP24N120C3

High speed PT IGBTs for
10-50kHz Switching

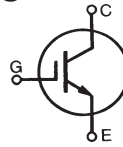

$$V_{CES} = 1200V$$

$$I_{C25} = 48A$$

$$V_{CE(sat)} \leq 4.2V$$

$$t_{fi(typ)} = 110ns$$

Symbol	Test Conditions	Maximum Ratings	
V_{CES}	$T_J = 25^\circ C$ to $150^\circ C$	1200	V
V_{CGR}	$T_J = 25^\circ C$ to $150^\circ C$, $R_{GE} = 1M\Omega$	1200	V
V_{GES}	Continuous	± 20	V
V_{GEM}	Transient	± 30	V
I_{C25}	$T_C = 25^\circ C$	48	A
I_{C100}	$T_C = 100^\circ C$	24	A
I_{CM}	$T_C = 25^\circ C$, 1ms	96	A
I_A	$T_C = 25^\circ C$	20	A
E_{AS}	$T_C = 25^\circ C$	250	mJ
SSOA (RBSOA)	$V_{GE} = 15V$, $T_J = 125^\circ C$, $R_G = 5\Omega$ Clamped inductive load @ $V_{CE} \leq 1200V$	$I_{CM} = 48$	A
P_C	$T_C = 25^\circ C$	250	W
T_J		-55 ... +150	$^\circ C$
T_{JM}		150	$^\circ C$
T_{stg}		-55 ... +150	$^\circ C$
M_d	Mounting torque	1.13/10	Nm/lb.in.
T_L	Maximum lead temperature for soldering	300	$^\circ C$
T_{SOLD}	1.6mm (0.062 in.) from case for 10s	260	$^\circ C$
Weight	TO-263	2.5	g
	TO-247	6.0	g
	TO-220	3.0	g

TO-263 (IXGA)

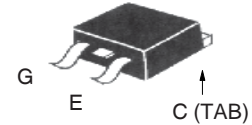

TO-247 (IXGH)

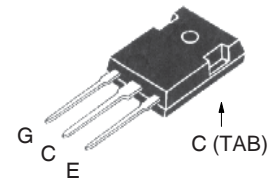

TO-220 (IXGP)

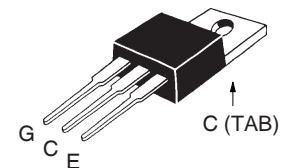

G = Gate C = Collector
E = Emitter TAB = Collector

Symbol	Test Conditions ($T_J = 25^\circ C$, unless otherwise specified)	Characteristic Values		
		Min.	Typ.	Max.
BV_{CES}	$I_C = 250\mu A$, $V_{GE} = 0V$	1200		V
$V_{GE(th)}$	$I_C = 250\mu A$, $V_{CE} = V_{GE}$	2.5		V
I_{CES}	$V_{CE} = V_{CES}$			100 μA
	$V_{GE} = 0V$ $T_J = 125^\circ C$			1.5 mA
I_{GES}	$V_{CE} = 0V$, $V_{GE} = \pm 20V$			± 100 nA
$V_{CE(sat)}$	$I_C = 20A$, $V_{GE} = 15V$, Note 2	3.6	4.2	V
	$T_J = 125^\circ C$	3.1		V

Features

- International standard packages: JEDEC TO-247AD
- MOS Gate turn-on - drive simplicity
- Avalanche rated

Applications

- AC motor speed control
- DC servo and robot drives
- DC choppers
- Uninterruptible power supplies (UPS)
- Switch-mode and resonant-mode power supplies

Symbol	Test Conditions ($T_J = 25^\circ\text{C}$, unless otherwise specified)	Characteristic Values		
		Min.	Typ.	Max.
g_{fs}	$I_C = 24\text{A}, V_{CE} = 10\text{V}$, Note 2	10	17	S
C_{ies}	$V_{CE} = 25\text{V}, V_{GE} = 0\text{V}, f = 1\text{MHz}$		1900	pF
C_{oes}			125	pF
C_{res}			52	pF
Q_g	$I_C = 24\text{A}, V_{GE} = 15\text{V}, V_{CE} = 0.5 \cdot V_{CES}$		79	nC
Q_{ge}			12	nC
Q_{gc}			36	nC
$t_{d(on)}$	Inductive load, $T_J = 25^\circ\text{C}$ $I_C = 20\text{A}, V_{GE} = 15\text{V}$ $V_{CE} = 600\text{V}, R_G = 5\Omega$ Note 1		16	ns
t_{ri}			27	ns
E_{on}			1.16	mJ
$t_{d(off)}$			93	ns
t_{fi}			110	ns
E_{off}			0.47	0.85 mJ
$t_{d(on)}$	Inductive load, $T_J = 125^\circ\text{C}$ $I_C = 20\text{A}, V_{GE} = 15\text{V}$ $V_{CE} = 600\text{V}, R_G = 5\Omega$ Note 1		16	ns
t_{ri}			35	ns
E_{on}			2.18	mJ
$t_{d(off)}$			125	ns
t_{fi}			305	ns
E_{off}			1.18	2.00 mJ
R_{thJC}	TO-220 TO-247			0.50 $^\circ\text{C/W}$
R_{thCK}			0.50	$^\circ\text{C/W}$
			0.21	$^\circ\text{C/W}$

- Notes:
- Switching times may increase for V_{CE} (Clamp) $> 0.8 \cdot V_{CES}$, higher T_J or increased R_G .
 - Pulse test, $t \leq 300\mu\text{s}$; duty cycle, $d \leq 2\%$.

TO-247 (IXGH) AD Outline

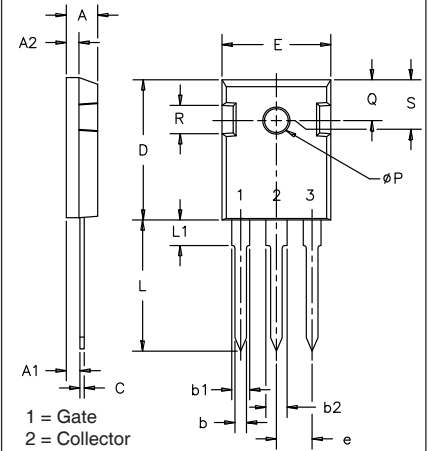

SYM	INCHES		MILLIMETERS	
	MIN	MAX	MIN	MAX
A	.185	.209	4.7	5.3
A1	.087	.102	2.2	2.54
A2	.059	.098	2.2	2.6
b	.040	.055	1.0	1.4
b1	.065	.084	1.65	2.13
b2	.113	.123	2.87	3.12
C	.016	.031	.4	.8
D	.819	.845	20.80	21.46
E	.610	.640	15.75	16.26
e	.215 BSC		5.45 BSC	
L	.780	.800	19.81	20.32
L1	.177		4.50	
ØP	.140	.144	3.55	3.65
Q	.212	.244	5.4	6.2
R	.170	.216	4.32	5.49
S	.242 BSC		6.15 BSC	

TO-220 (IXGP) Outline

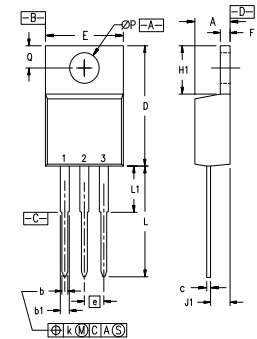

- Pins: 1 - Gate 2 - Drain
3 - Source 4 - Drain

SYM	INCHES		MILLIMETERS	
	MIN	MAX	MIN	MAX
A	.170	.190	4.32	4.83
b	.025	.040	0.64	1.02
b1	.045	.065	1.15	1.65
c	.014	.022	0.35	0.56
D	.580	.630	14.73	16.00
E	.390	.420	9.91	10.66
e	.100 BSC		2.54 BSC	
F	.045	.055	1.14	1.40
H1	.230	.270	5.85	6.85
J1	.090	.110	2.29	2.79
k	0	.015	0	0.38
L	.500	.550	12.70	13.97
L1	.110	.230	2.79	5.84
ØP	.139	.161	3.53	4.08
Q	.100	.125	2.54	3.18

TO-263 (IXGA) Outline

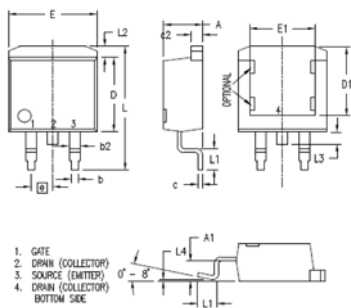

SYM	INCHES		MILLIMETERS	
	MIN	MAX	MIN	MAX
A	.160	.190	4.06	4.83
A1	.080	.110	2.03	2.79
b	.020	.039	0.51	0.99
b2	.045	.055	1.14	1.40
c	.016	.029	0.40	0.74
c2	.045	.055	1.14	1.40
D	.340	.380	8.64	9.65
D1	.315	.350	8.00	8.89
E	.380	.410	9.65	10.41
E1	.245	.320	6.22	8.13
e	.100 BSC		2.54 BSC	
L	.575	.625	14.61	15.88
L1	.090	.110	2.29	2.79
L2	.040	.055	1.02	1.40
L3	.050	.070	1.27	1.78
L4	0	.005	0	0.13

PRELIMINARY TECHNICAL INFORMATION

The product presented herein is under development. The Technical Specifications offered are derived from data gathered during objective characterizations of preliminary engineering lots; but also may yet contain some information supplied during a pre-production design evaluation. IXYS reserves the right to change limits, test conditions, and dimensions without notice.

IXYS reserves the right to change limits, test conditions, and dimensions.

IXYS MOSFETs and IGBTs are covered 4,835,592 4,931,844 5,049,961 5,237,481 6,162,665 6,404,065 B1 6,683,344 6,727,585 7,005,734 B2 7,157,338B2
by one or more of the following U.S. patents: 4,850,072 5,017,508 5,063,307 5,381,025 6,259,123 B1 6,534,343 6,710,405 B2 6,759,692 7,063,975 B2
4,881,106 5,034,796 5,187,117 5,486,715 6,306,728 B1 6,583,505 6,710,463 6,771,478 B2 7,071,537

Fig. 1. Output Characteristics @ 25°C

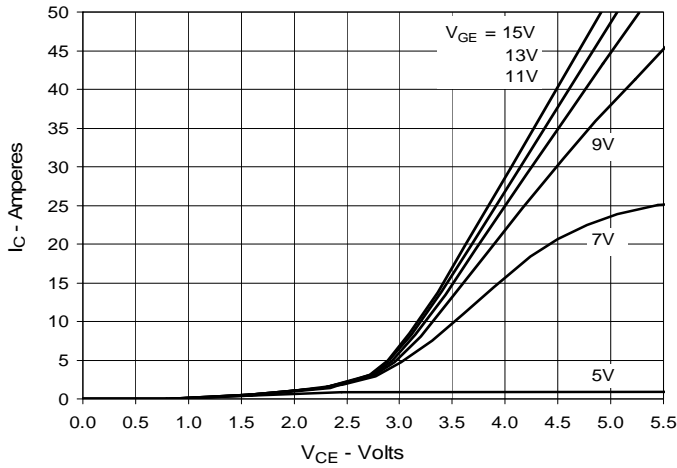

Fig. 2. Extended Output Characteristics @ 25°C

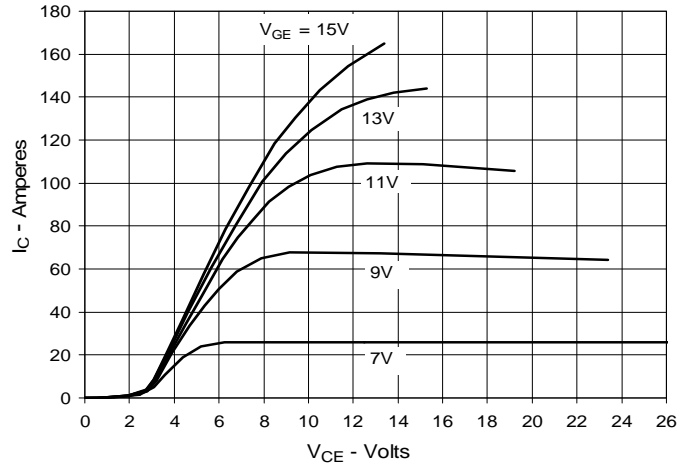

Fig. 3. Output Characteristics @ 125°C

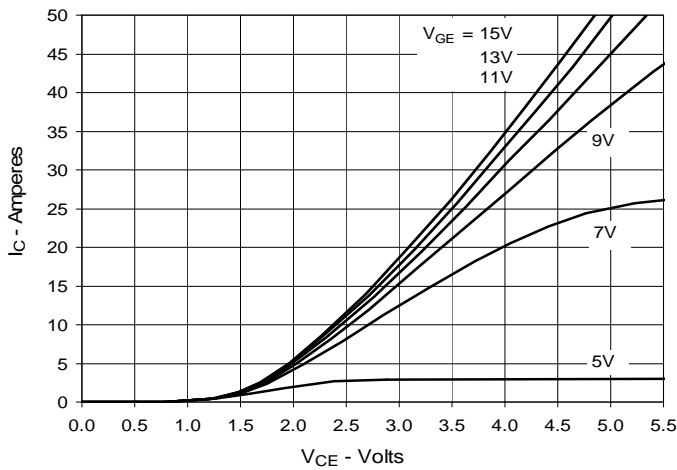

Fig. 4. Dependence of VCE(sat) on Junction Temperature

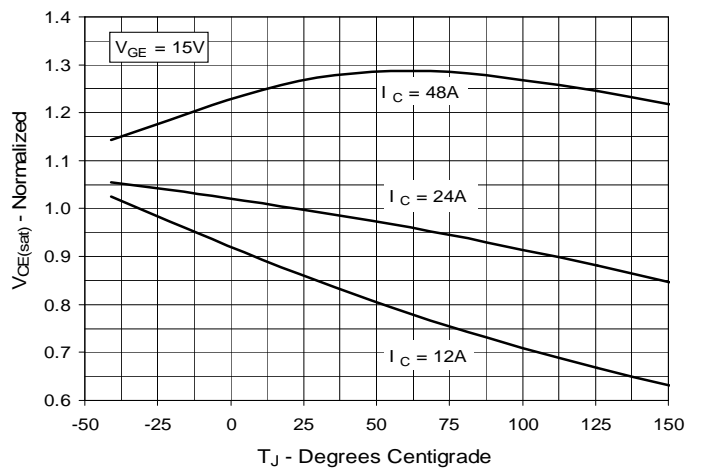

Fig. 5. Collector-to-Emitter Voltage vs. Gate-to-Emitter Voltage

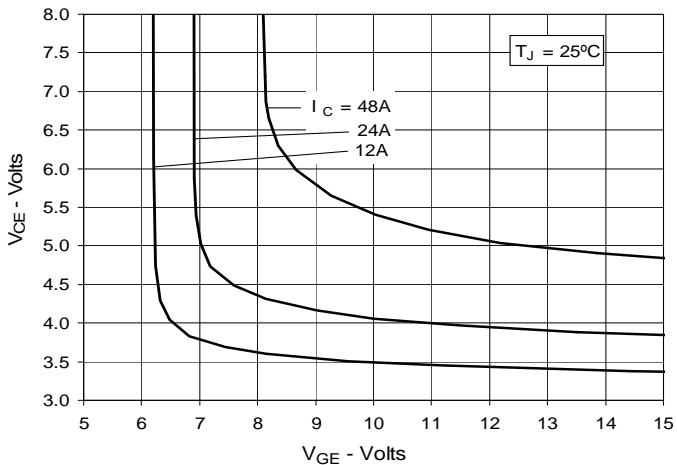

Fig. 6. Input Admittance

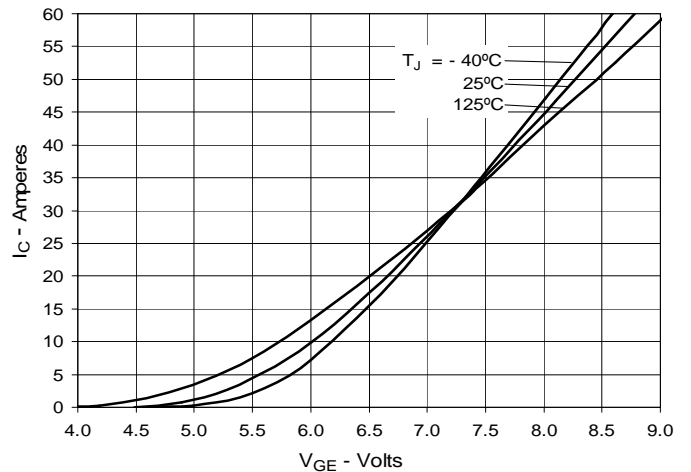

Fig. 7. Transconductance

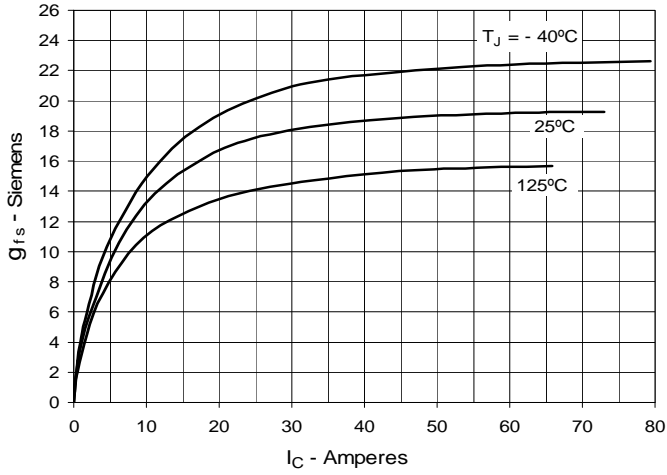

Fig. 8. Gate Charge

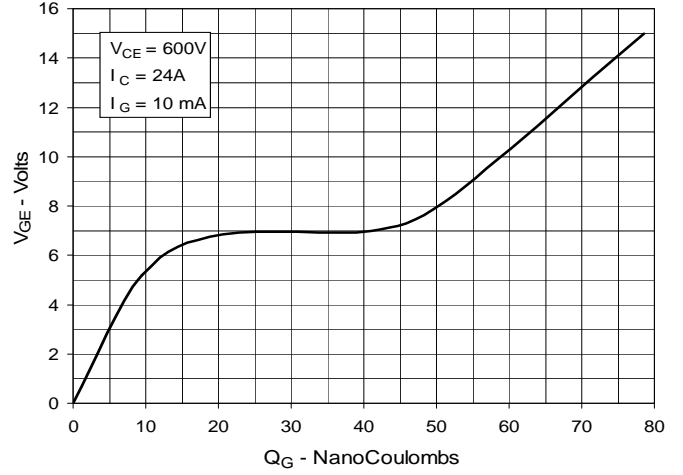

Fig. 9. Capacitance

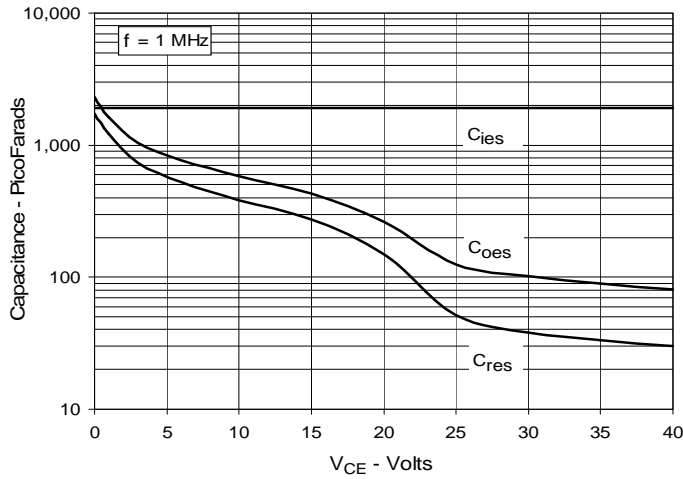

Fig. 10. Reverse-Bias Safe Operating Area

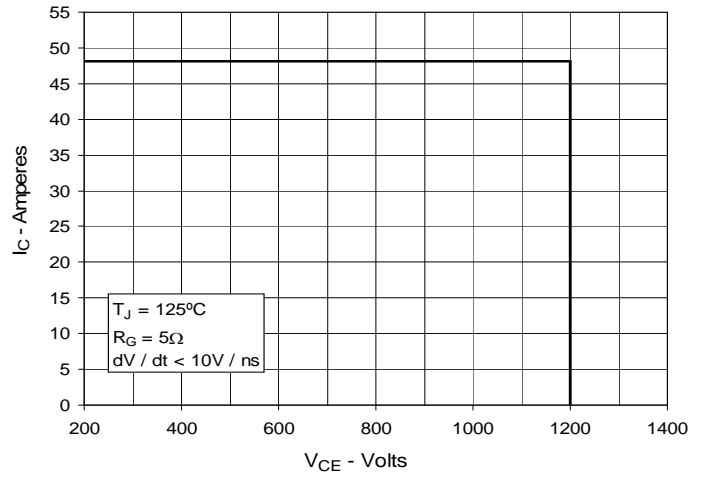
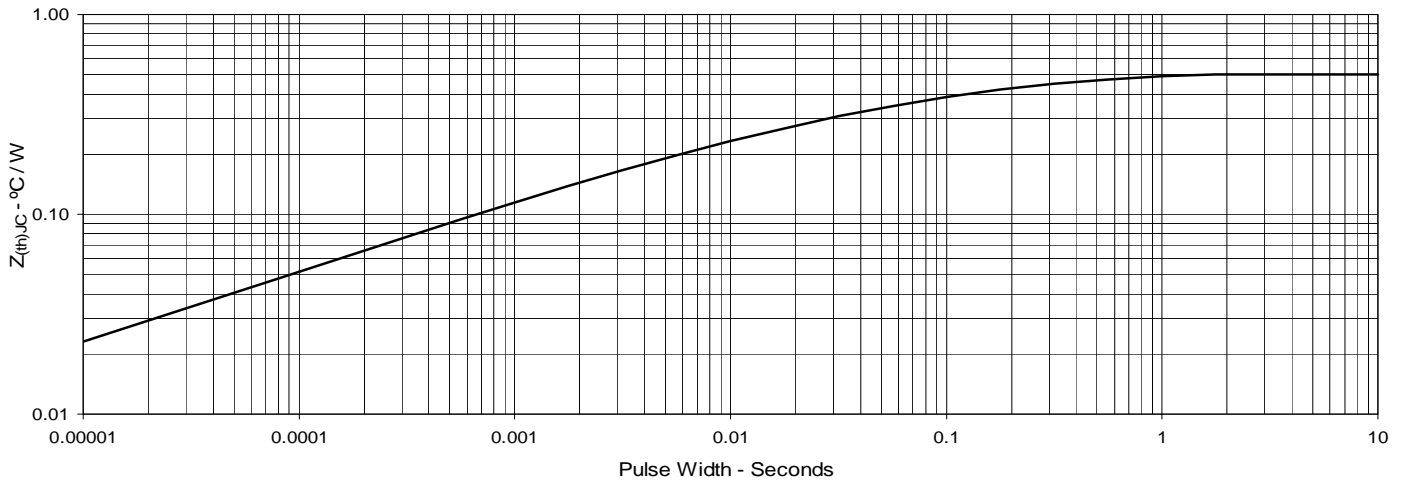

Fig. 11. Maximum Transient Thermal Impedance



IXYS reserves the right to change limits, test conditions, and dimensions.

Fig. 12. Inductive Switching Energy Loss vs. Gate Resistance



Fig. 13. Inductive Switching Energy Loss vs. Collector Current

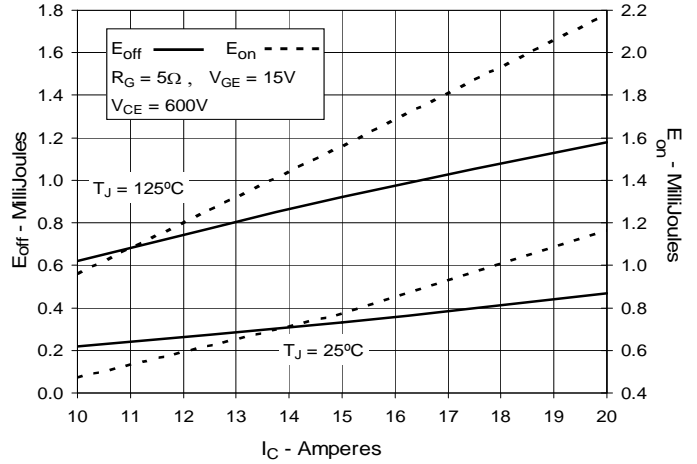

Fig. 14. Inductive Switching Energy Loss vs. Junction Temperature



Fig. 15. Inductive Turn-off Switching Times vs. Gate Resistance

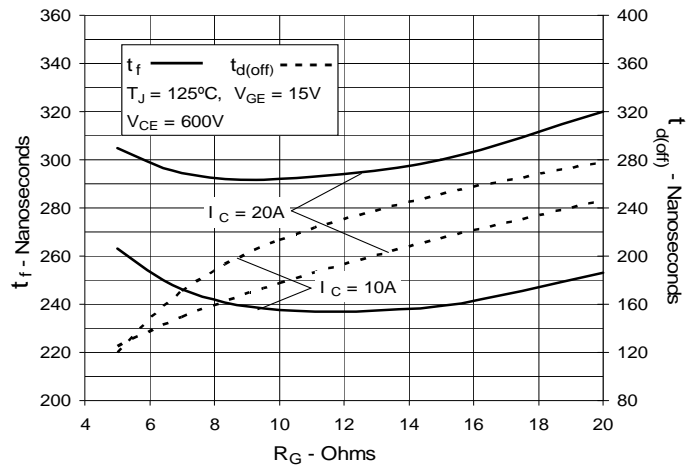
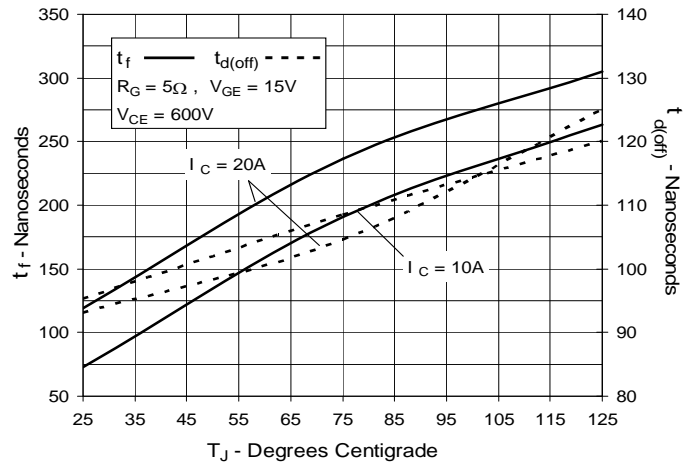

Fig. 16. Inductive Turn-off Switching Times vs. Collector Current



Fig. 17. Inductive Turn-off Switching Times vs. Junction Temperature



**Fig. 18. Inductive Turn-on
Switching Times vs. Gate Resistance**

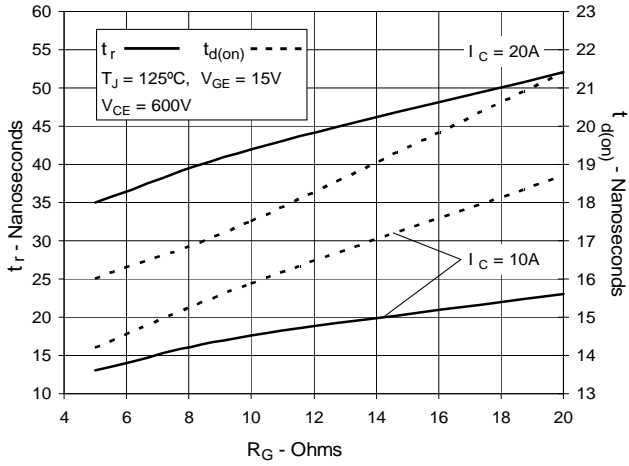

**Fig. 19. Inductive Turn-on
Switching Times vs. Collector Current**

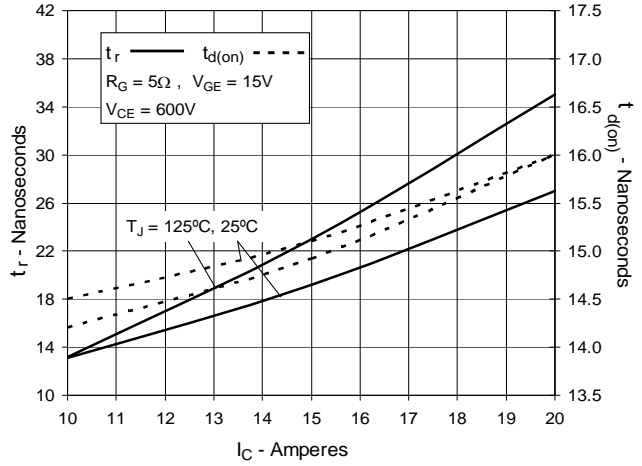

**Fig. 20. Inductive Turn-on
Switching Times vs. Junction Temperature**

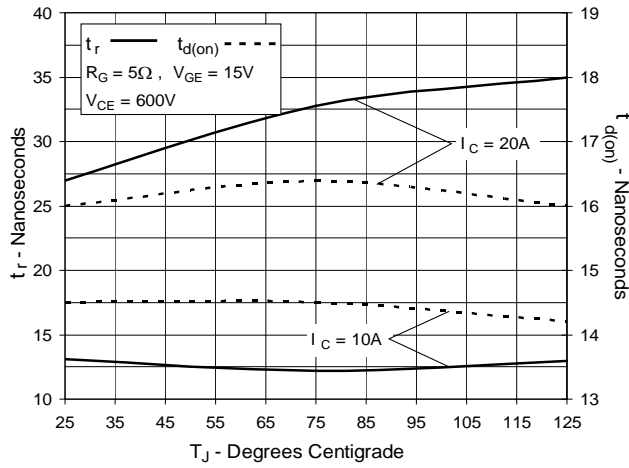



Disclaimer Notice - Information furnished is believed to be accurate and reliable. However, users should independently evaluate the suitability of and test each product selected for their own applications. Littelfuse products are not designed for, and may not be used in, all applications. Read complete Disclaimer Notice at www.littelfuse.com/disclaimer-electronics.