

# GenX3™ 1200V IGBTs

**IXGA12N120A3**  
**IXGP12N120A3**  
**IXGH12N120A3**

$V_{CES} = 1200V$   
 $I_{C90} = 12A$   
 $V_{CE(sat)} \leq 3.0V$

High Surge Current

Ultra-Low  $V_{sat}$  PT IGBTs for up to 3kHz Switching

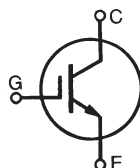

Symbol	Test Conditions	Maximum Ratings	
$V_{CES}$	$T_J = 25^\circ C$ to $150^\circ C$	1200	V
$V_{CGR}$	$T_J = 25^\circ C$ to $150^\circ C$ , $R_{GE} = 1M\Omega$	1200	V
$V_{GES}$	Continuous	$\pm 20$	V
$V_{GEM}$	Transient	$\pm 30$	V
$I_{C25}$	$T_C = 25^\circ C$	22	A
$I_{C90}$	$T_C = 90^\circ C$	12	A
$I_{CM}$	$T_C = 25^\circ C$ , 1ms	60	A
<b>SSOA</b> <b>(RBSOA)</b>	$V_{GE} = 15V$ , $T_{VJ} = 125^\circ C$ , $R_G = 10\Omega$ Clamped Inductive Load	$I_{CM} = 24$ $V_{CE} \leq 0.8 \cdot V_{CES}$	A
$P_C$	$T_C = 25^\circ C$	100	W
$T_J$		-55 ... +150	$^\circ C$
$T_{JM}$		150	$^\circ C$
$T_{stg}$		-55 ... +150	$^\circ C$
$T_L$	Maximum Lead Temperature for Soldering	300	$^\circ C$
$T_{SOLD}$	1.6 mm (0.062in.) from Case for 10s	260	$^\circ C$
$F_C$	Mounting Force (TO-263)	10..65 / 2.2..14.6	N/lb.
$M_d$	Mounting Torque (TO-220 & TO-247)	1.13 / 10	Nm/lb.in.
<b>Weight</b>	TO-263	2.5	g
	TO-220	3.0	g
	TO-247	6.0	g

Symbol	Test Conditions ( $T_J = 25^\circ C$ , Unless Otherwise Specified)	Characteristic Values		
		Min.	Typ.	Max.
$BV_{CES}$	$I_C = 250\mu A$ , $V_{GE} = 0V$	1200		V
$V_{GE(th)}$	$I_C = 250\mu A$ , $V_{CE} = V_{GE}$	2.5		5.0 V
$I_{CES}$	$V_{CE} = V_{CES}$ , $V_{GE} = 0V$ $T_J = 125^\circ C$			10 $\mu A$ 275 $\mu A$
$I_{GES}$	$V_{CE} = 0V$ , $V_{GE} = \pm 20V$			$\pm 100$ nA
$V_{CE(sat)}$	$I_C = I_{C90}$ , $V_{GE} = 15V$ , Note 1 $T_J = 125^\circ C$		2.40 2.75	V V

TO-263 AA (IXGA)

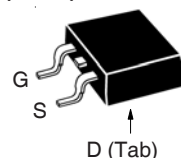

TO-220AB (IXGP)

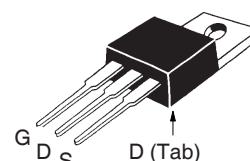

TO-247 (IXGH)

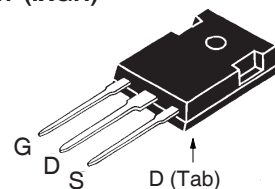

G = Gate      D = Drain  
 S = Source    Tab = Drain

### Features

- Optimized for Low Conduction Losses
- International Standard Packages

### Advantages

- High Power Density
- Low Gate Drive Requirement

### Applications

- Power Inverters
- UPS
- Motor Drives
- SMPS
- PFC Circuits
- Battery Chargers
- Welding Machines
- Lamp Ballasts
- Inrush Current Protection Circuits

Symbol	Test Conditions ( $T_J = 25^\circ\text{C}$ , Unless Otherwise Specified)	Characteristic Values		
		Min.	Typ.	Max.
$g_{fs}$	$I_C = I_{C90}, V_{CE} = 10\text{V}$ , Note 1	5.2	8.8	S
$I_{C(on)}$	$V_{GE} = 10\text{V}, V_{CE} = 10\text{V}$ , Note 1		44	A
$C_{ies}$	$V_{CE} = 25\text{V}, V_{GE} = 0\text{V}, f = 1\text{MHz}$		550	pF
$C_{oes}$			30	pF
$C_{res}$			8	pF
$Q_g$	$I_C = I_{C90}, V_{GE} = 15\text{V}, V_{CE} = 600\text{V}$		20.4	nC
$Q_{ge}$			3.1	nC
$Q_{gc}$			8.5	nC
$t_{d(on)}$	<b>Resistive Switching Times, <math>T_J = 25^\circ\text{C}</math></b> $I_C = I_{C90}, V_{GE} = 15\text{V}$ $V_{CE} = 960\text{V}, R_G = 10\Omega$		35	ns
$t_r$			140	ns
$t_{d(off)}$			62	ns
$t_f$			1035	ns
$t_{d(on)}$	<b>Resistive Switching Times, <math>T_J = 125^\circ\text{C}</math></b> $I_C = I_{C90}, V_{GE} = 15\text{V}$ $V_{CE} = 960\text{V}, R_G = 10\Omega$		35	ns
$t_r$			167	ns
$t_{d(off)}$			70	ns
$t_f$			1475	ns
$R_{thJC}$				1.25 $^\circ\text{C/W}$
$R_{thCS}$	TO-247		0.21	$^\circ\text{C/W}$
	TO-220		0.50	$^\circ\text{C/W}$

**TO-263 Outline**

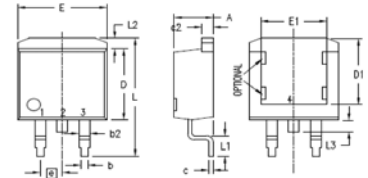

- 1 = Gate
- 2 = Collector
- 3 = Emitter
- 4 = Collector

SYM	INCHES		MILLIMETERS	
	MIN	MAX	MIN	MAX
A	.160	.190	4.06	4.83
A1	.080	.110	2.03	2.79
b	.020	.039	0.51	0.99
b2	.045	.055	1.14	1.40
c	.016	.029	0.40	0.74
c2	.045	.055	1.14	1.40
D	.340	.380	8.64	9.65
D1	.315	.350	8.00	8.89
E	.380	.410	9.65	10.41
E1	.245	.320	6.22	8.13
e	.100 BSC		2.54 BSC	
L	.575	.625	14.61	15.88
L1	.090	.110	2.29	2.79
L2	.040	.055	1.02	1.40
L3	.050	.070	1.27	1.78
L4	0	.005	0	0.13

Note 1. Pulse test,  $t \leq 300\mu\text{s}$ , duty cycle,  $d \leq 2\%$ .

**TO-247 Outline**

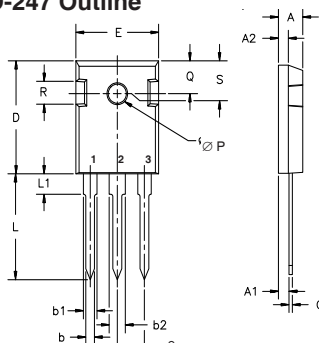

- Terminals: 1 - Gate
- 2 - Collector
- 3 - Emitter

Dim.	Millimeter		Inches	
	Min.	Max.	Min.	Max.
A	4.7	5.3	.185	.209
A <sub>1</sub>	2.2	2.54	.087	.102
A <sub>2</sub>	2.2	2.6	.059	.098
b	1.0	1.4	.040	.055
b <sub>1</sub>	1.65	2.13	.065	.084
b <sub>2</sub>	2.87	3.12	.113	.123
C	.4	.8	.016	.031
D	20.80	21.46	.819	.845
E	15.75	16.26	.610	.640
e	5.20	5.72	0.205	0.225
L	19.81	20.32	.780	.800
L1		4.50		.177
∅P	3.55	3.65	.140	.144
Q	5.89	6.40	0.232	0.252
R	4.32	5.49	.170	.216
S	6.15	BSC	242	BSC

**TO-220 Outline**

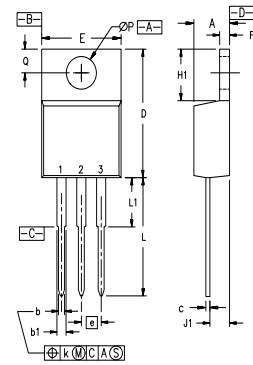

- 1 = Gate
- 2 = Collector
- 3 = Emitter

SYM	INCHES		MILLIMETERS	
	MIN	MAX	MIN	MAX
A	.170	.190	4.32	4.83
b	.025	.040	0.64	1.02
b1	.045	.065	1.15	1.65
c	.014	.022	0.35	0.56
D	.580	.630	14.73	16.00
E	.390	.420	9.91	10.66
e	.100 BSC		2.54 BSC	
F	.045	.055	1.14	1.40
H1	.230	.270	5.85	6.85
J1	.090	.110	2.29	2.79
k	0	.015	0	0.38
L	.500	.550	12.70	13.97
L1	.110	.230	2.79	5.84
∅P	.139	.161	3.53	4.08
Q	.100	.125	2.54	3.18

IXYS Reserves the Right to Change Limits, Test Conditions, and Dimensions.

IXYS MOSFETs and IGBTs are covered by one or more of the following U.S. patents:	4,835,592	4,931,844	5,049,961	5,237,481	6,162,665	6,404,065 B1	6,683,344	6,727,585	7,005,734 B2	7,157,338B2
	4,850,072	5,017,508	5,063,307	5,381,025	6,259,123 B1	6,534,343	6,710,405 B2	6,759,692	7,063,975 B2	
	4,881,106	5,034,796	5,187,117	5,486,715	6,306,728 B1	6,583,505	6,710,463	6,771,478 B2	7,071,537	

**Fig. 1. Output Characteristics @  $T_J = 25^\circ\text{C}$**

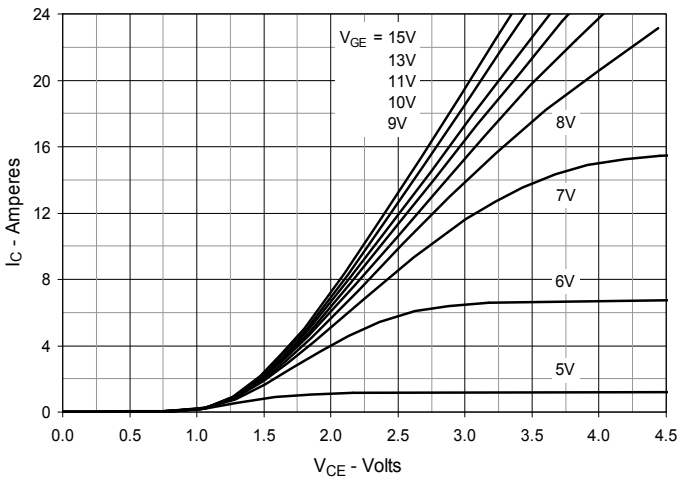

**Fig. 2. Extended Output Characteristics @  $T_J = 25^\circ\text{C}$**

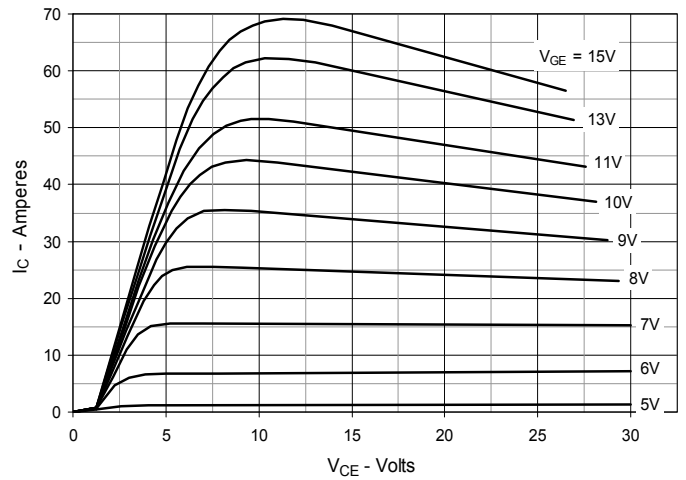

**Fig. 3. Output Characteristics @  $T_J = 125^\circ\text{C}$**

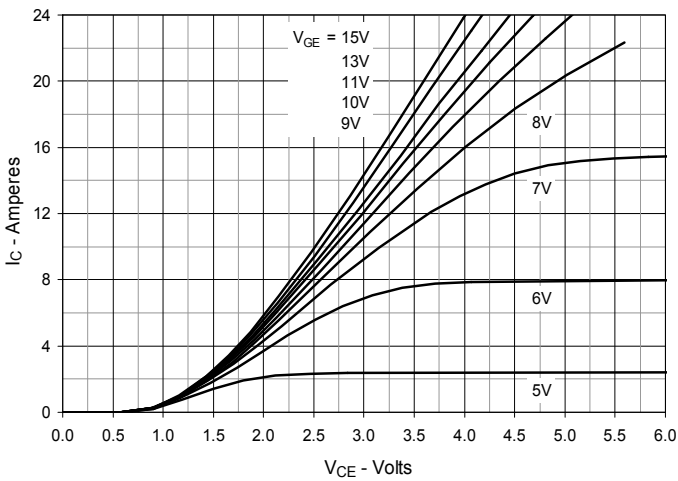

**Fig. 4. Dependence of  $V_{CE(sat)}$  on Junction Temperature**

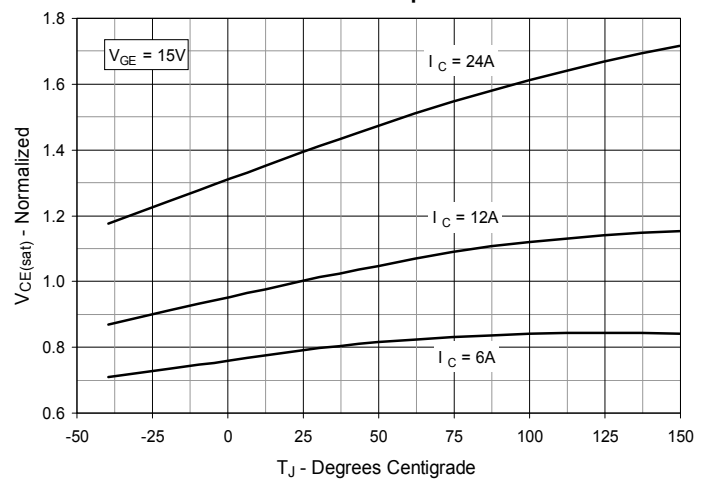

**Fig. 5. Collector-to-Emitter Voltage vs. Gate-to-Emitter Voltage**

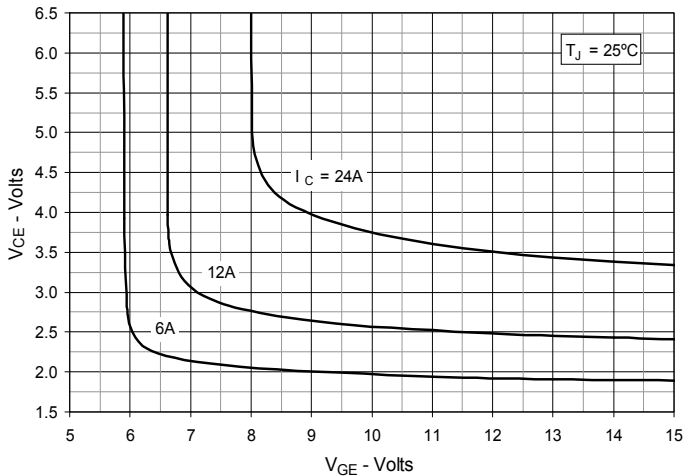

**Fig. 6. Input Admittance**

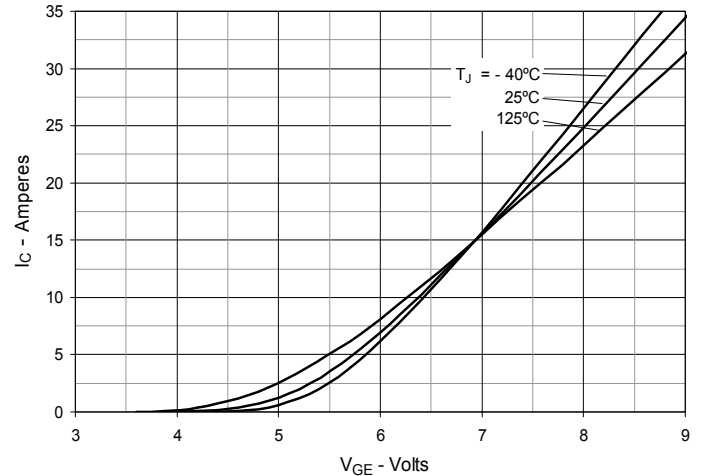

**Fig. 7. Transconductance**

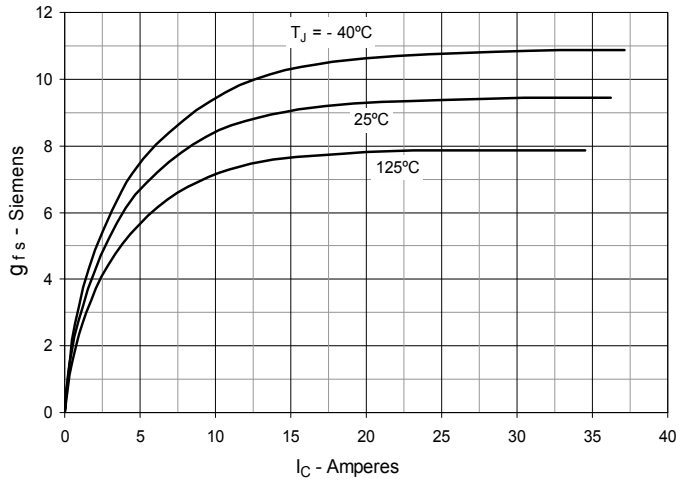

**Fig. 8. Gate Charge**

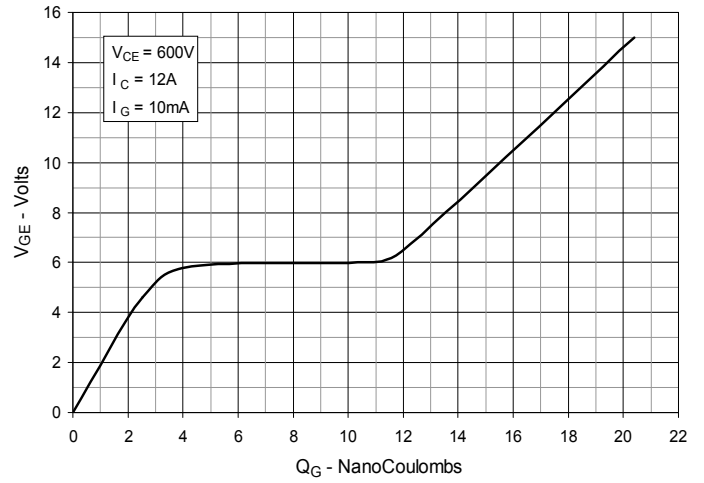

**Fig. 9. Reverse-Bias Safe Operating Area**

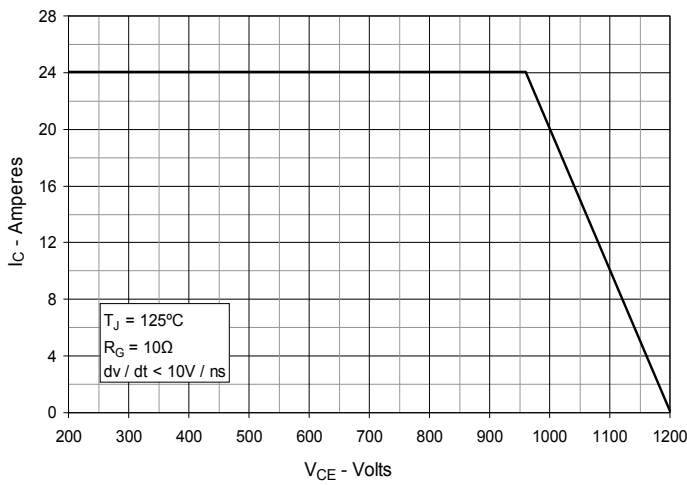

**Fig. 10. Capacitance**

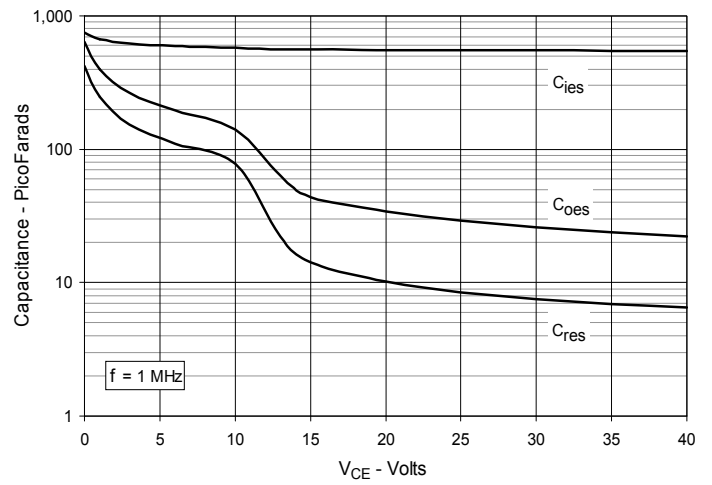

**Fig. 11. Maximum Transient Thermal Impedance**

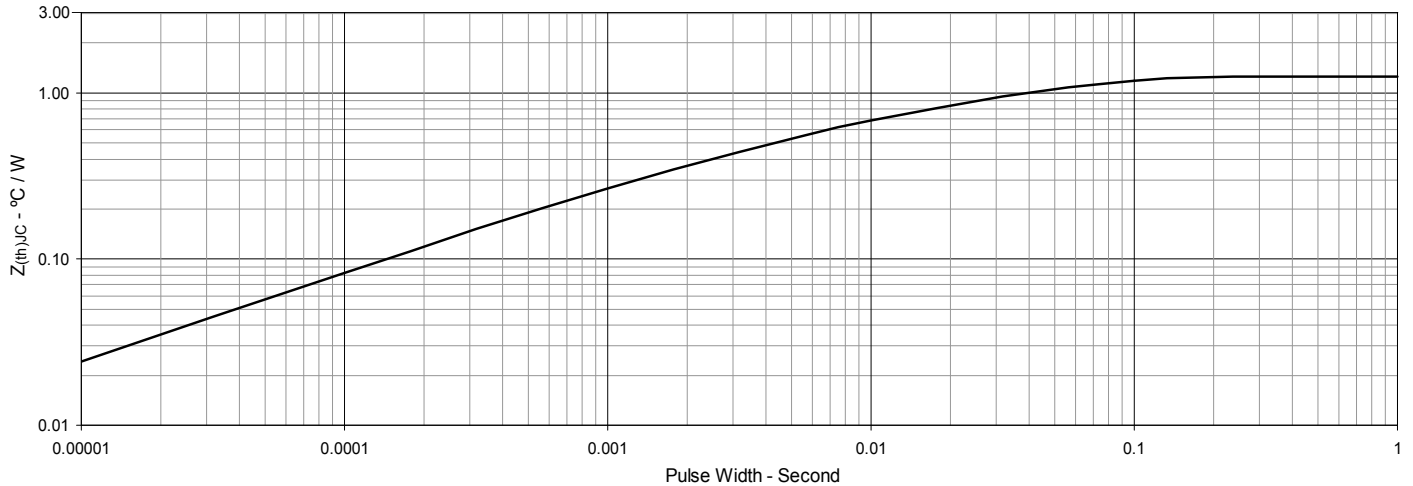

**Fig. 12. Resistive Turn-on Rise Time vs. Junction Temperature**

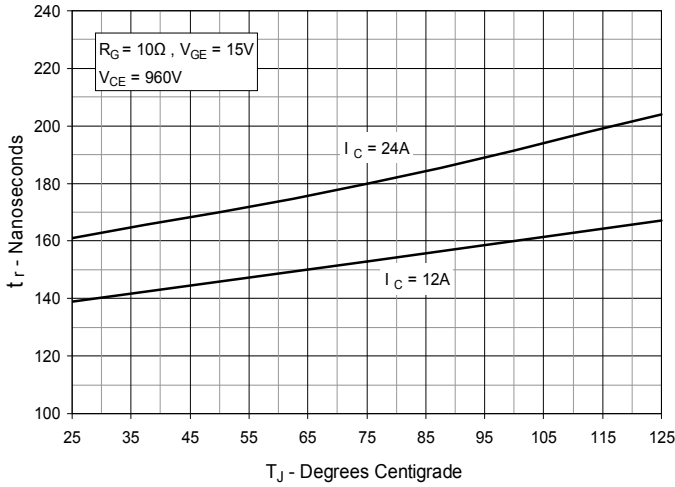

**Fig. 13. Resistive Turn-on Rise Time vs. Collector Current**

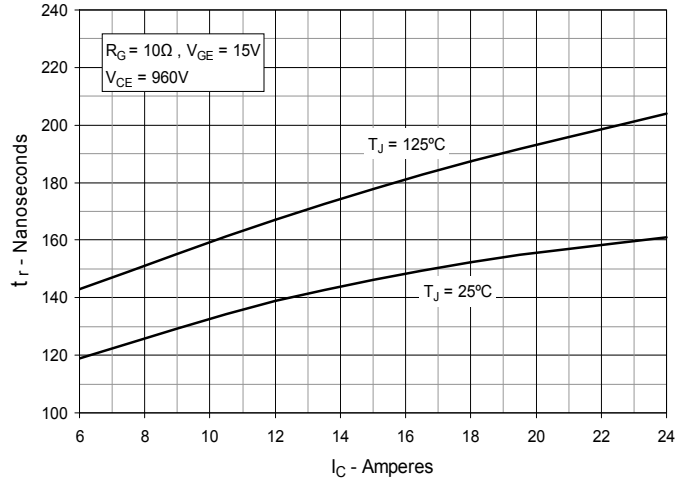

**Fig. 14. Resistive Turn-on Switching Times vs. Gate Resistance**

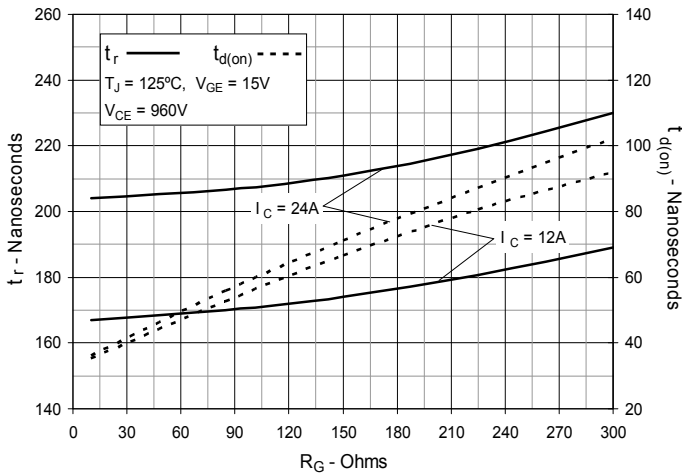

**Fig. 15. Resistive Turn-off Switching Times vs. Junction Temperature**

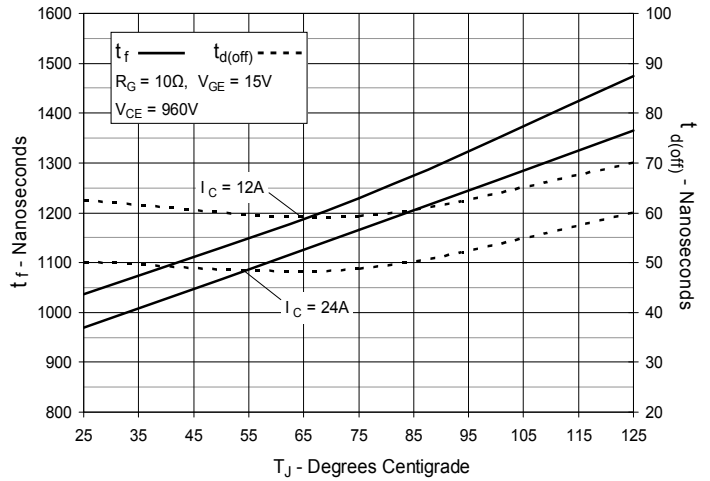

**Fig. 16. Resistive Turn-off Switching Times vs. Collector Current**

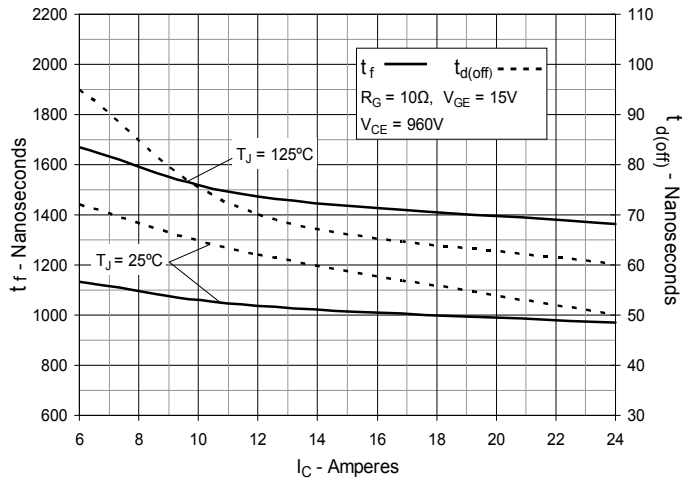

**Fig. 17. Resistive Turn-off Switching Times vs. Gate Resistance**

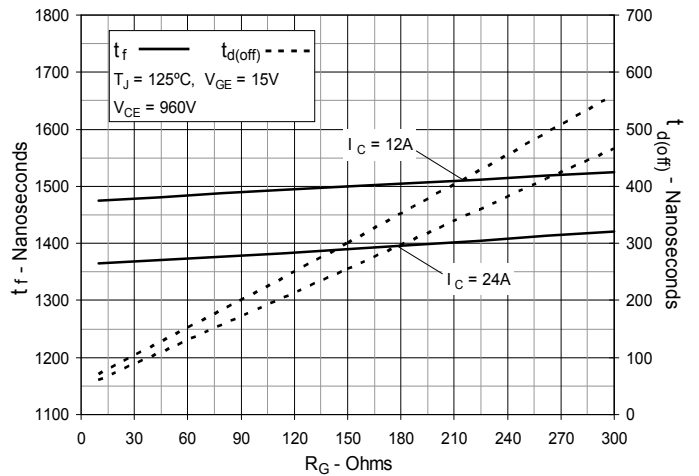



---

Disclaimer Notice - Information furnished is believed to be accurate and reliable. However, users should independently evaluate the suitability of and test each product selected for their own applications. Littelfuse products are not designed for, and may not be used in, all applications. Read complete Disclaimer Notice at [www.littelfuse.com/disclaimer-electronics](http://www.littelfuse.com/disclaimer-electronics).