

GenX3™ A3-Class IGBTs

Ultra-Low V_{sat} PT IGBTs for
up to 5kHz Switching

IXGK120N60A3*
IXGX120N60A3
*Obsolete Part Number

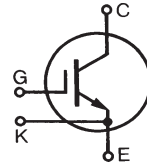

V_{CES} = 600V
I_{C110} = 120A
V_{CE(sat)} ≤ 1.35V

Symbol	Test Conditions	Maximum Ratings	
V _{CES}	T _J = 25°C to 150°C	600	V
V _{CGR}	T _J = 25°C to 150°C, R _{GE} = 1MΩ	600	V
V _{GES}	Continuous	±20	V
V _{GEM}	Transient	±30	V
I _{C25}	T _C = 25°C	200	A
I _{C110}	T _C = 110°C	120	A
I _{LRMS}	Terminal Current Limit	75	A
I _{CM}	T _C = 25°C, 1ms	600	A
SSOA (RBSOA)	V _{GE} = 15V, T _{VJ} = 125°C, R _G = 1.5Ω Clamped Inductive Load	I _{CM} = 200 @ ≤ 600	A V
P _C	T _C = 25°C	780	W
T _J		-55 ... +150	°C
T _{JM}		150	°C
T _{stg}		-55 ... +150	°C
T _L	Maximum Lead Temperature for Soldering	300	°C
T _{SOLD}	1.6 mm (0.062 in.) from Case for 10	260	°C
M _d	Mounting Torque (IXGK)	1.13/10	Nm/lb.in.
F _c	Mounting Force (IXGX)	20..120/4.5..27	N/lb.
Weight	TO-264	10	g
	PLUS247	6	g

TO-264 (IXGK)

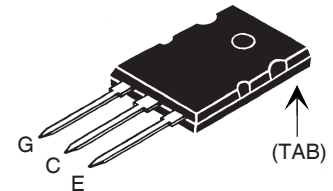

PLUS 247™ (IXGX)

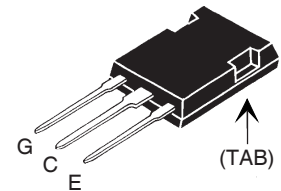

G = Gate E = Emitter
C = Collector TAB = Collector

Features

- Optimized for Low Conduction Losses
- Square RBSOA
- High Current Handling Capability
- International Standard Packages

Advantages

- High Power Density
- Low Gate Drive Requirement

Applications

- Power Inverters
- UPS
- Motor Drives
- SMPS
- PFC Circuits
- Battery Chargers
- Welding Machines
- Lamp Ballasts
- Inrush Current Protection Circuits

Symbol	Test Conditions (T _J = 25°C, Unless Otherwise Specified)	Characteristic Values		
		Min.	Typ.	Max.
V _{GE(th)}	I _C = 500μA, V _{CE} = V _{GE}	3.0		5.0 V
I _{CES}	V _{CE} = V _{CES} , V _{GE} = 0V T _J = 125°C			50 μA 1.25 mA
I _{GES}	V _{CE} = 0V, V _{GE} = ±20V			±400 nA
V _{CE(sat)}	I _C = 100A, V _{GE} = 15V, Note 1		1.20	1.35 V

Symbol	Test Conditions	Characteristic Values		
		Min.	Typ.	Max.
g_{fs}	$I_C = 60A, V_{CE} = 10V$, Note 1	65	108	S
C_{ies}	$V_{CE} = 25V, V_{GE} = 0V, f = 1MHz$		14.8	nF
C_{oes}			800	pF
C_{res}			140	pF
$Q_{g(on)}$	$I_C = I_{C110}, V_{GE} = 15V, V_{CE} = 0.5 \cdot V_{CES}$		450	nC
Q_{ge}			67	nC
Q_{gc}			130	nC
$t_{d(on)}$	Inductive load, $T_J = 25^\circ C$ $I_C = 100A, V_{GE} = 15V$ $V_{CE} = 480V, R_G = 1.5\Omega$		39	ns
t_{ri}			82	ns
E_{on}			2.7	mJ
$t_{d(off)}$			295	ns
t_{fi}			260	ns
E_{off}			6.6	mJ
$t_{d(on)}$	Inductive load, $T_J = 125^\circ C$ $I_C = 100A, V_{GE} = 15V$ $V_{CE} = 480V, R_G = 1.5\Omega$		40	ns
t_{ri}			83	ns
E_{on}			3.5	mJ
$t_{d(off)}$			420	ns
t_{fi}			410	ns
E_{off}			10.4	mJ
R_{thJC}			0.16	$^\circ C/W$
R_{thCK}		0.15		$^\circ C/W$

TO-264 (IXGK) Outline

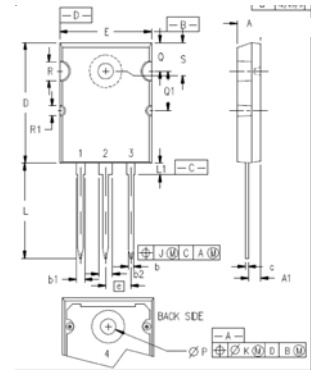

1 - GATE
2, 4 - DRAIN (COLLECTOR)
3 - SOURCE (EMITTER)

SYM	INCHES		MILLIMETERS	
	MIN	MAX	MIN	MAX
A	.185	.209	4.70	5.31
A1	.102	.118	2.59	3.00
b	.037	.055	0.94	1.40
b1	.087	.102	2.21	2.59
b2	.110	.126	2.79	3.20
c	.017	.029	0.43	0.74
D	1.007	1.047	25.58	26.59
E	.760	.799	19.30	20.29
e	.215BSC		5.46 BSC	
J	.000	.010	0.00	0.25
K	.000	.010	0.00	0.25
L	.779	.842	19.79	21.39
L1	.087	.102	2.21	2.59
$\varnothing P$.122	.138	3.10	3.51
Q	.240	.256	6.10	6.50
Q1	.330	.346	8.38	8.79
$\varnothing R$.155	.187	3.94	4.75
$\varnothing R1$.085	.093	2.16	2.36
S	.243	.253	6.17	6.43

PLUS 247™ (IXGX) Outline

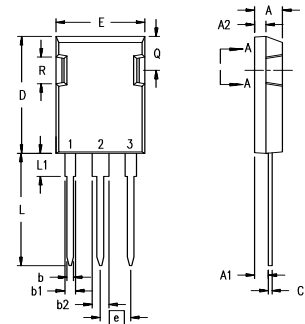

Terminals: 1 - Gate
2 - Drain (Collector)
3 - Source (Emitter)

Dim.	Millimeter		Inches	
	Min.	Max.	Min.	Max.
A	4.83	5.21	.190	.205
A ₁	2.29	2.54	.090	.100
A ₂	1.91	2.16	.075	.085
b	1.14	1.40	.045	.055
b ₁	1.91	2.13	.075	.084
b ₂	2.92	3.12	.115	.123
C	0.61	0.80	.024	.031
D	20.80	21.34	.819	.840
E	15.75	16.13	.620	.635
e	5.45 BSC		.215 BSC	
L	19.81	20.32	.780	.800
L1	3.81	4.32	.150	.170
Q	5.59	6.20	.220	0.244

Note: 1. Pulse Test, $t \leq 300\mu s$; Duty Cycle, $d \leq 2\%$.

IXYS Reserves the Right to Change Limits, Test Conditions, and Dimensions.

IXYS MOSFETs and IGBTs are covered by one or more of the following U.S. patents:

4,835,592	4,931,844	5,049,961	5,237,481	6,162,665	6,404,065 B1	6,683,344	6,727,585	7,005,734 B2	7,157,338B2
4,850,072	5,017,508	5,063,307	5,381,025	6,259,123 B1	6,534,343	6,710,405 B2	6,759,692	7,063,975 B2	
4,881,106	5,034,796	5,187,117	5,486,715	6,306,728 B1	6,583,505	6,710,463	6,771,478 B2	7,071,537	

Fig. 1. Output Characteristics @ 25°C

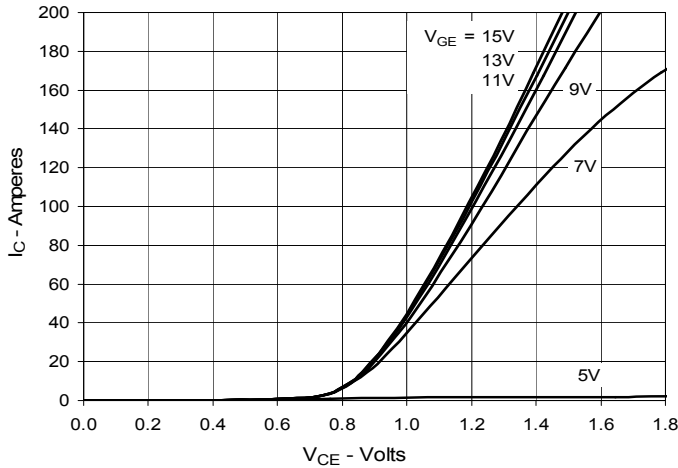

Fig. 2. Extended Output Characteristics @ 25°C

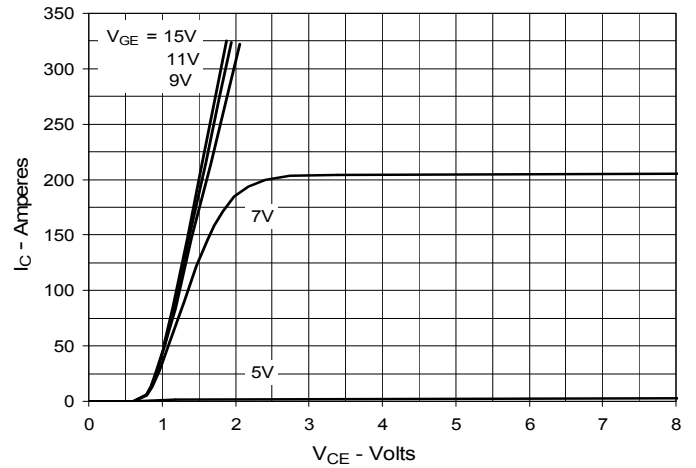

Fig. 3. Output Characteristics @ 125°C

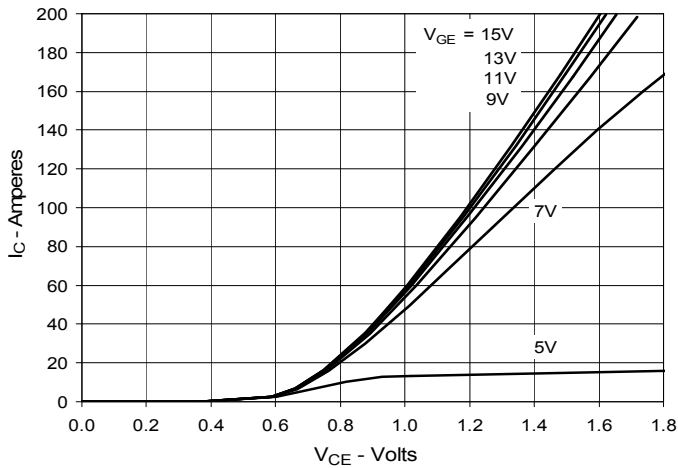

Fig. 4. Dependence of $V_{CE(sat)}$ on Junction Temperature

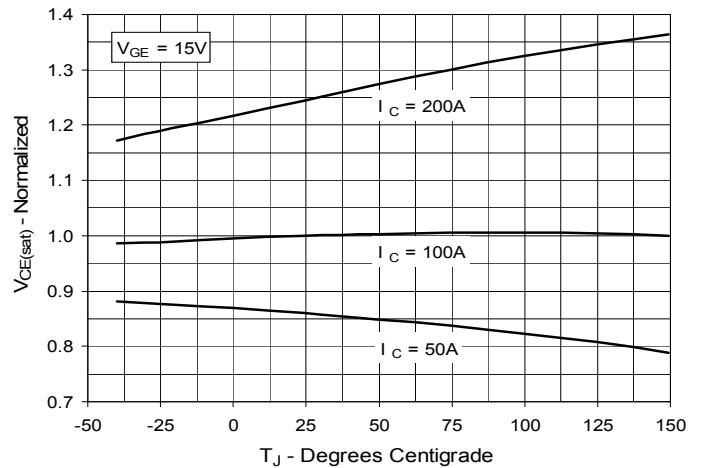

Fig. 5. Collector-to-Emitter Voltage vs. Gate-to-Emitter Voltage

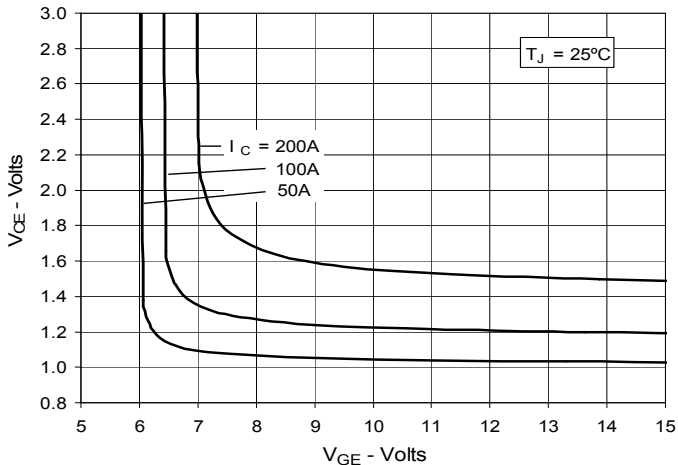

Fig. 6. Input Admittance

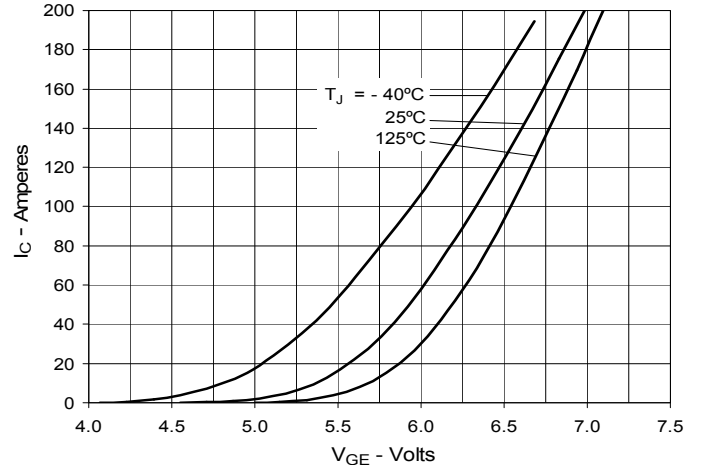

Fig. 7. Transconductance

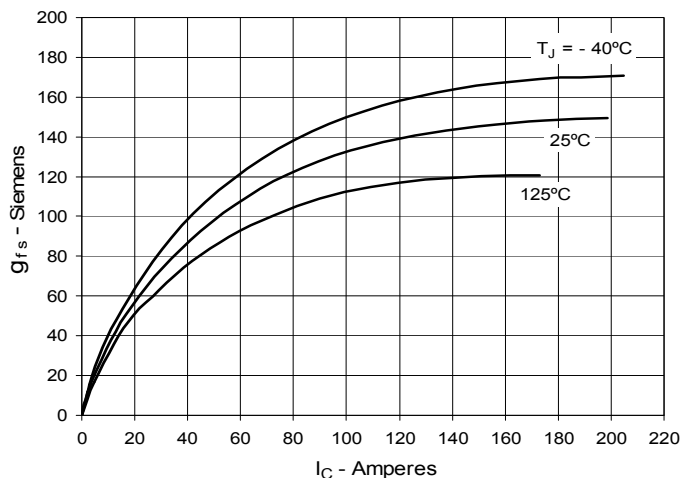

Fig. 8. Gate Charge

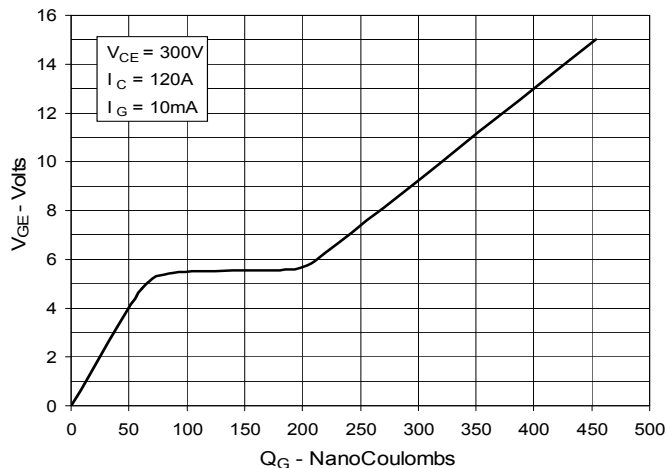

Fig. 9. Capacitance

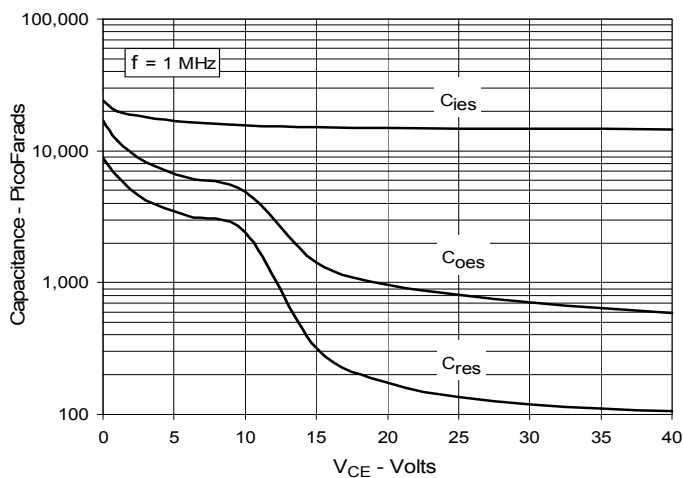

Fig. 10. Reverse-Bias Safe Operating Area

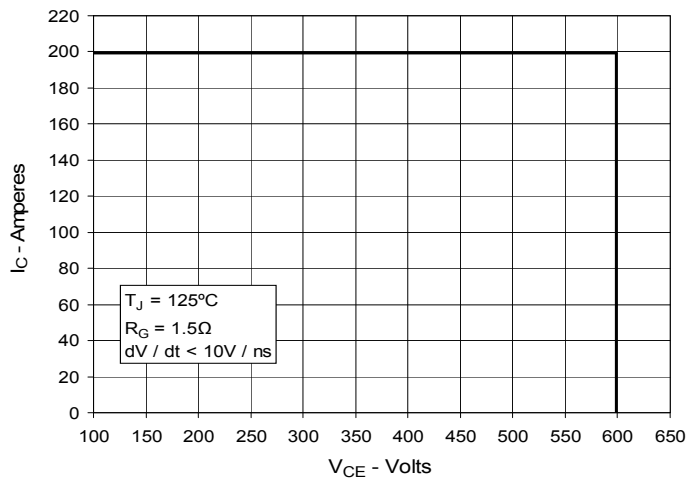

Fig. 11. Maximum Transient Thermal Impedance

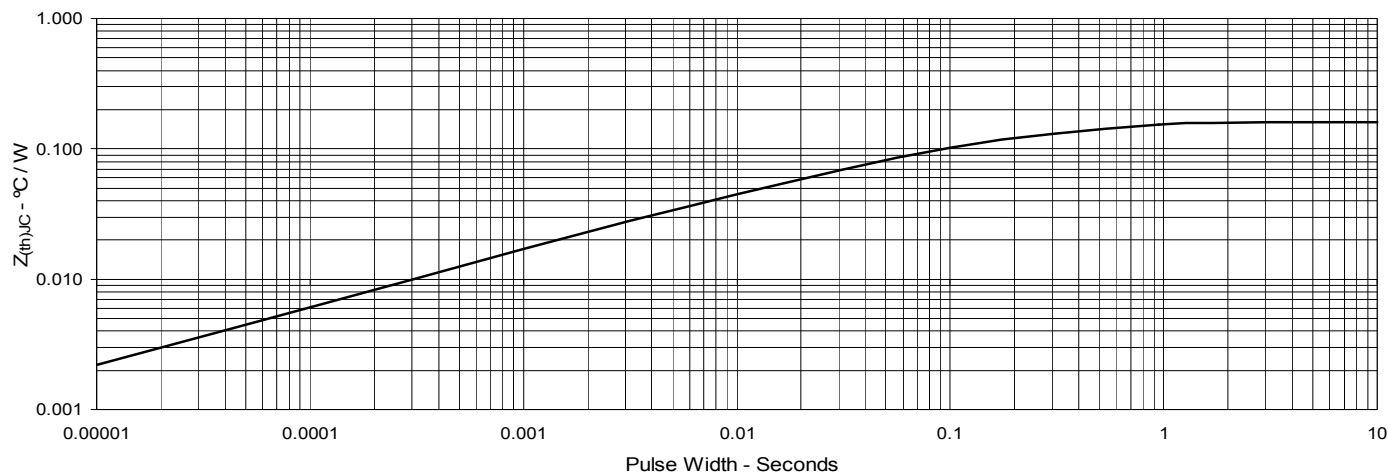

Fig. 12. Inductive Switching Energy Loss vs. Gate Resistance



Fig. 13. Inductive Switching Energy Loss vs. Collector Current

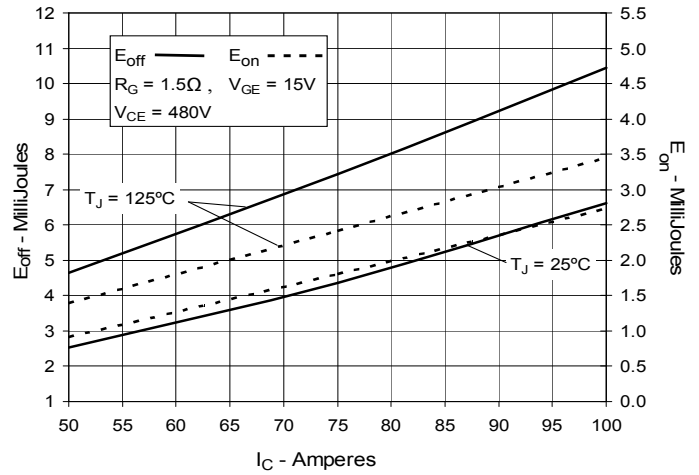

Fig. 14. Inductive Switching Energy Loss vs. Junction Temperature



Fig. 15. Inductive Turn-off Switching Times vs. Gate Resistance

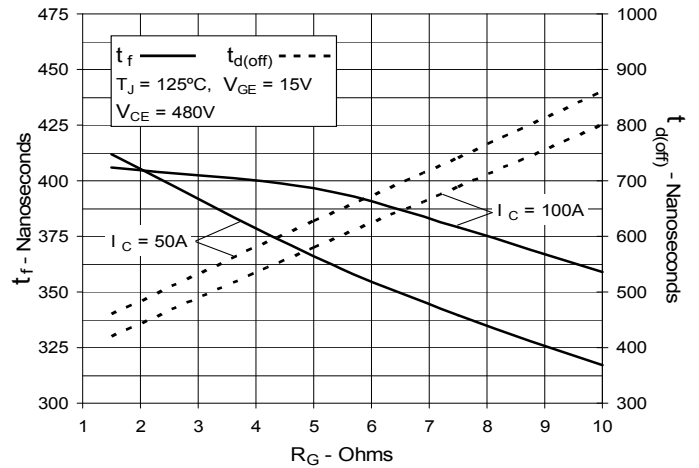

Fig. 16. Inductive Turn-off Switching Times vs. Collector Current

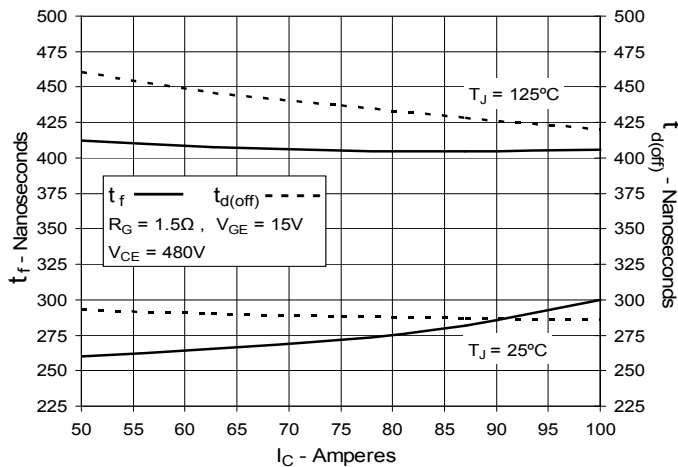
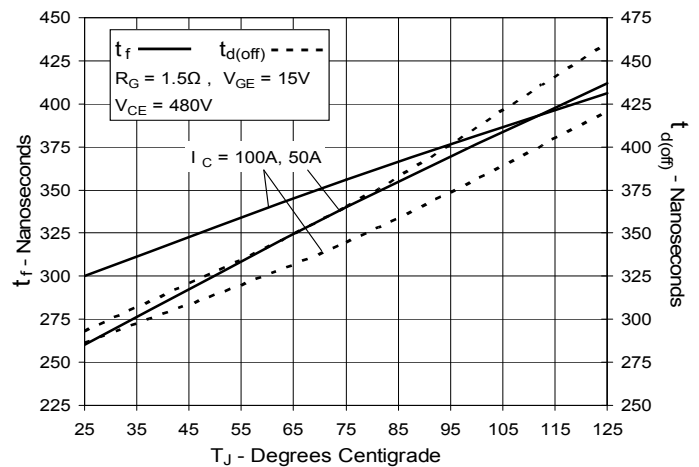
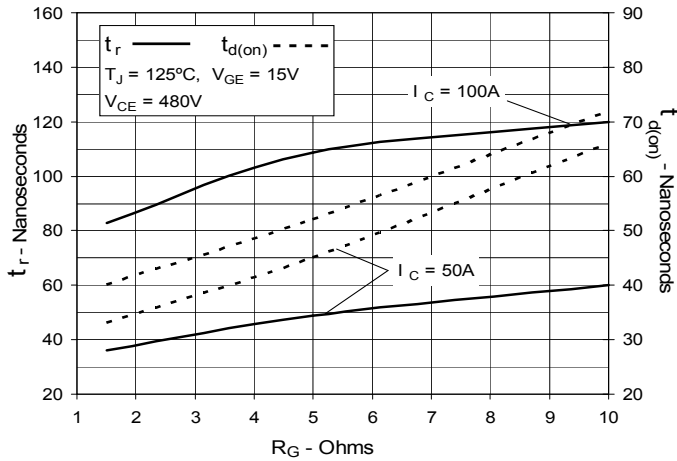

Fig. 17. Inductive Turn-off Switching Times vs. Junction Temperature



**Fig. 18. Inductive Turn-on
Switching Times vs. Gate Resistance**



**Fig. 19. Inductive Turn-on
Switching Times vs. Collector Current**

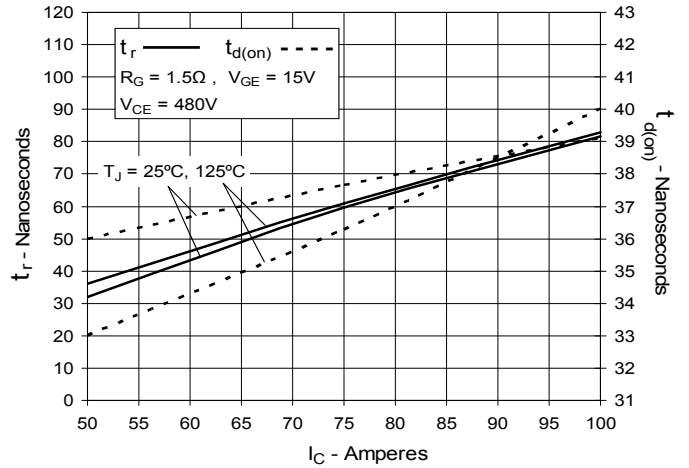

**Fig. 20. Inductive Turn-on
Switching Times vs. Junction Temperature**

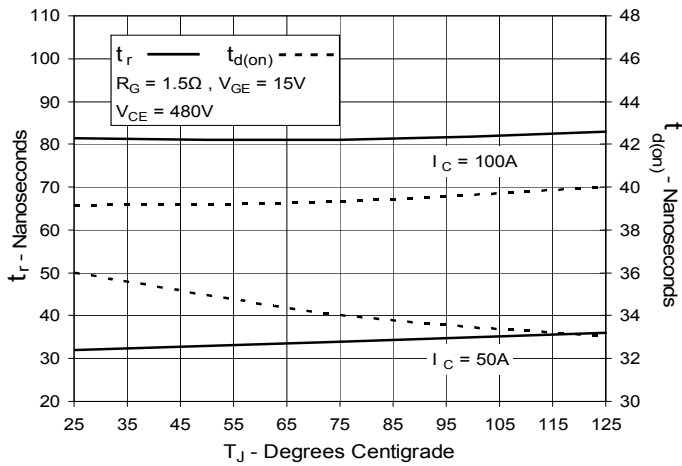



Disclaimer Notice - Information furnished is believed to be accurate and reliable. However, users should independently evaluate the suitability of and test each product selected for their own applications. Littelfuse products are not designed for, and may not be used in, all applications. Read complete Disclaimer Notice at www.littelfuse.com/disclaimer-electronics.