

# High Voltage IGBT

# IXGF32N170

( Electrically Isolated Tab )

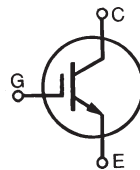

$V_{CES} = 1700V$   
 $I_{C110} = 19A$   
 $V_{CE(sat)} \leq 3.5V$   
 $t_{fi(typ)} = 250ns$

ISOPLUS i4-Pak™

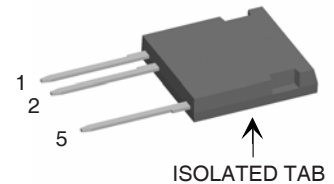

1 = Gate  
2 = Emitter  
5 = Collector

Symbol	Test Conditions	Maximum Ratings	
$V_{CES}$	$T_J = 25^\circ C$ to $150^\circ C$	1700	V
$V_{GES}$	Continuous	$\pm 20$	V
$V_{GEM}$	Transient	$\pm 30$	V
$I_{C25}$	$T_C = 25^\circ C$	44	A
$I_{C110}$	$T_C = 110^\circ C$	19	A
$I_{CM}$	$T_C = 25^\circ C$ , 1ms	200	A
<b>SSOA</b>	$V_{GE} = 15V$ , $T_{VJ} = 125^\circ C$ , $R_G = 2.7\Omega$	$I_{CM} = 70$	A
<b>(RBSOA)</b>	Clamped Inductive Load	@ $0.8 \cdot V_{CES}$	
$t_{sc}$	$T_C = 125^\circ C$ , $V_{CE} = 1200V$ , $V_{GE} = 15V$ , $R_G = 10\Omega$	10	$\mu s$
$P_C$	$T_C = 25^\circ C$	200	W
$T_J$		-55 ... +150	$^\circ C$
$T_{JM}$		150	$^\circ C$
$T_{stg}$		-55 ... +150	$^\circ C$
$T_L$	1.6 mm (0.062 in.) from Case for 10s	300	$^\circ C$
$T_{SOLD}$	Plastic Body for 10s	260	$^\circ C$
$F_C$	Mounting Force	20..120 / 4.5..27	Nm/lb.in.
$V_{ISOL}$	50/60Hz, 1 minute	2500	V~
<b>Weight</b>		5	g

## Features

- Electrically Isolated Tab
- High Current Handling Capability
- Rugged NPT Structure
- Molding Epoxies Meet UL 94 V-0 Flammability Classification

## Applications

- Capacitor Discharge & Pulser Circuits
- AC Motor Drives
- Uninterruptible Power Supplies (UPS)
- Switched-Mode and Resonant-Mode Power Supplies

## Advantages

- High Power Density
- Suitable for Surface Mounting

Symbol	Test Conditions ( $T_J = 25^\circ C$ , Unless Otherwise Specified)	Characteristic Values		
		Min.	Typ.	Max.
$BV_{CES}$	$I_C = 1mA$ , $V_{GE} = 0V$	1700		V
$V_{GE(th)}$	$I_C = 250\mu A$ , $V_{CE} = V_{GE}$	3.0		5.0 V
$I_{CES}$	$V_{CE} = 0.8 \cdot V_{CES}$ , $V_{GE} = 0V$ , Note 2 $T_J = 125^\circ C$			50 $\mu A$ 1 mA
$I_{GES}$	$V_{CE} = 0V$ , $V_{GE} = \pm 20V$			$\pm 100$ nA
$V_{CE(sat)}$	$I_C = 32A$ , $V_{GE} = 15V$ , Note 1 $T_J = 125^\circ C$	2.7 3.3	3.5	V V

Symbol	Test Conditions ( $T_J = 25^\circ\text{C}$ , Unless Otherwise Specified)	Characteristic Values		
		Min.	Typ.	Max.
$g_{fs}$	$I_C = 32\text{A}$ , $V_{CE} = 10\text{V}$ , Note 1	20	30	S
$C_{ies}$	$V_{CE} = 25\text{V}$ , $V_{GE} = 0\text{V}$ , $f = 1\text{MHz}$		4290	pF
$C_{oes}$			167	pF
$C_{res}$			47	pF
$Q_g$	$I_C = 32\text{A}$ , $V_{GE} = 15\text{V}$ , $V_{CE} = 0.5 \cdot V_{CES}$		146	nC
$Q_{ge}$			28	nC
$Q_{gc}$			52	nC
$t_{d(on)}$	<b>Inductive load, <math>T_J = 25^\circ\text{C}</math></b> $I_C = 32\text{A}$ , $V_{GE} = 15\text{V}$ $V_{CE} = 0.6 \cdot V_{CES}$ , $R_G = 2.7\Omega$		45	ns
$t_{ri}$			38	ns
$t_{d(off)}$			270	500 ns
$t_{fi}$			250	500 ns
$E_{off}$			10.6	20 mJ
$t_{d(on)}$	<b>Inductive load, <math>T_J = 125^\circ\text{C}</math></b> $I_C = 32\text{A}$ , $V_{GE} = 15\text{V}$ $V_{CE} = 0.6 \cdot V_{CES}$ , $R_G = 2.7\Omega$		48	ns
$t_{ri}$			42	ns
$E_{off}$			6.0	mJ
$t_{d(off)}$			360	ns
$t_{fi}$			560	ns
$E_{off}$		13.5	mJ	
$R_{thJC}$				0.62 °C/W
$R_{thCS}$		0.15		°C/W
$R_{thJA}$		30		°C/W

### ISOPLUS i4-Pak™ (HV) (IXGF) Outline

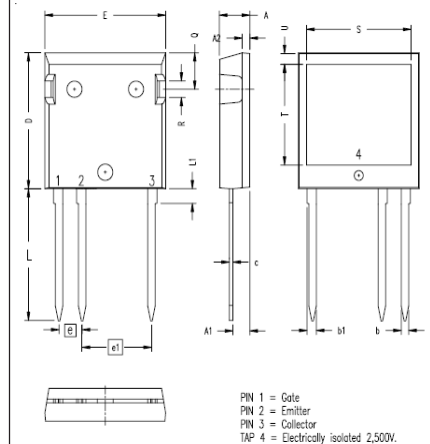

SYM	INCHES		MILLIMETERS	
	MIN	MAX	MIN	MAX
A	.190	.205	4.83	5.21
A1	.102	.118	2.59	3.00
A2	.046	.085	1.17	2.16
b	.045	.055	1.14	1.40
b1	.058	.068	1.47	1.73
C	.020	.029	0.51	0.74
D	.819	.840	20.80	21.34
E	.770	.799	19.56	20.29
e	.150 BSC		3.81 BSC	
e1	.450 BSC		11.43 BSC	
L	.780	.840	19.81	21.34
L1	.083	.102	2.11	2.59
Q	.210	.244	5.33	6.20
R	.100	.180	2.54	4.57
S	.660	.690	16.76	17.53
T	.590	.620	14.99	15.75
U	.065	.080	1.65	2.03

- Notes: 1. Pulse test,  $t < 300\mu\text{s}$ ; duty cycle,  $d < 2\%$ .  
 2. Device must be heatsunk for high temperature leakage current measurements to avoid thermal runaway.

IXYS Reserves the Right to Change Limits, Test Conditions, and Dimensions.

IXYS MOSFETs and IGBTs are covered by one or more of the following U.S. patents:	4,835,592	4,931,844	5,049,961	5,237,481	6,162,665	6,404,065 B1	6,683,344	6,727,585	7,005,734 B2	7,157,338B2
	4,850,072	5,017,508	5,063,307	5,381,025	6,259,123 B1	6,534,343	6,710,405 B2	6,759,692	7,063,975 B2	
	4,881,106	5,034,796	5,187,117	5,486,715	6,306,728 B1	6,583,505	6,710,463	6,771,478 B2	7,071,537	

**Fig. 1. Output Characteristics @ 25°C**

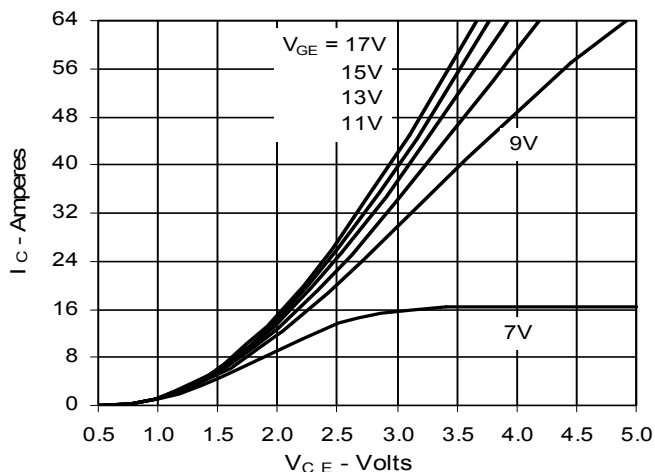

**Fig. 2. Extended Output Characteristics @ 25°C**

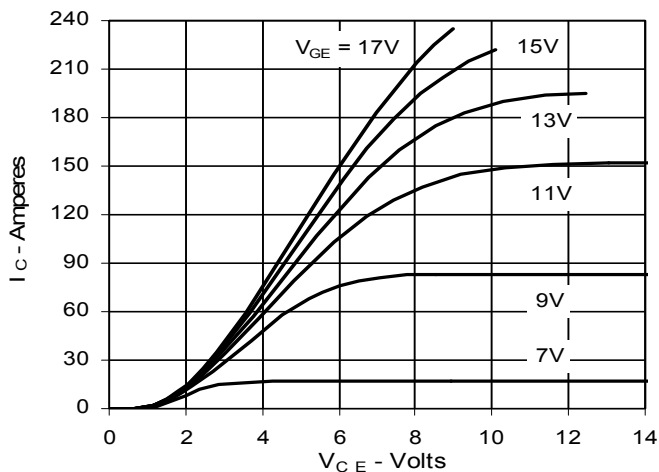

**Fig. 3. Output Characteristics @ 125°C**

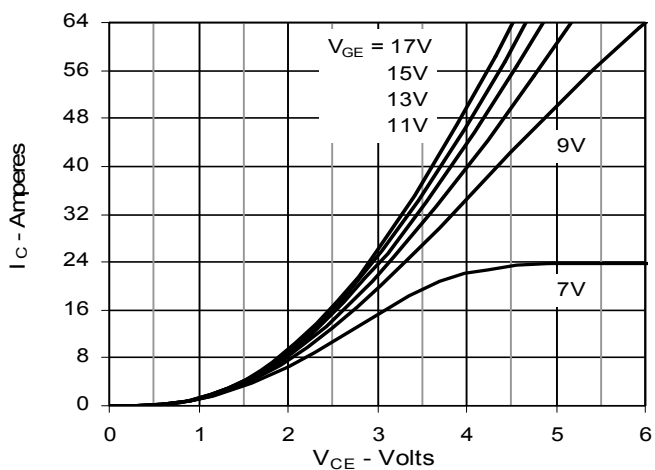

**Fig. 4. Dependence of  $V_{CE(sat)}$  on Temperature**

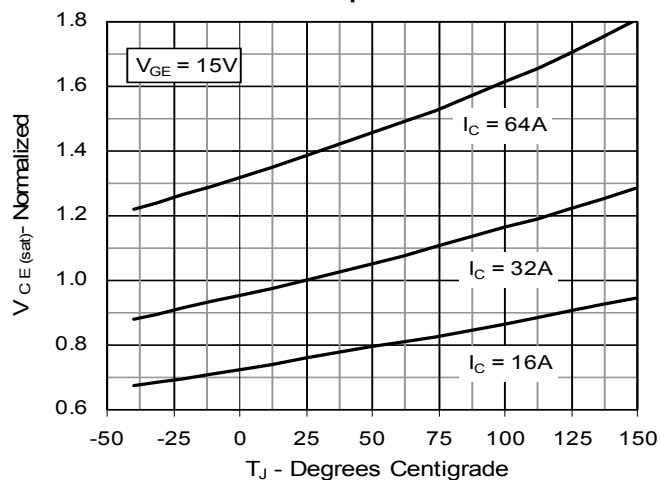

**Fig. 5. Collector-to-Emitter Voltage vs. Gate-to-Emitter voltage**

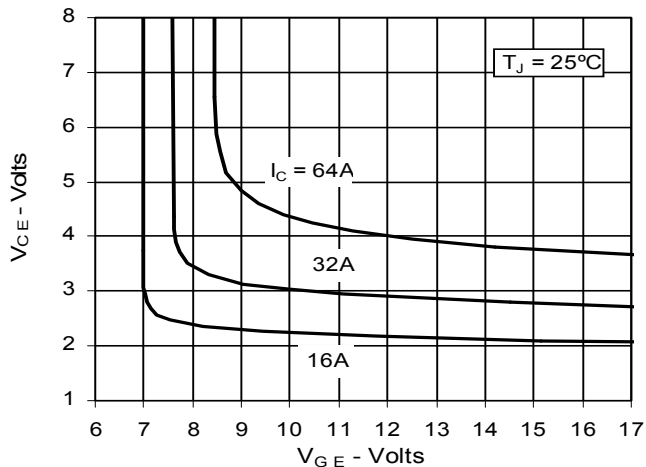

**Fig. 6. Input Admittance**

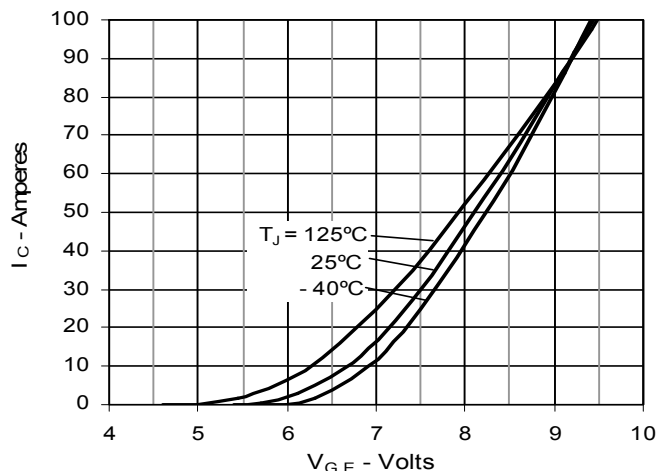

**Fig. 7. Transconductance**

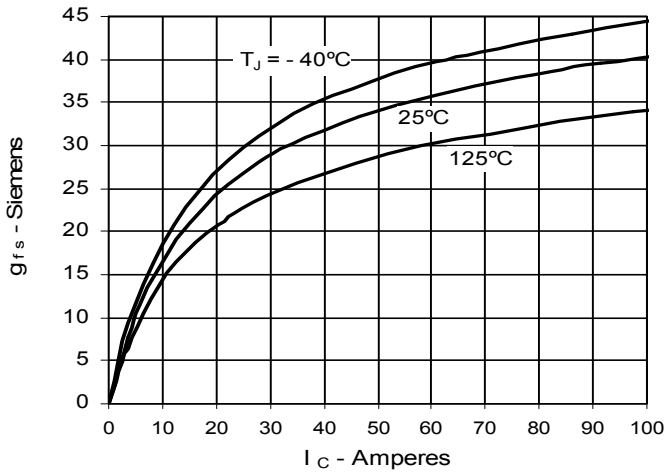

**Fig. 8. Gate Charge**

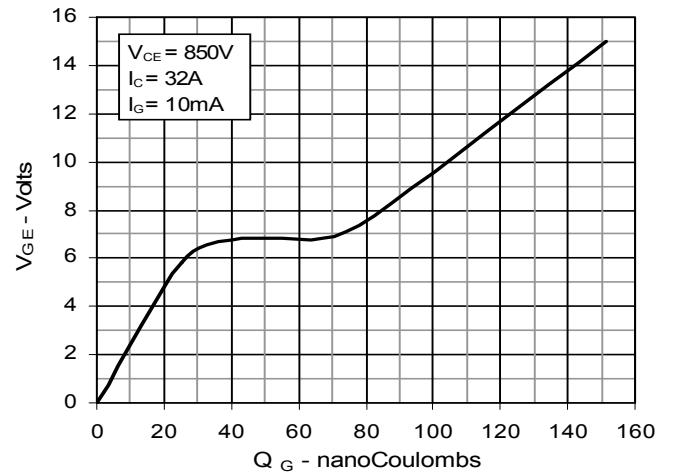

**Fig. 9. Capacitance**

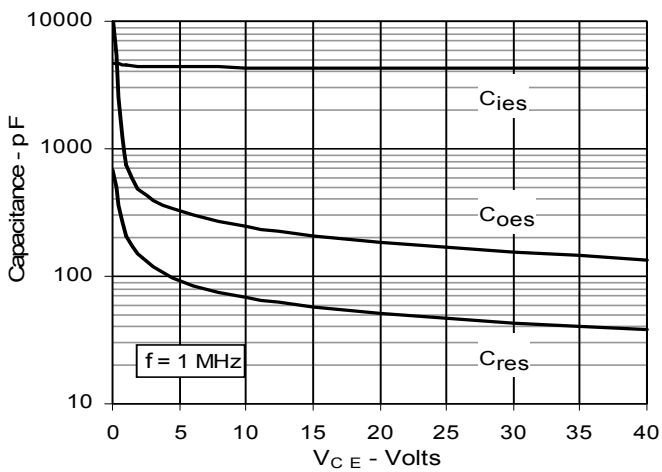

**Fig. 10. Dependence of  $E_{off}$  on  $R_G$**

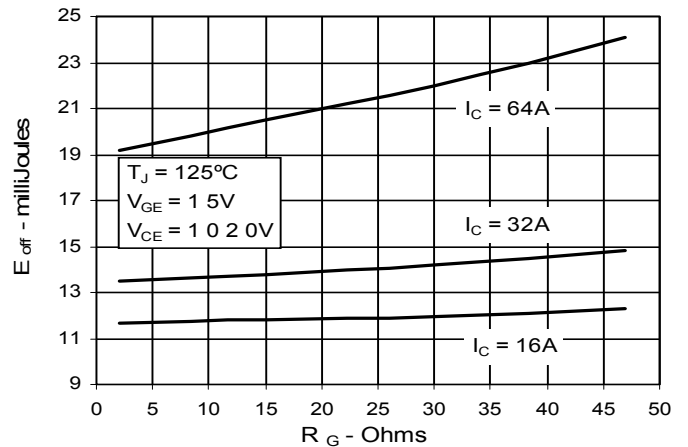

**Fig. 11. Dependence of  $E_{off}$  on  $I_C$**

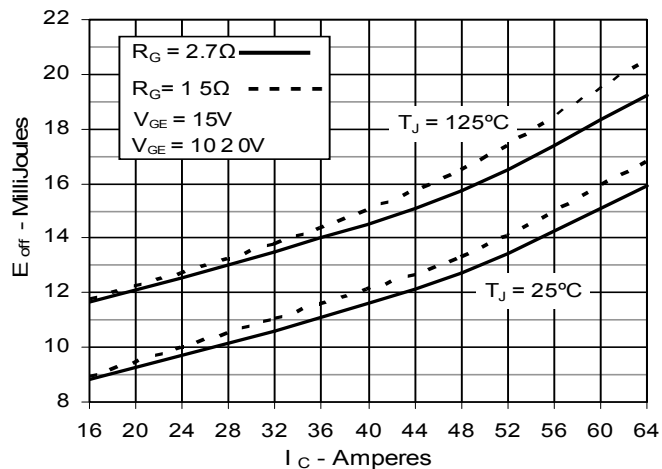

**Fig. 12. Dependence of  $E_{off}$  on Temperature**

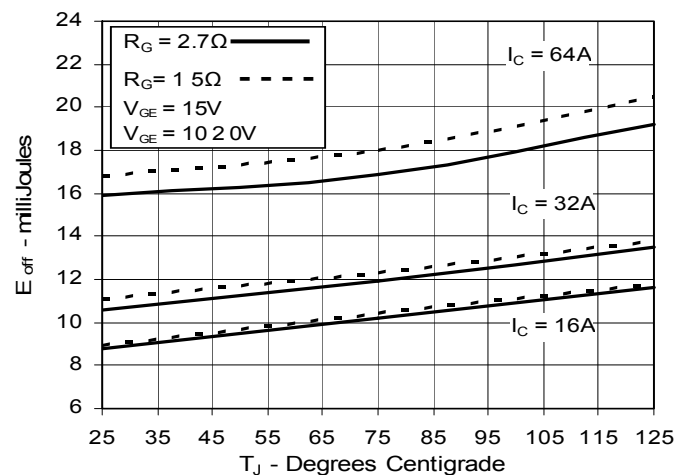
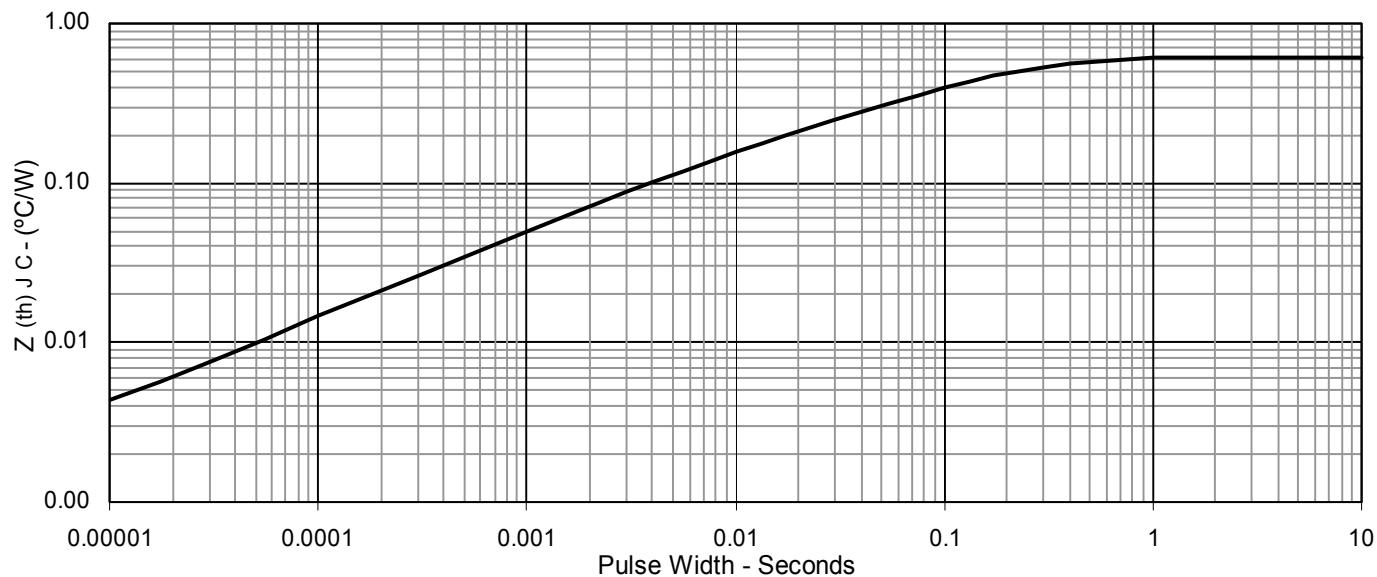

Fig. 13. Maximum Transient Thermal Impedance





---

Disclaimer Notice - Information furnished is believed to be accurate and reliable. However, users should independently evaluate the suitability of and test each product selected for their own applications. Littelfuse products are not designed for, and may not be used in, all applications. Read complete Disclaimer Notice at [www.littelfuse.com/disclaimer-electronics](http://www.littelfuse.com/disclaimer-electronics).