

# High Voltage IGBT

**IXGH 32N170**  
**IXGT 32N170**

**V<sub>CES</sub> = 1700 V**  
**I<sub>C25</sub> = 75 A**  
**V<sub>CE(sat)</sub> = 3.3 V**  
**t<sub>fi(typ)</sub> = 250 ns**

## Preliminary Data Sheet

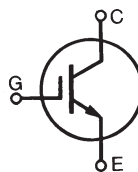

Symbol	Test Conditions	Maximum Ratings	
V <sub>CES</sub>	T <sub>J</sub> = 25°C to 150°C	1700	V
V <sub>CGR</sub>	T <sub>J</sub> = 25°C to 150°C; R <sub>GE</sub> = 1 MΩ	1700	V
V <sub>GES</sub>	Continuous	±20	V
V <sub>GEM</sub>	Transient	±30	V
I <sub>C25</sub>	T <sub>C</sub> = 25°C	75	A
I <sub>C90</sub>	T <sub>C</sub> = 90°C	32	A
I <sub>CM</sub>	T <sub>C</sub> = 25°C, 1 ms	200	A
<b>SSOA (RBSOA)</b>	V <sub>GE</sub> = 15 V, T <sub>VJ</sub> = 125°C, R <sub>G</sub> = 5 Ω Clamped inductive load	I <sub>CM</sub> = 90 @ 0.8 V <sub>CES</sub>	A
P <sub>C</sub>	T <sub>C</sub> = 25°C	350	W
T <sub>J</sub>		-55 ... +150	°C
T <sub>JM</sub>		150	°C
T <sub>stg</sub>		-55 ... +150	°C
Maximum Lead temperature for soldering 1.6 mm (0.062 in.) from case for 10 s		300	°C
Maximum Tab temperature for soldering SMD devices for 10 s		260	°C
M <sub>d</sub>	Mounting torque (M3)	1.13/10Nm/lb.in.	
<b>Weight</b>		TO-247 AD	6 g
		TO-268	4 g

### TO-268 (IXGT)

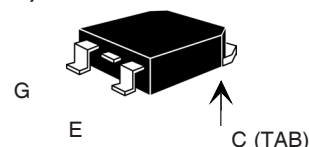

### TO-247 AD (IXGH)

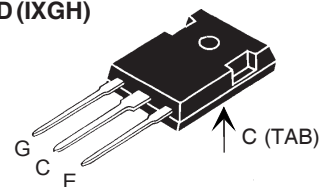

G = Gate, C = Collector,  
E = Emitter, TAB = Collector

### Features

- International standard packages JEDEC TO-268 and JEDEC TO-247 AD
- High current handling capability
- MOS Gate turn-on - drive simplicity
- Rugged NPT structure
- Molding epoxies meet UL 94 V-0 flammability classification

### Applications

- Capacitor discharge & pulser circuits
- AC motor speed control
- DC servo and robot drives
- DC choppers
- Uninterruptible power supplies (UPS)
- Switched-mode and resonant-mode power supplies

### Advantages

- High power density
- Suitable for surface mounting
- Easy to mount with 1 screw, (isolated mounting screw hole)

Symbol	Test Conditions	Characteristic Values (T <sub>J</sub> = 25°C, unless otherwise specified)		
		min.	typ.	max.
<b>BV<sub>CES</sub></b>	I <sub>C</sub> = 250 μA, V <sub>GE</sub> = 0 V	1700		V
<b>V<sub>GE(th)</sub></b>	I <sub>C</sub> = 250 μA, V <sub>CE</sub> = V <sub>GE</sub>	3.0		V
<b>I<sub>CES</sub></b>	V <sub>CE</sub> = 0.8 • V <sub>CES</sub> V <sub>GE</sub> = 0 V			50 μA 1 mA
<b>I<sub>GES</sub></b>	V <sub>CE</sub> = 0 V, V <sub>GE</sub> = ±20 V			±100 nA
<b>V<sub>CE(sat)</sub></b>	I <sub>C</sub> = I <sub>C90</sub> , V <sub>GE</sub> = 15 V			2.5 V 3.0 V

Symbol	Test Conditions	Characteristic Values ( $T_J = 25^\circ\text{C}$ , unless otherwise specified)		
		min.	typ.	max.
$g_{fs}$	$I_C = I_{C90}$ ; $V_{CE} = 10\text{ V}$ , Pulse test, $t \leq 300\ \mu\text{s}$ , duty cycle $\leq 2\%$	22	30	S
$I_{C(ON)}$	$V_{GE} = 10\text{ V}$ , $V_{CE} = 10\text{ V}$		120	A
$C_{ies}$	$V_{CE} = 25\text{ V}$ , $V_{GE} = 0\text{ V}$ , $f = 1\text{ MHz}$		3500	pF
$C_{oes}$			165	pF
$C_{res}$			40	pF
$Q_g$	$I_C = I_{C90}$ , $V_{GE} = 15\text{ V}$ , $V_{CE} = 0.5 V_{CES}$		155	nC
$Q_{ge}$			30	nC
$Q_{gc}$			51	nC
$t_{d(on)}$	<b>Inductive load, <math>T_J = 25^\circ\text{C}</math></b> $I_C = I_{C90}$ , $V_{GE} = 15\text{ V}$ $V_{CE} = 0.6 V_{CES}$ , $R_G = R_{off} = 2.7\ \Omega$		45	ns
$t_{ri}$			38	ns
$t_{d(off)}$			270	500 ns
$t_{fi}$			250	500 ns
$E_{off}$			11	20 mJ
$t_{d(on)}$	<b>Inductive load, <math>T_J = 125^\circ\text{C}</math></b> $I_C = I_{C90}$ , $V_{GE} = 15\text{ V}$ $V_{CE} = 0.6 V_{CES}$ , $R_G = R_{off} = 2.7\ \Omega$		48	ns
$t_{ri}$			42	ns
$E_{on}$			6.0	mJ
$t_{d(off)}$			360	ns
$t_{fi}$			560	ns
$E_{off}$			14	mJ
$R_{thJC}$			0.35	K/W
$R_{thCK}$	(TO-247)	0.25		K/W

### Min Recommended Footprint

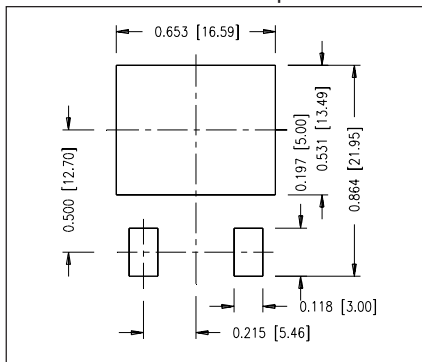

### TO-247 AD Outline

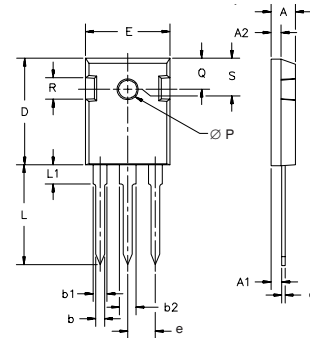

Dim.	Millimeter		Inches	
	Min.	Max.	Min.	Max.
A	4.7	5.3	.185	.209
A <sub>1</sub>	2.2	2.54	.087	.102
A <sub>2</sub>	2.2	2.6	.059	.098
b	1.0	1.4	.040	.055
b <sub>1</sub>	1.65	2.13	.065	.084
b <sub>2</sub>	2.87	3.12	.113	.123
C	.4	.8	.016	.031
D	20.80	21.46	.819	.845
E	15.75	16.26	.610	.640
e	5.20	5.72	0.205	0.225
L	19.81	20.32	.780	.800
L1		4.50		.177
∅P	3.55	3.65	.140	.144
Q	5.89	6.40	0.232	0.252
R	4.32	5.49	.170	.216
S	6.15	BSC	.242	BSC

### TO-268 Outline

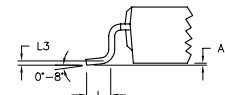
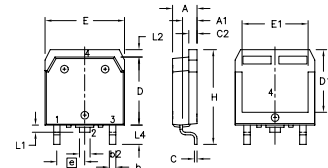

Dim.	Millimeter		Inches	
	Min.	Max.	Min.	Max.
A	4.9	5.1	.193	.201
A <sub>1</sub>	2.7	2.9	.106	.114
A <sub>2</sub>	.02	.25	.001	.010
b	1.15	1.45	.045	.057
b <sub>2</sub>	1.9	2.1	.75	.83
C	.4	.65	.016	.026
D	13.80	14.00	.543	.551
E	15.85	16.05	.624	.632
E <sub>1</sub>	13.3	13.6	.524	.535
e	5.45	BSC	.215	BSC
H	18.70	19.10	.736	.752
L	2.40	2.70	.094	.106
L1	1.20	1.40	.047	.055
L2	1.00	1.15	.039	.045
L3		0.25		.010
L4	3.80	4.10	.150	.161

IXYS reserves the right to change limits, test conditions, and dimensions.

IXYS MOSFETs and IGBTs are covered by one or more of the following U.S. patents:

4,835,592 4,881,106 5,017,508 5,049,961 5,187,117 5,486,715 6,306,728B1 6,259,123B1 6,306,728B1  
4,850,072 4,931,844 5,034,796 5,063,307 5,237,481 5,381,025 6,404,065B1 6,162,665 6,534,343 6,583,505

**Fig. 1. Output Characteristics @ 25 Deg. C**

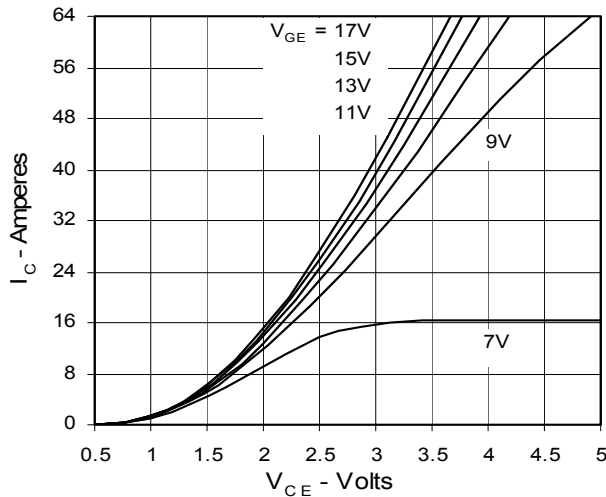

**Fig. 2. Extended Output Characteristics @ 25 deg. C**

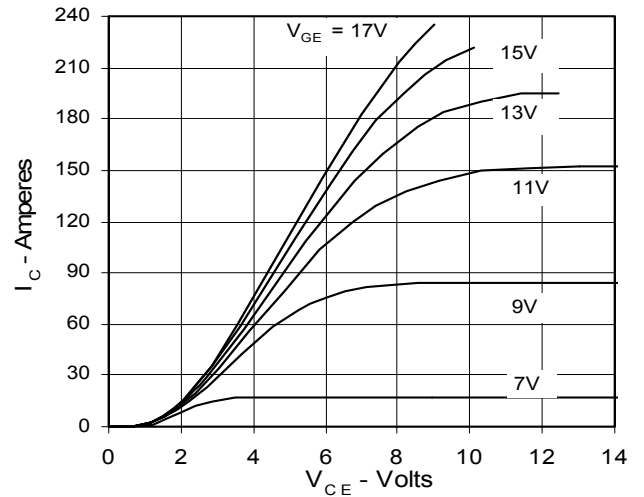

**Fig. 3. Output Characteristics @ 125 Deg. C**

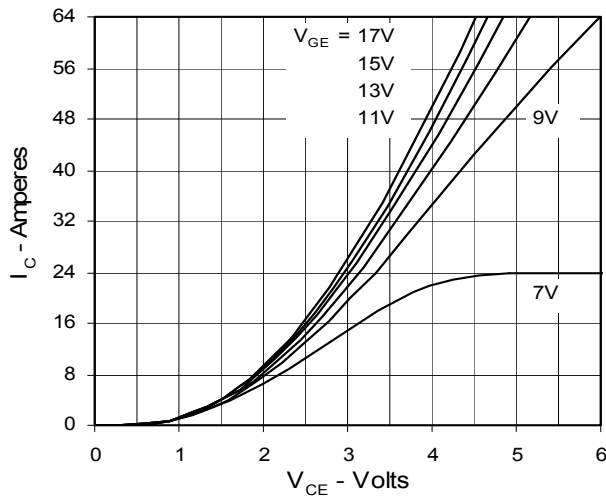

**Fig. 4. Dependence of V<sub>CE(sat)</sub> on Temperature**

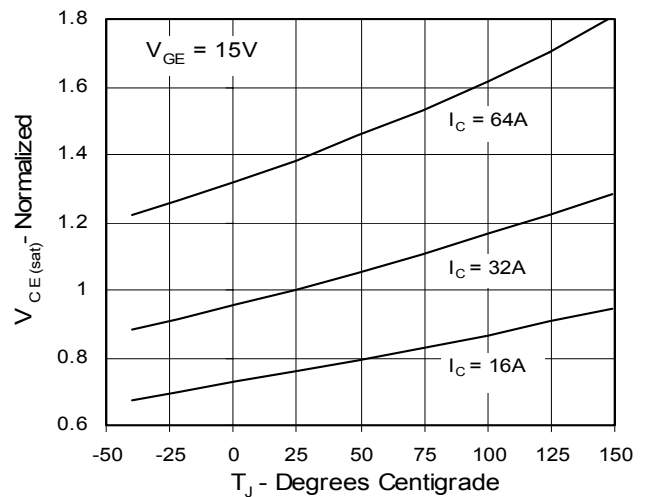

**Fig. 5. Collector-to-Emitter Voltage vs. Gate-to-Emitter voltage**

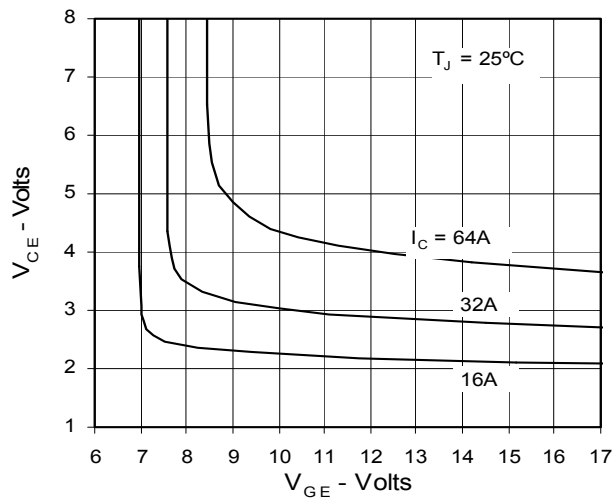

**Fig. 6. Input Admittance**

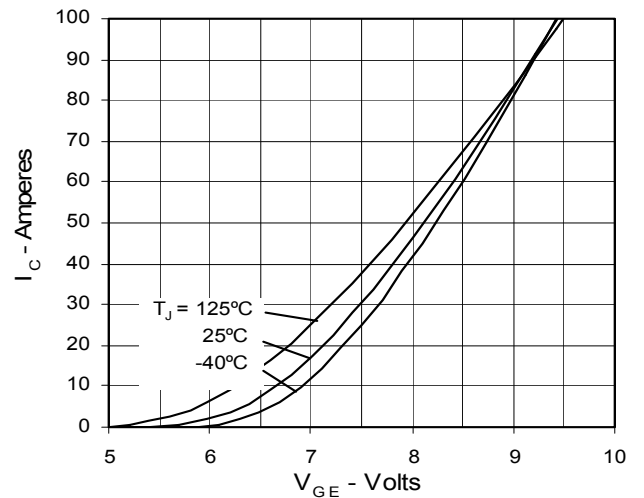

Fig. 7. Transconductance

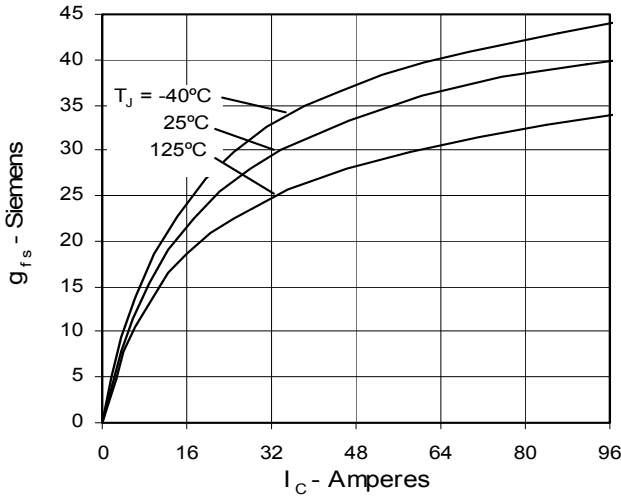

Fig. 8. Dependence of  $E_{off}$  on  $R_G$

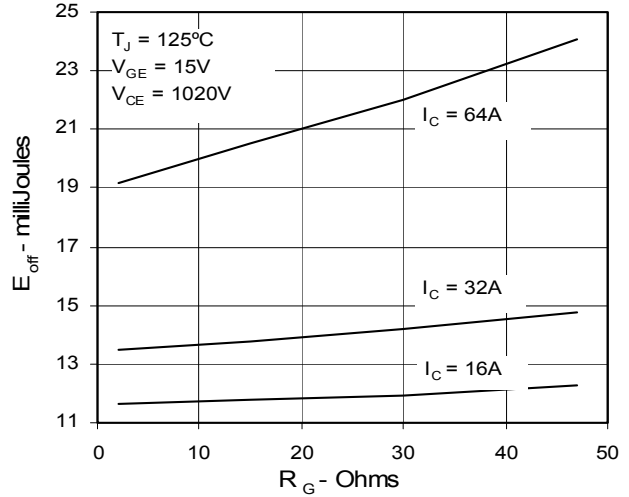

Fig. 9. Dependence of  $E_{off}$  on  $I_C$

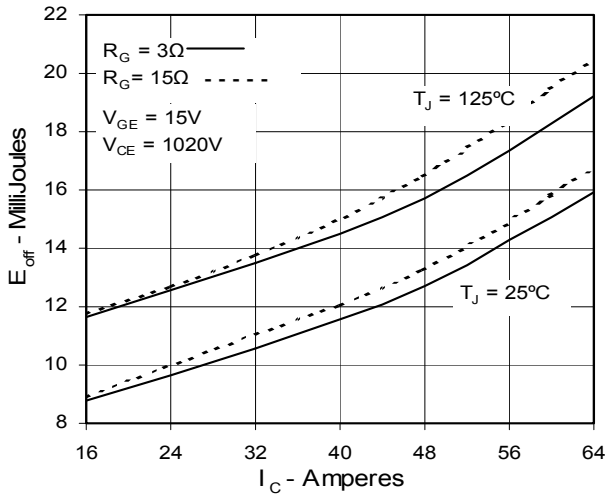

Fig. 10. Dependence of  $E_{off}$  on Temperature

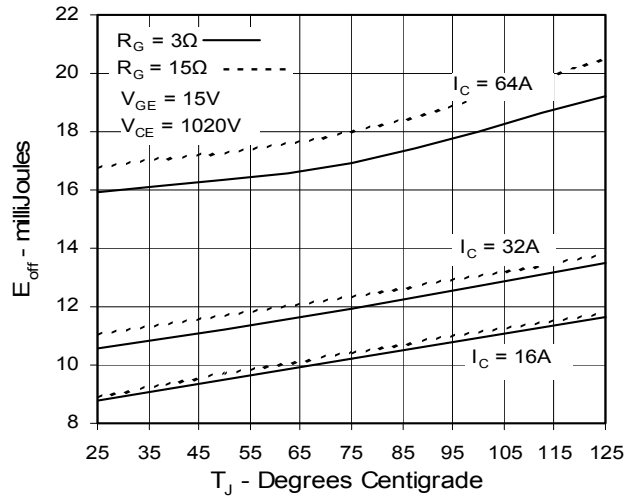

Fig. 11. Gate Charge

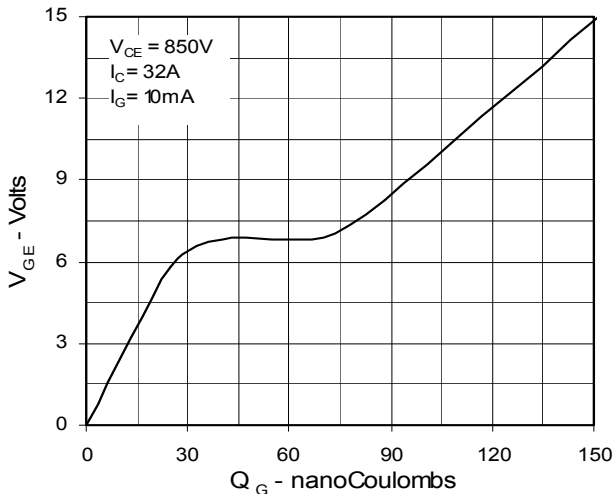
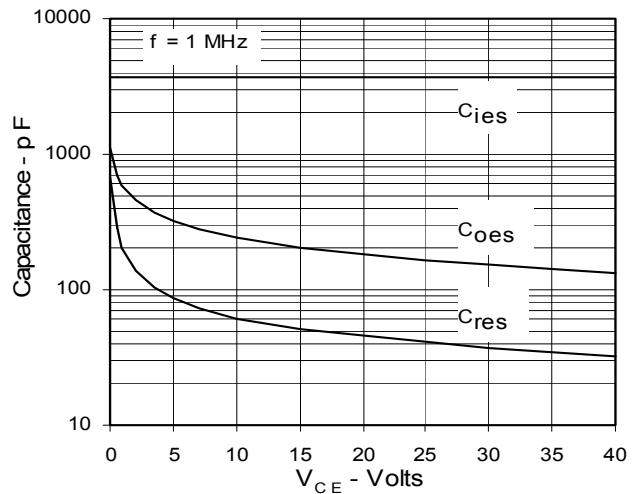

Fig. 12. Capacitance



IXYS reserves the right to change limits, test conditions, and dimensions.

IXYS MOSFETs and IGBTs are covered by one or more of the following U.S. patents: 4,835,592 4,881,106 5,017,508 5,049,961 5,187,117 5,486,715 6,306,728B1 6,259,123B1 6,306,728B1 4,850,072 4,931,844 5,034,796 5,063,307 5,237,481 5,381,025 6,404,065B1 6,162,665 6,534,343 6,583,505

Fig. 13. Maximum Transient Thermal Resistance

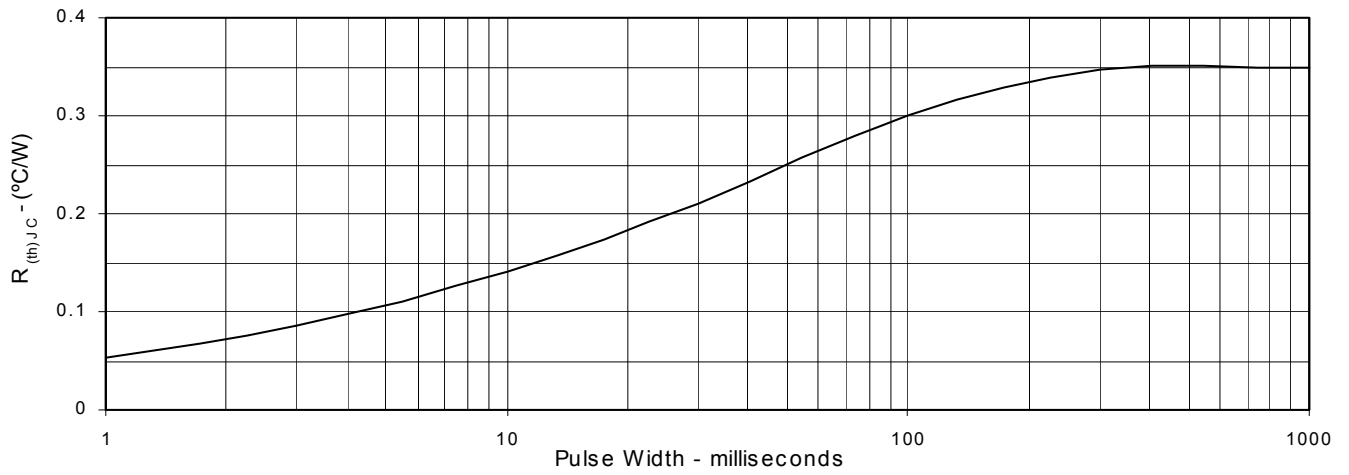



---

Disclaimer Notice - Information furnished is believed to be accurate and reliable. However, users should independently evaluate the suitability of and test each product selected for their own applications. Littelfuse products are not designed for, and may not be used in, all applications. Read complete Disclaimer Notice at [www.littelfuse.com/disclaimer-electronics](http://www.littelfuse.com/disclaimer-electronics).