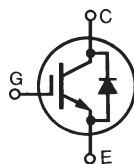

**High Voltage  
IGBTs w/Diode**
**IXGH24N170AH1  
IXGT24N170AH1**

$$V_{CES} = 1700V$$

$$I_{C25} = 24A$$

$$V_{CE(sat)} \leq 6.0V$$

$$t_{fi(typ)} = 40ns$$

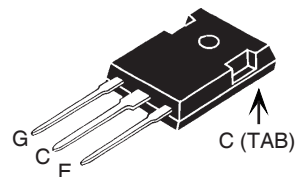
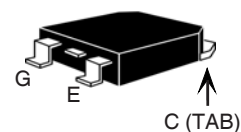
**TO-247 (IXGH)**

**TO-268 (IXGT)**

G = Gate      C = Collector  
E = Emitter    TAB = Collector

Symbol	Test Conditions	Maximum Ratings	
$V_{CES}$	$T_C = 25^\circ C$ to $150^\circ C$	1700	V
$V_{CGR}$	$T_J = 25^\circ C$ to $150^\circ C$ , $R_{GE} = 1M\Omega$	1700	V
$V_{GES}$	Continuous	$\pm 20$	V
$V_{GEM}$	Transient	$\pm 30$	V
$I_{C25}$	$T_C = 25^\circ C$	24	A
$I_{C90}$	$T_C = 90^\circ C$	16	A
$I_{CM}$	$T_C = 25^\circ C$ , 1ms	75	A
<b>SSOA (RBSOA)</b>	$V_{GE} = 15V$ , $T_{VJ} = 125^\circ C$ , $R_G = 10\Omega$ Clamped Inductive Load	$I_{CM} = 50$ $0.8 \cdot V_{CES}$	A V
$t_{sc}$	$T_J = 125^\circ C$ , $V_{CE} = 1200V$ , $V_{GE} = 15V$ , $R_G = 22\Omega$	10	$\mu s$
$P_C$	$T_C = 25^\circ C$	250	W
$T_J$		-55 ... +150	$^\circ C$
$T_{JM}$		150	$^\circ C$
$T_{stg}$		-55 ... +150	$^\circ C$
$T_L$	1.6mm (0.062 in.) from Case for 10s	300	$^\circ C$
$T_{SOLD}$	Plastic Body for 10 seconds	260	$^\circ C$
$M_d$	Mounting Torque (TO-247)	1.13/10	Nm/lb.in.
<b>Weight</b>	TO-247	6	g
	TO-268	4	g

**Features**

- Optimized for Low Conduction and Switching Losses
- Anti-Parallel Ultra Fast Diode
- International Standard Packages

**Advantages**

- High Power Density
- Low Gate Drive Requirement

**Applications**

- Power Inverters
- UPS
- Motor Drives
- SMPS
- PFC Circuits
- Welding Machines

Symbol	Test Conditions ( $T_J = 25^\circ C$ Unless Otherwise Specified)	Characteristic Values		
		Min.	Typ.	Max.
$BV_{CES}$	$I_C = 250\mu A$ , $V_{GE} = 0V$	1700		V
$V_{GE(th)}$	$I_C = 250\mu A$ , $V_{CE} = V_{GE}$	3.0		V
$I_{CES}$	$V_{CE} = 0.8 \cdot V_{CES}$ , $V_{GE} = 0V$ $T_J = 125^\circ C$			100 $\mu A$ 1.5 mA
$I_{GES}$	$V_{CE} = 0V$ , $V_{GE} = \pm 20V$			$\pm 100$ nA
$V_{CE(sat)}$	$I_C = 16A$ , $V_{GE} = 15V$ , Note 1 $T_J = 125^\circ C$		4.5 4.8	6.0 V V

Symbol	Test Conditions ( $T_J = 25^\circ\text{C}$ , Unless Otherwise Specified)	Characteristic Values		
		Min.	Typ.	Max.
$g_{fs}$	$I_C = 24\text{A}$ , $V_{CE} = 10\text{V}$ , Note 2	13	22	S
$C_{ies}$	$V_{CE} = 25\text{V}$ , $V_{GE} = 0\text{V}$ , $f = 1\text{MHz}$		2860	pF
$C_{oes}$			198	pF
$C_{res}$			58	pF
$Q_g$	$I_C = 16\text{A}$ , $V_{GE} = 15\text{V}$ , $V_{CE} = 0.5 \cdot V_{CES}$		140	nC
$Q_{ge}$			18	nC
$Q_{gc}$			60	nC
$t_{d(on)}$	<b>Inductive Load, <math>T_J = 25^\circ\text{C}</math></b> $I_C = 24\text{A}$ , $V_{GE} = 15\text{V}$ $V_{CE} = 0.5 \cdot V_{CES}$ , $R_G = 10\Omega$ Note 1		21	ns
$t_{ri}$			36	ns
$E_{on}$			2.97	mJ
$t_{d(off)}$			336	ns
$t_{fi}$			40	80 ns
$E_{off}$			0.79	1.50 mJ
$t_{d(on)}$	<b>Inductive Load, <math>T_J = 125^\circ\text{C}</math></b> $I_C = 24\text{A}$ , $V_{GE} = 15\text{V}$ $V_{CE} = 0.5 \cdot V_{CES}$ , $R_G = 10\Omega$ Note 1		23	ns
$t_{ri}$			31	ns
$E_{on}$			3.60	mJ
$t_{d(off)}$			360	ns
$t_{fi}$			96	ns
$E_{off}$			1.47	mJ
$R_{thJC}$				0.50 $^\circ\text{C/W}$
$R_{thCK}$	(TO-247)	0.21		$^\circ\text{C/W}$

### TO-247 (IXGH) Outline

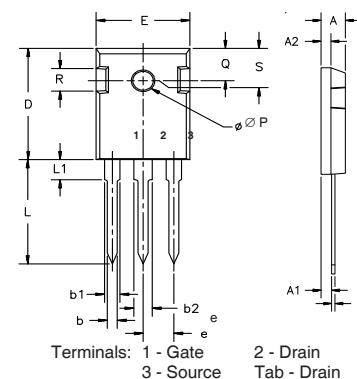

Dim.	Millimeter		Inches	
	Min.	Max.	Min.	Max.
A	4.7	5.3	.185	.209
A <sub>1</sub>	2.2	2.54	.087	.102
A <sub>2</sub>	2.2	2.6	.059	.098
b	1.0	1.4	.040	.055
b <sub>1</sub>	1.65	2.13	.065	.084
b <sub>2</sub>	2.87	3.12	.113	.123
C	.4	.8	.016	.031
D	20.80	21.46	.819	.845
E	15.75	16.26	.610	.640
e	5.20	5.72	0.205	0.225
L	19.81	20.32	.780	.800
L <sub>1</sub>		4.50		.177
∅P	3.55	3.65	.140	.144
Q	5.89	6.40	0.232	0.252
R	4.32	5.49	.170	.216
S	6.15	BSC	242	BSC

### Reverse Diode (FRED)

Symbol	Test Conditions ( $T_J = 25^\circ\text{C}$ , Unless Otherwise Specified)	Characteristic Values		
		Min.	Typ.	Max.
$V_F$	$I_F = 20\text{A}$ , $V_{GE} = 0\text{V}$ $T_J = 125^\circ\text{C}$		2.5	2.95 V
$I_{RM}$	$I_F = 20\text{A}$ , $-di_F/dt = 150\text{A}/\mu\text{s}$ , $V_R = 1200\text{V}$ , $V_{GE} = 0\text{V}$ $T_J = 125^\circ\text{C}$		15	A
$t_{rr}$			80	ns
$I_{RM}$			20	A
$t_{rr}$			200	ns
$R_{thJC}$				0.9 $^\circ\text{C/W}$

- Notes:
- Switching times may increase for  $V_{CE}(\text{Clamp}) > 0.5 \cdot V_{CES}$ , higher  $T_J$  or increased  $R_G$ .
  - Pulse Test,  $t \leq 300\mu\text{s}$ ; Duty Cycle,  $d \leq 2\%$ .

### PRELIMINARY TECHNICAL INFORMATION

The product presented herein is under development. The Technical Specifications offered are derived from data gathered during objective characterizations of preliminary engineering lots; but also may yet contain some information supplied during a pre-production design evaluation. IXYS reserves the right to change limits, test conditions, and dimensions without notice.

### TO-268 (IXGT) Outline

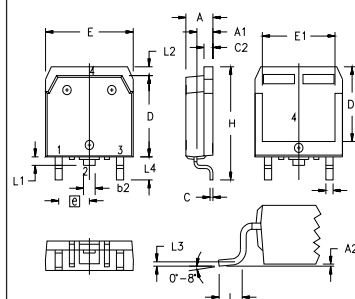

SYM	INCHES		MILLIMETERS	
	MIN	MAX	MIN	MAX
A	.193	.201	4.90	5.10
A <sub>1</sub>	.106	.114	2.70	2.90
A <sub>2</sub>	.001	.010	0.02	0.25
b	.045	.057	1.15	1.45
b <sub>2</sub>	.075	.083	1.90	2.10
C	.016	.026	0.40	0.65
C <sub>2</sub>	.057	.063	1.45	1.60
D	.543	.551	13.80	14.00
D <sub>1</sub>	.488	.500	12.40	12.70
E	.624	.632	15.85	16.05
E <sub>1</sub>	.524	.535	13.30	13.60
e	.215 BSC		5.45 BSC	
H	.736	.752	18.70	19.10
L	.094	.106	2.40	2.70
L <sub>1</sub>	.047	.055	1.20	1.40
L <sub>2</sub>	.039	.045	1.00	1.15
L <sub>3</sub>	.010 BSC		0.25 BSC	
L <sub>4</sub>	.150	.161	3.80	4.10

IXYS Reserves the Right to Change Limits, Test Conditions and Dimensions.

IXYS MOSFETs and IGBTs are covered by one or more of the following U.S. patents:	4,835,592	4,931,844	5,049,961	5,237,481	6,162,665	6,404,065 B1	6,683,344	6,727,585	7,005,734 B2	7,157,338B2
	4,850,072	5,017,508	5,063,307	5,381,025	6,259,123 B1	6,534,343	6,710,405 B2	6,759,692	7,063,975 B2	
	4,881,106	5,034,796	5,187,117	5,486,715	6,306,728 B1	6,583,505	6,710,463	6,771,478 B2	7,071,537	

**Fig. 1. Output Characteristics  
@ 25°C**

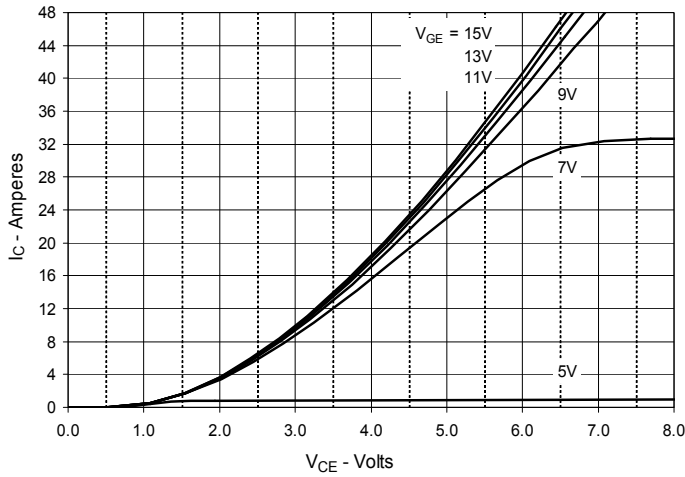

**Fig. 2. Extended Output Characteristics  
@ 25°C**

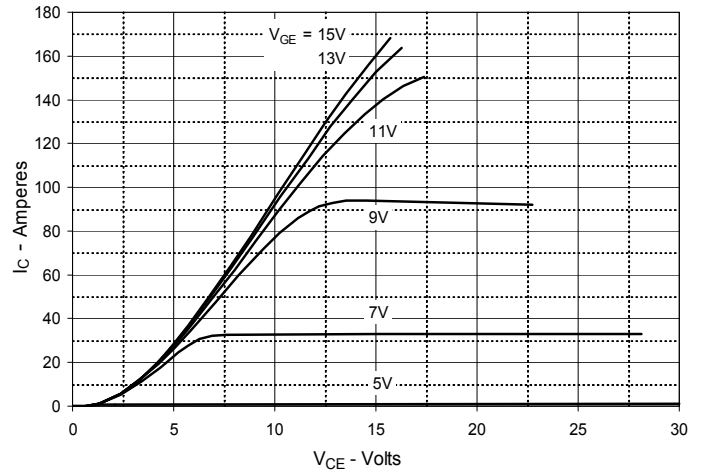

**Fig. 3. Output Characteristics  
@ 125°C**

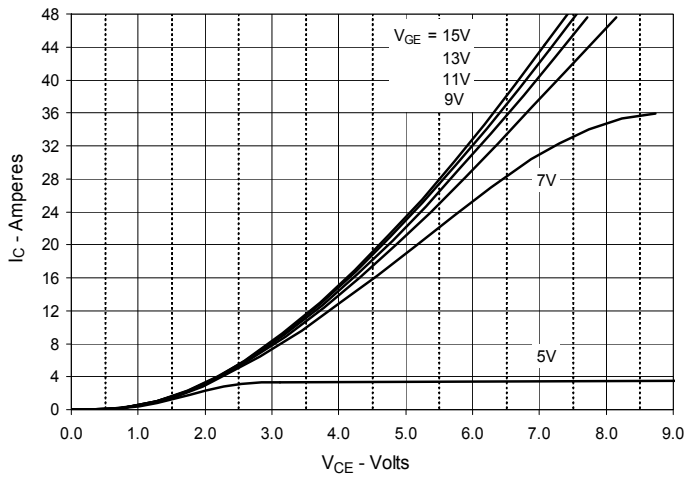

**Fig. 4. Dependence of VCE(sat) on  
Junction Temperature**

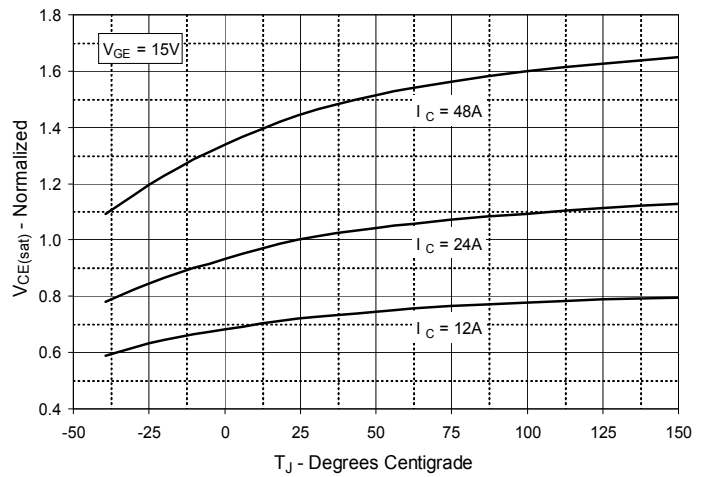

**Fig. 5. Collector-to-Emitter Voltage  
vs. Gate-to-Emitter Voltage**

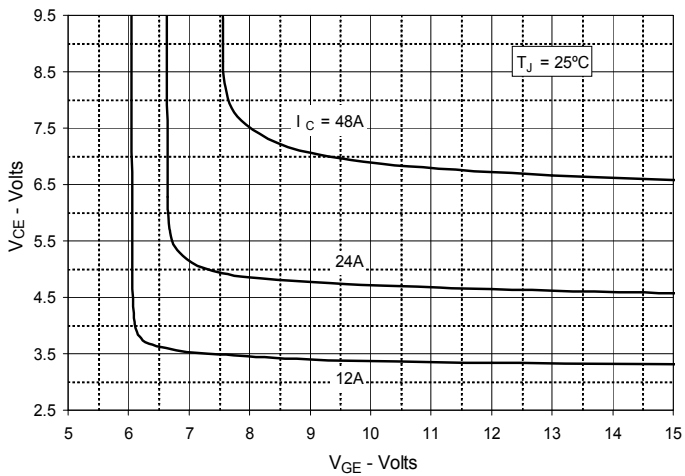

**Fig. 6. Input Admittance**

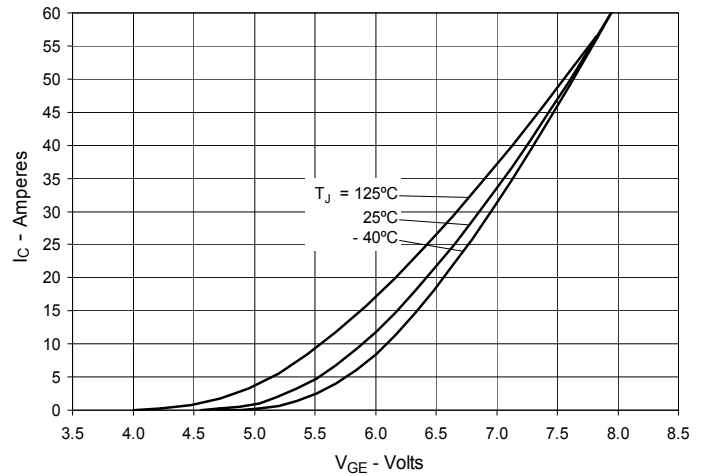

**Fig. 7. Transconductance**

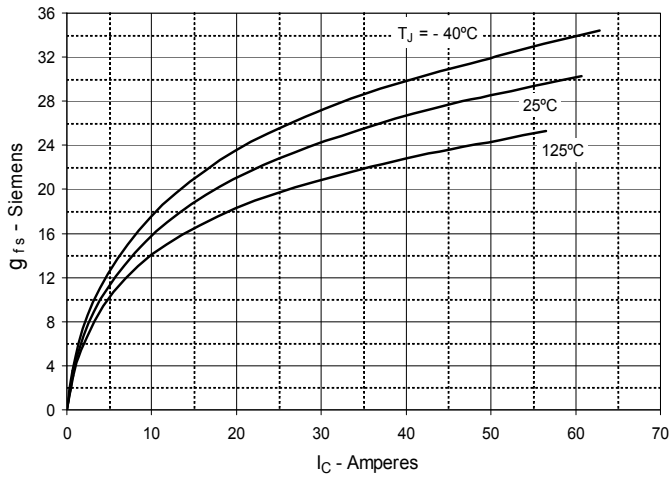

**Fig. 8. Gate Charge**

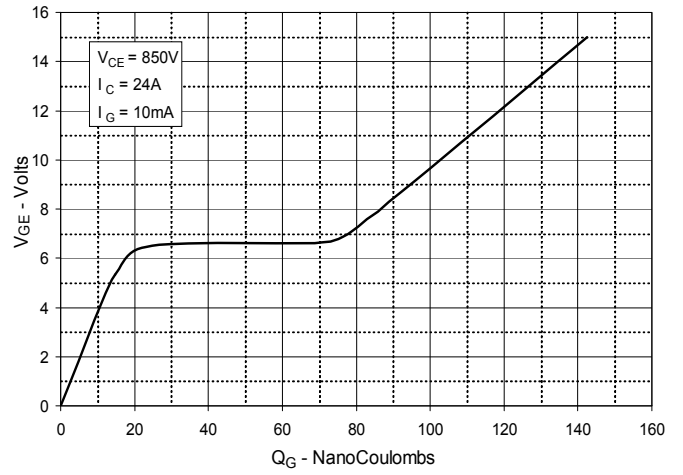

**Fig. 9. Capacitance**

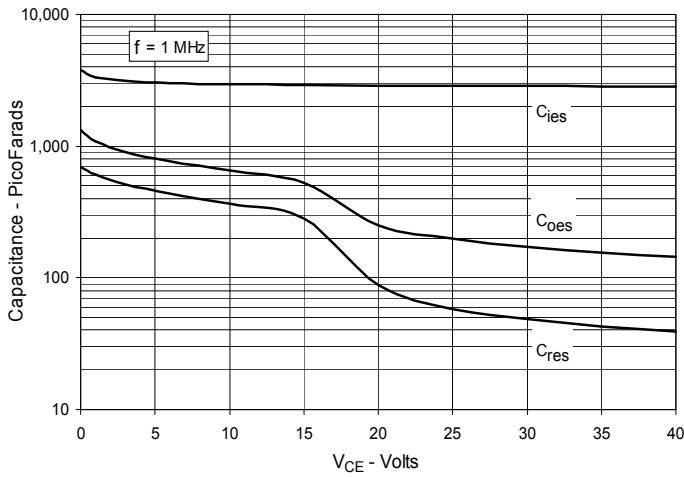

**Fig. 10. Reverse-Bias Safe Operating Area**

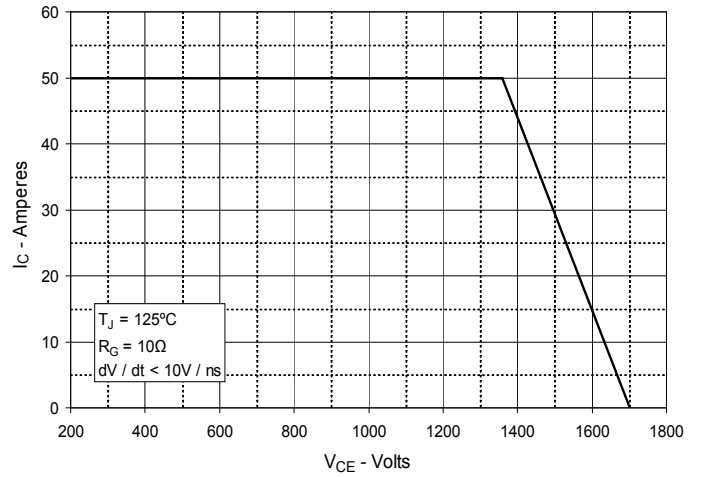

**Fig. 11. Maximum Transient Thermal Impedance**

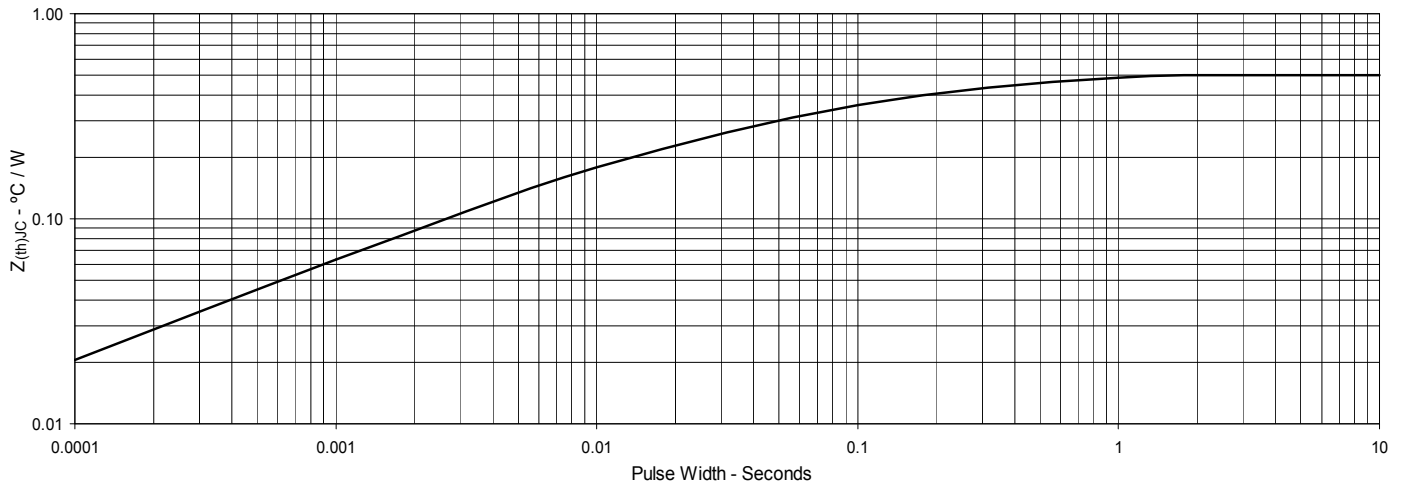

IXYS Reserves the Right to Change Limits, Test Conditions and Dimensions.



---

Disclaimer Notice - Information furnished is believed to be accurate and reliable. However, users should independently evaluate the suitability of and test each product selected for their own applications. Littelfuse products are not designed for, and may not be used in, all applications. Read complete Disclaimer Notice at [www.littelfuse.com/disclaimer-electronics](http://www.littelfuse.com/disclaimer-electronics).