

# High Voltage IGBT

**IXGH 16N170**  
**IXGT 16N170**

$V_{CES} = 1700 \text{ V}$   
 $I_{C25} = 32 \text{ A}$   
 $V_{CE(sat)} = 3.5 \text{ V}$

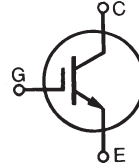

Symbol	Test Conditions	Maximum Ratings	
$V_{CES}$	$T_J = 25^\circ\text{C to } 150^\circ\text{C}$	1700	V
$V_{CGR}$	$T_J = 25^\circ\text{C to } 150^\circ\text{C}; R_{GE} = 1 \text{ M}\Omega$	1700	V
$V_{GES}$	Continuous	$\pm 20$	V
$V_{GEM}$	Transient	$\pm 30$	V
$I_{C25}$	$T_C = 25^\circ\text{C}$	32	A
$I_{C90}$	$T_C = 90^\circ\text{C}$	16	A
$I_{CM}$	$T_C = 25^\circ\text{C}, 1 \text{ ms}$	80	A
<b>SSOA (RBSOA)</b>	$V_{GE} = 15 \text{ V}, T_{VJ} = 125^\circ\text{C}, R_G = 10 \Omega$ Clamped inductive load	$I_{CM} = 40$ @ $0.8 V_{CES}$	A
$P_C$	$T_C = 25^\circ\text{C}$	190	W
$T_J$		-55 ... +150	$^\circ\text{C}$
$T_{JM}$		150	$^\circ\text{C}$
$T_{stg}$		-55 ... +150	$^\circ\text{C}$
$T_L$	1.6 mm (0.062 in.) from case for 10 s	300	$^\circ\text{C}$
$T_{SOLD}$	Plastic body for 10 s	260	$^\circ\text{C}$
$M_d$	Mounting torque (M3)	1.13/10Nm/lb.in.	
<b>Weight</b>	TO-247 AD	6	g
	TO-268	4	g

## TO-268 (D3-Pak) (IXGT)

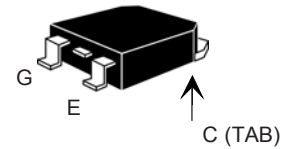

## TO-247 (IXGH)

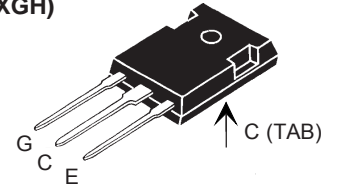

G = Gate, C = Collector,  
E = Emitter, TAB = Collector

## Features

- International standard packages JEDEC TO-268 and JEDEC TO-247 AD
- High current handling capability
- MOS Gate turn-on - drive simplicity
- Rugged NPT structure
- Molding epoxies meet UL 94 V-0 flammability classification

## Applications

- Capacitor discharge & pulser circuits
- AC motor speed control
- DC servo and robot drives
- DC choppers
- Uninterruptible power supplies (UPS)
- Switched-mode and resonant-mode power supplies

## Advantages

- High power density
- Suitable for surface mounting
- Easy to mount with 1 screw, (isolated mounting screw hole)

Symbol	Test Conditions	Characteristic Values ( $T_J = 25^\circ\text{C}$ , unless otherwise specified)		
		Min.	Typ.	Max.
$BV_{CES}$	$I_C = 250 \mu\text{A}, V_{GE} = 0 \text{ V}$	1700		V
$V_{GE(th)}$	$I_C = 250 \mu\text{A}, V_{CE} = V_{GE}$	3.0		V
$I_{CES}$	$V_{CE} = 0.8 \cdot V_{CES}$ $V_{GE} = 0 \text{ V}$	$T_J = 25^\circ\text{C}$		50 $\mu\text{A}$
		$T_J = 125^\circ\text{C}$		500 $\mu\text{A}$
$I_{GES}$	$V_{CE} = 0 \text{ V}, V_{GE} = \pm 20 \text{ V}$			$\pm 100 \text{ nA}$
$V_{CE(sat)}$	$I_C = I_{C90}, V_{GE} = 15 \text{ V}$	$T_J = 25^\circ\text{C}$	2.7	3.5 V
		$T_J = 125^\circ\text{C}$	3.3	V

Symbol	Test Conditions	Characteristic Values ( $T_J = 25^\circ\text{C}$ , unless otherwise specified)			
		Min.	Typ.	Max.	
$g_{fs}$	$I_C = I_{C90}$ ; $V_{CE} = 10\text{ V}$ , Pulse test, $t \leq 300\ \mu\text{s}$ , duty cycle $\leq 2\%$	10	14	S	
$I_{C(ON)}$	$V_{GE} = 10\text{ V}$ , $V_{CE} = 10\text{ V}$		65	A	
$C_{ies}$	$V_{CE} = 25\text{ V}$ , $V_{GE} = 0\text{ V}$ , $f = 1\text{ MHz}$		1650	pF	
$C_{oes}$			75	pF	
$C_{res}$			26	pF	
$Q_g$	$I_C = I_{C90}$ , $V_{GE} = 15\text{ V}$ , $V_{CE} = 0.5 V_{CES}$		78	nC	
$Q_{ge}$			13	nC	
$Q_{gc}$			24	nC	
$t_{d(on)}$	<b>Inductive load, <math>T_J = 25^\circ\text{C}</math></b> $I_C = I_{C90}$ , $V_{GE} = 15\text{ V}$ $V_{CE} = 0.8 V_{CES}$ , $R_G = R_{off} = 10\ \Omega$		45	ns	
$t_{ri}$			48	ns	
$t_{d(off)}$			400	600	ns
$t_{fi}$			770	1100	ns
$E_{off}$			9.3	14	mJ
$t_{d(on)}$	<b>Inductive load, <math>T_J = 125^\circ\text{C}</math></b> $I_C = I_{C90}$ , $V_{GE} = 15\text{ V}$ $V_{CE} = 0.8 V_{CES}$ , $R_G = R_{off} = 10\ \Omega$		48	ns	
$t_{ri}$			42	ns	
$E_{on}$			1.5	mJ	
$t_{d(off)}$			430	ns	
$t_{fi}$			1170	ns	
$E_{off}$		11.2	mJ		
$R_{thJC}$			0.65	$^\circ\text{C/W}$	
$R_{thCS}$	(TO-247)	0.25		$^\circ\text{C/W}$	

### TO-247 (IXGH) Outline

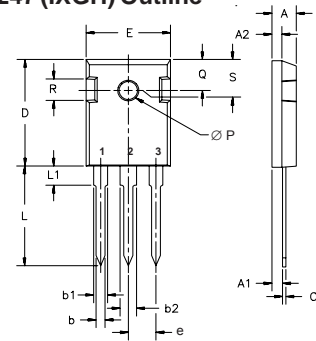

Terminals: 1 - Gate    2 - Drain  
3 - Source    Tab - Drain

Dim.	Millimeter		Inches	
	Min.	Max.	Min.	Max.
A	4.7	5.3	.185	.209
A <sub>1</sub>	2.2	2.54	.087	.102
A <sub>2</sub>	2.2	2.6	.059	.098
b	1.0	1.4	.040	.055
b <sub>1</sub>	1.65	2.13	.065	.084
b <sub>2</sub>	2.87	3.12	.113	.123
C	.4	.8	.016	.031
D	20.80	21.46	.819	.845
E	15.75	16.26	.610	.640
e	5.20	5.72	0.205	0.225
L	19.81	20.32	.780	.800
L <sub>1</sub>		4.50		.177
∅P	3.55	3.65	.140	.144
Q	5.89	6.40	0.232	0.252
R	4.32	5.49	.170	.216
S	6.15	BSC	242	BSC

### TO-268 (IXGT) Outline (D3-Pak)

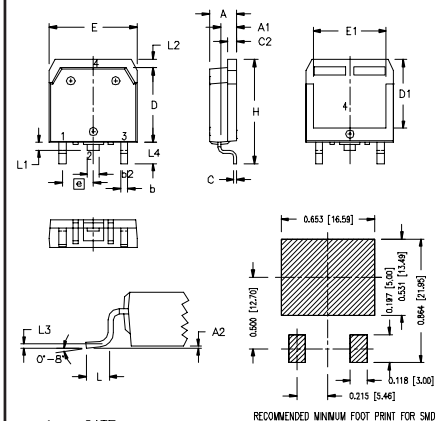

1 - GATE  
2 - DRAIN (COLLECTOR)  
3 - SOURCE (EMITTER)  
4 - DRAIN (COLLECTOR)

SYM	INCHES		MILLIMETERS	
	MIN	MAX	MIN	MAX
A	.193	.201	4.90	5.10
A <sub>1</sub>	.106	.114	2.70	2.90
A <sub>2</sub>	.091	.090	0.92	0.25
b	.045	.057	1.15	1.45
b <sub>2</sub>	.075	.083	1.90	2.10
C	.016	.026	0.40	0.65
C <sub>2</sub>	.057	.063	1.45	1.60
D	.543	.551	13.80	14.00
D <sub>1</sub>	.488	.500	12.40	12.70
E	.624	.632	15.85	16.05
E <sub>1</sub>	.524	.535	13.30	13.60
e	.215 BSC		5.45 BSC	
H	.736	.752	18.70	19.10
L	.094	.106	2.40	2.70
L <sub>1</sub>	.047	.055	1.20	1.40
L <sub>2</sub>	.039	.045	1.00	1.15
L <sub>3</sub>	.010 BSC		0.25 BSC	
L <sub>4</sub>	.150	.161	3.80	4.10

RECOMMENDED MINIMUM FOOT PRINT FOR SMD

IXYS reserves the right to change limits, test conditions, and dimensions.

IXYS MOSFETs and IGBTs are covered by one or more of the following U.S. patents:	4,835,592	4,931,844	5,049,961	5,237,481	6,162,665	6,404,065 B1	6,683,344	6,727,585	7,005,734 B2
	4,850,072	5,017,508	5,063,307	5,381,025	6,259,123 B1	6,534,343	6,710,405 B2	6,759,692	
	4,881,106	5,034,796	5,187,117	5,486,715	6,306,728 B1	6,583,505	6,710,463	6,771,478 B2	

Ref: IXYS CO 0052 RA

**Fig. 1. Output Characteristics**  
@ 25 Deg. C

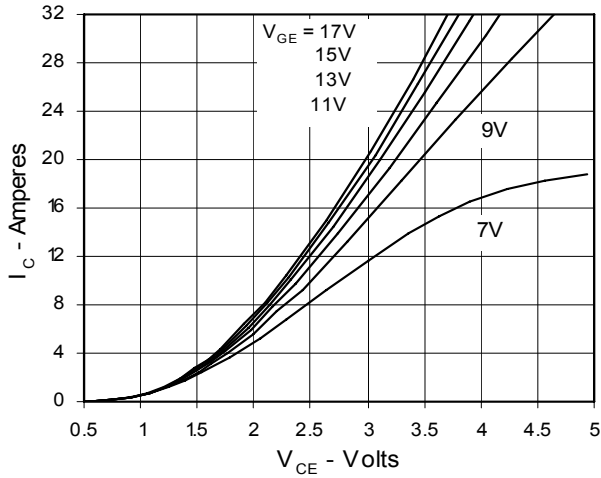

**Fig. 2. Extended Output Characteristics**  
@ 25 Deg. C

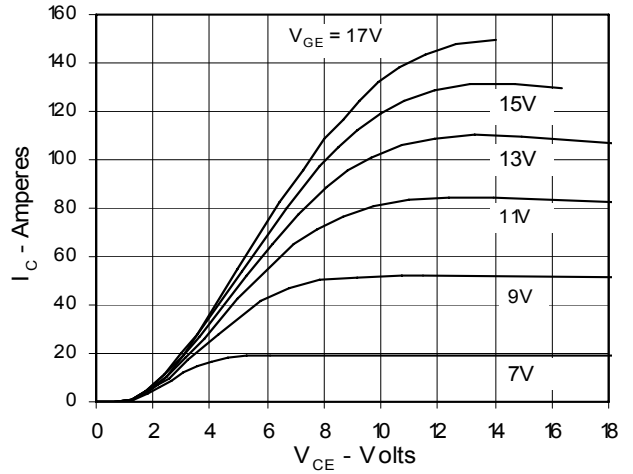

**Fig. 3. Output Characteristics**  
@ 125 Deg. C

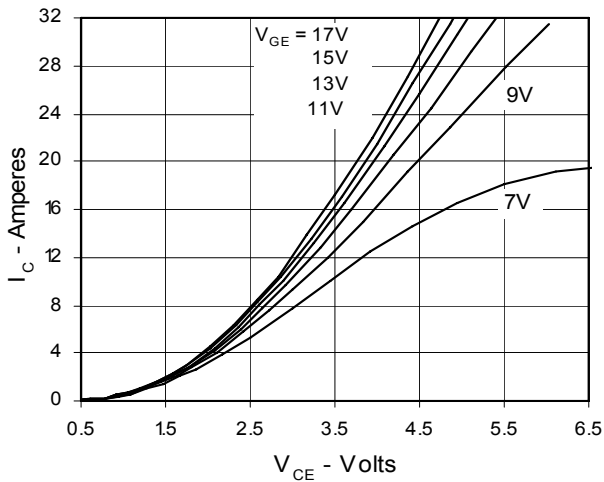

**Fig. 4. Temperature Dependence of  $V_{CE(sat)}$**

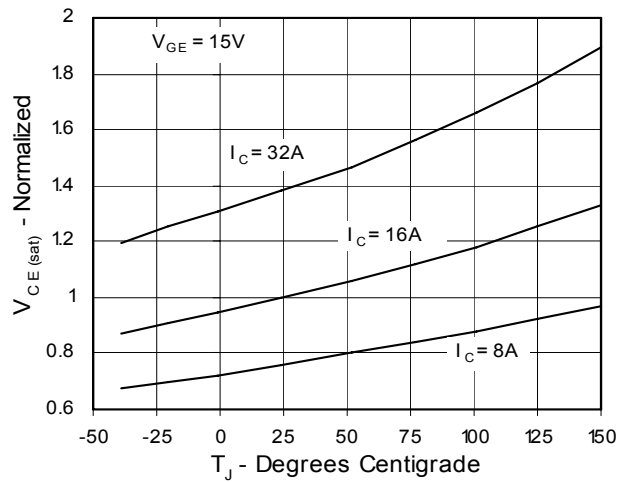

**Fig. 5. Collector-to-Emitter Voltage vs. Gate-to-Emitter voltage**

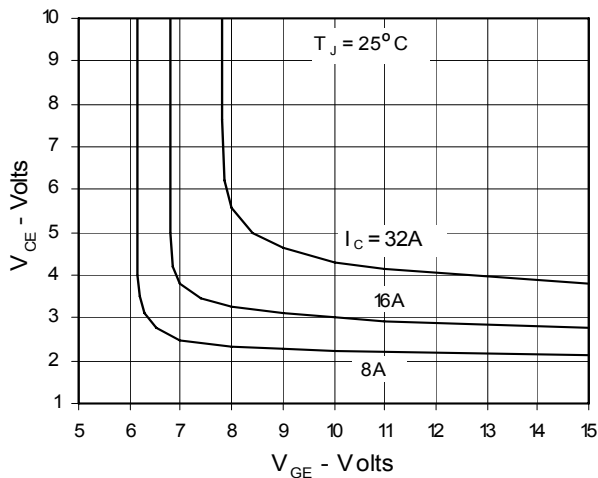

**Fig. 6. Input Admittance**

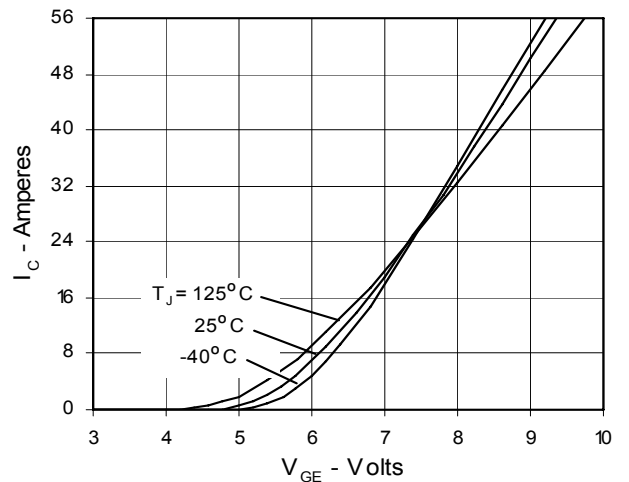

Fig. 7. Transconductance

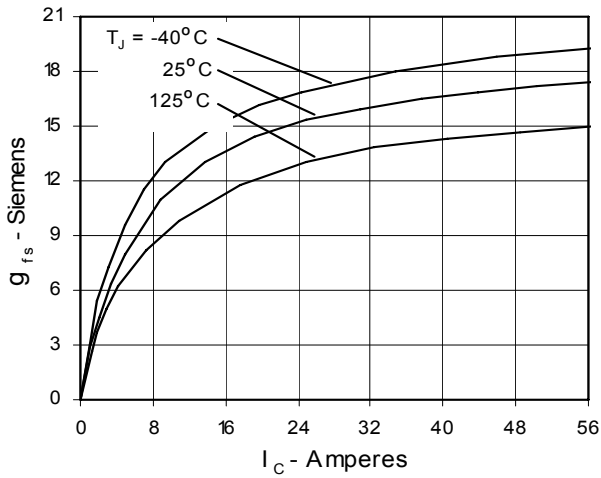

Fig. 8. Dependence of  $E_{off}$  on  $R_G$

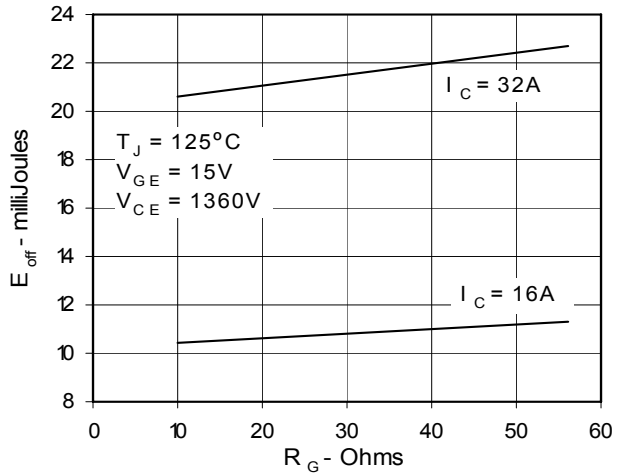

Fig. 9. Dependence of  $E_{off}$  on  $I_C$

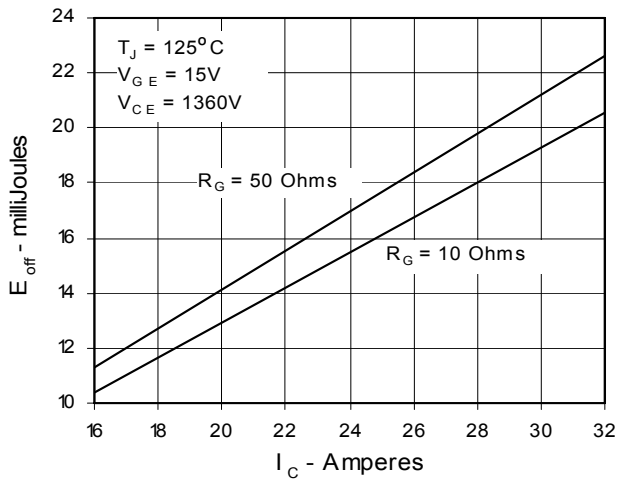

Fig. 10. Dependence of  $E_{off}$  on Temperature

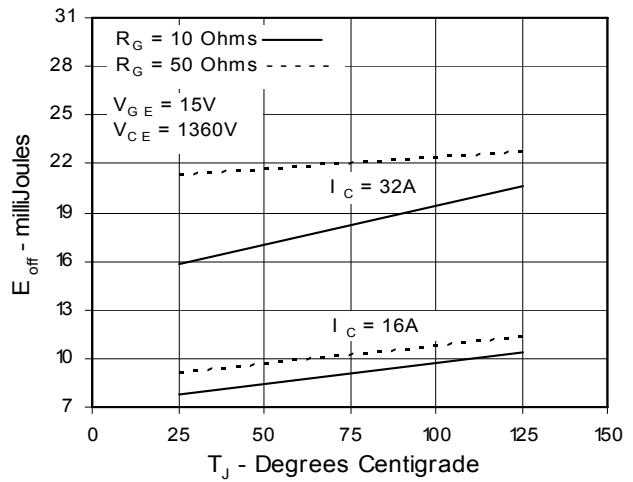

Fig. 11. Gate Charge

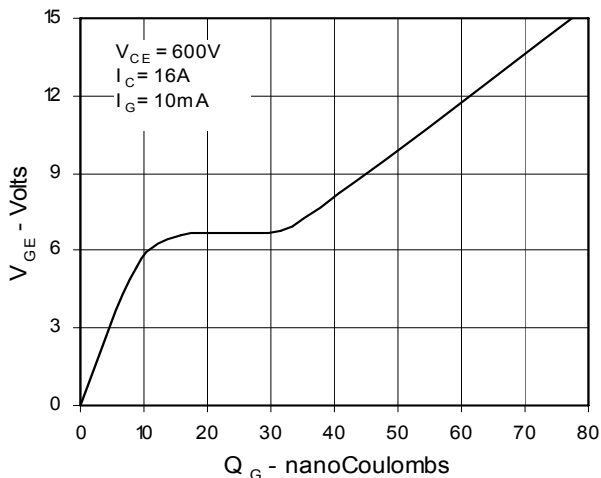
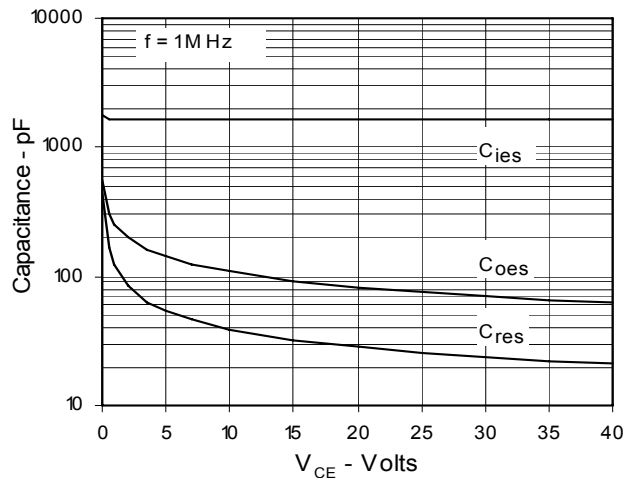
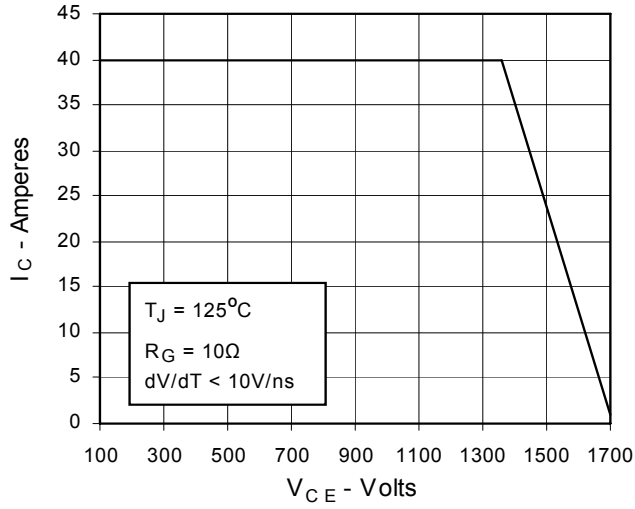

Fig. 12. Capacitance



**Fig. 13. Reverse-Bias Safe Operating Area**



**Fig. 14. Maximum Transient Thermal Resistance**

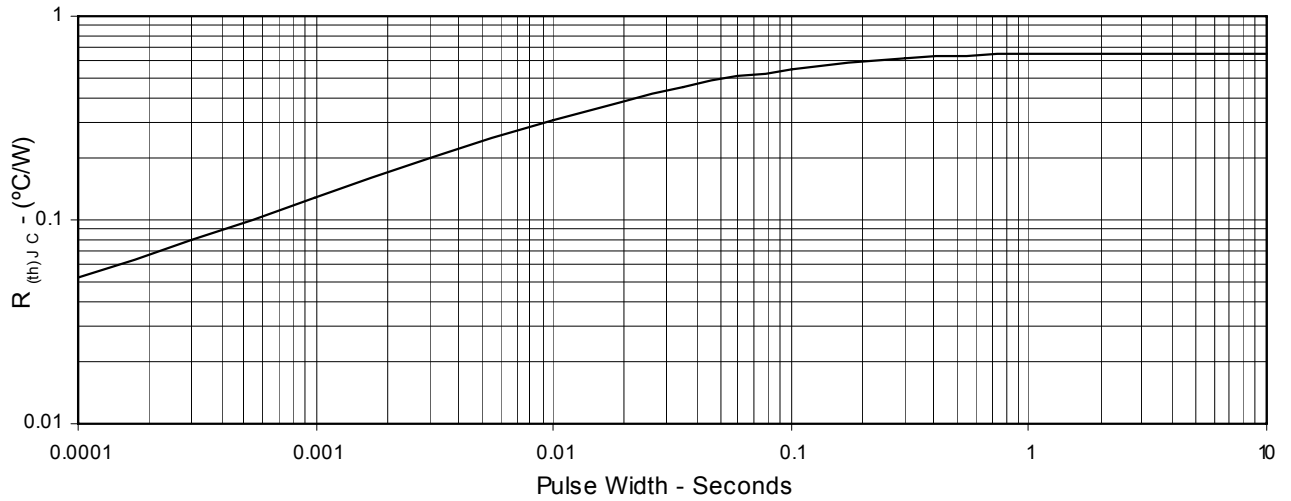



---

Disclaimer Notice - Information furnished is believed to be accurate and reliable. However, users should independently evaluate the suitability of and test each product selected for their own applications. Littelfuse products are not designed for, and may not be used in, all applications. Read complete Disclaimer Notice at [www.littelfuse.com/disclaimer-electronics](http://www.littelfuse.com/disclaimer-electronics).