

Insulated Gate Bi-Polar Transistor

Type T0510VB45E

Absolute Maximum Ratings

	VOLTAGE RATINGS	MAXIMUM LIMITS	UNITS
V_{CES}	Collector – emitter voltage	4500	V
$V_{DC\ link}$	Permanent DC voltage for 100 FIT failure rate.	2800	V
V_{GES}	Peak gate – emitter voltage	± 20	V

	RATINGS	MAXIMUM LIMITS	UNITS
$I_{C(DC)}$	DC collector current, IGBT	510	A
I_{CRM}	Repetitive peak collector current, $t_p=1\text{ms}$, IGBT	1020	A
I_{ECO}	Maximum reverse emitter current, $t_p=100\mu\text{s}$, (note 2 & 3)	510	A
P_{MAX}	Maximum power dissipation, IGBT (Note 2)	4.1	kW
T_j	Operating temperature range.	-40 to +125	$^{\circ}\text{C}$
T_{stg}	Storage temperature range.	-40 to +125	$^{\circ}\text{C}$

Notes: -

- 1) Unless otherwise indicated $T_j = 125^{\circ}\text{C}$.
- 2) $T_{sink} = 25^{\circ}\text{C}$, double side cooled.
- 3) The use of an-anti-parallel diode is recommended.

Characteristics

IGBT Characteristics

	PARAMETER	MIN	TYP	MAX	TEST CONDITIONS	UNITS	
$V_{CE(sat)}$	Collector – emitter saturation voltage	-	2.75	3.2	$I_C = 510A, V_{GE} = 15V, T_j = 25^\circ C$	V	
		-	3.60	4.0	$I_C = 510A, V_{GE} = 15V$	V	
V_{T0}	Threshold voltage	-	-	1.81	Current range: 170 – 510A	V	
r_T	Slope resistance	-	-	4.28		m Ω	
$V_{GE(TH)}$	Gate threshold voltage	-	5.2	-	$V_{CE} = V_{GE}, I_C = 55mA$	V	
I_{CES}	Collector – emitter cut-off current	-	15	35	$V_{CE} = V_{CES}, V_{GE} = 0V$	mA	
I_{GES}	Gate leakage current	-	-	± 10	$V_{GE} = \pm 20V$	μA	
C_{ies}	Input capacitance	-	90	-	$V_{CE} = 25V, V_{GE} = 0V, f = 1MHz$	nF	
$t_{d(on)}$	Turn-on delay time	-	3.8	-	$I_C = 510A, V_{CE} = 2800V, di/dt = 750A/\mu s$ $V_{GE} = \pm 15V, L_s = 200nH$ $R_{g(ON)} = 12\Omega, R_{g(OFF)} = 15\Omega, C_{GE} = 68nF$ Freewheel diode type E0660NC45C at 125°C (Notes 3, 4 & 5)	μs	
$t_r(V)$	Rise time	-	3.3	-		μs	
$Q_{g(on)}$	Turn-on gate charge	-	10	-		μC	
E_{on}	Turn-on energy	-	4.2	-		J	
$t_{d(off)}$	Turn-off delay time	-	2.3	-		μs	
$t_f(I)$	Fall time	-	2.7	-		μs	
$Q_{g(off)}$	Turn-off gate charge	-	14	-		μC	
E_{off}	Turn-off energy	-	2.1	-		J	
I_{SC}	Short circuit current	-	1650	-		$V_{GE} = +15V, V_{CC} = 2800V, V_{CEmax} \leq V_{CES}, t_p \leq 10\mu s$	A

Thermal Characteristics

	PARAMETER	MIN	TYP	MAX	TEST CONDITIONS	UNITS
R_{thJK}	Thermal resistance junction to sink, IGBT	-	-	24.3	Double side cooled	K/kW
		-	-	40.1	Collector side cooled	K/kW
		-	-	62.3	Emitter side cooled	K/kW
F	Mounting force	12	-	16	Note 2	kN
W_t	Weight	-	0.65	-		kg

Notes:-

- 1) Unless otherwise indicated $T_j = 125^\circ C$.
- 2) Consult application note 2008AN01 for detailed mounting requirements
- 3) C_{GE} is additional gate – emitter capacitance added to output of gate drive circuit
- 4) E_{on} integration time 15 μs from 10% rising I_G .
- 5) E_{off} integration time 15 μs from 90% falling V_{GE} .

Curves

Figure 1 – Typical collector-emitter saturation voltage characteristics

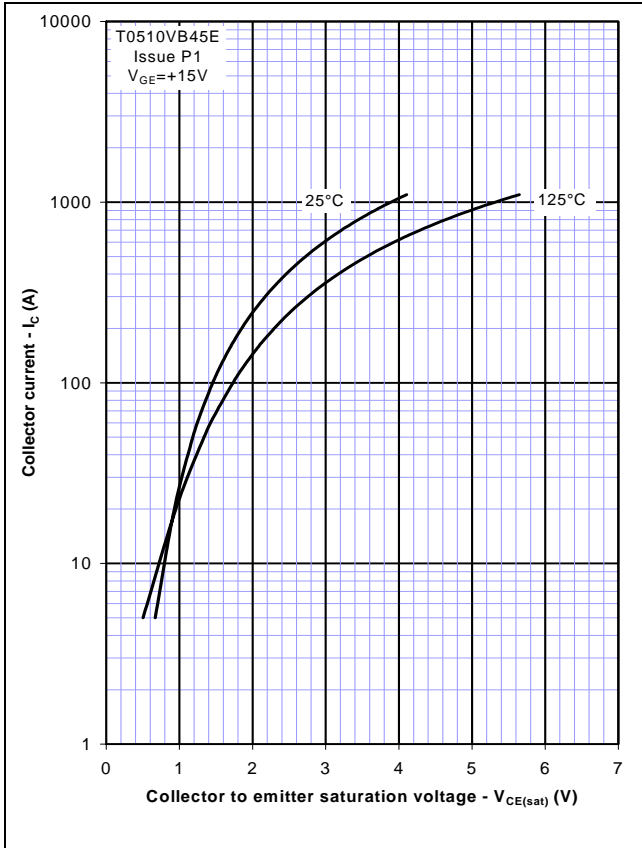

Figure 2 – Typical output characteristic

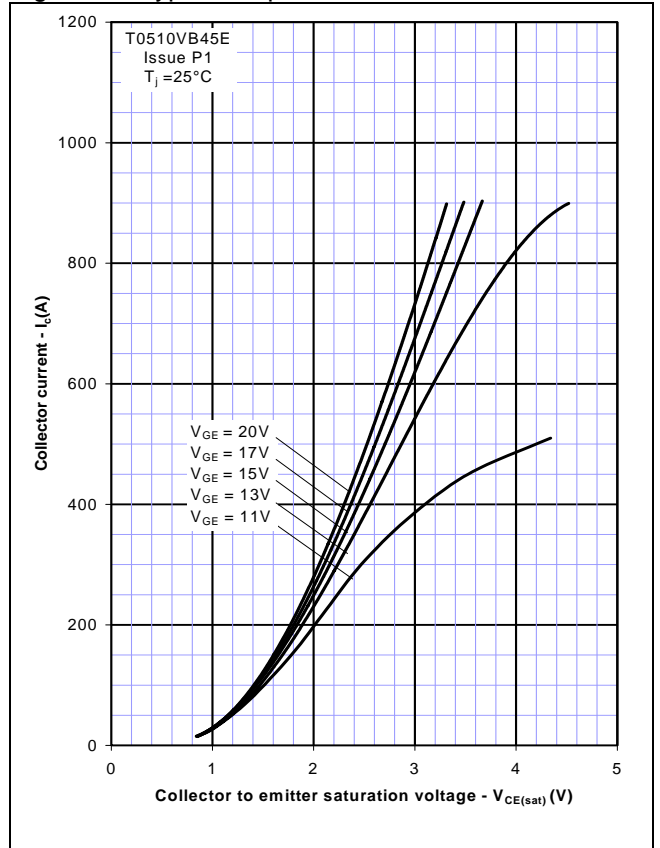

Figure 3 – Typical output characteristic

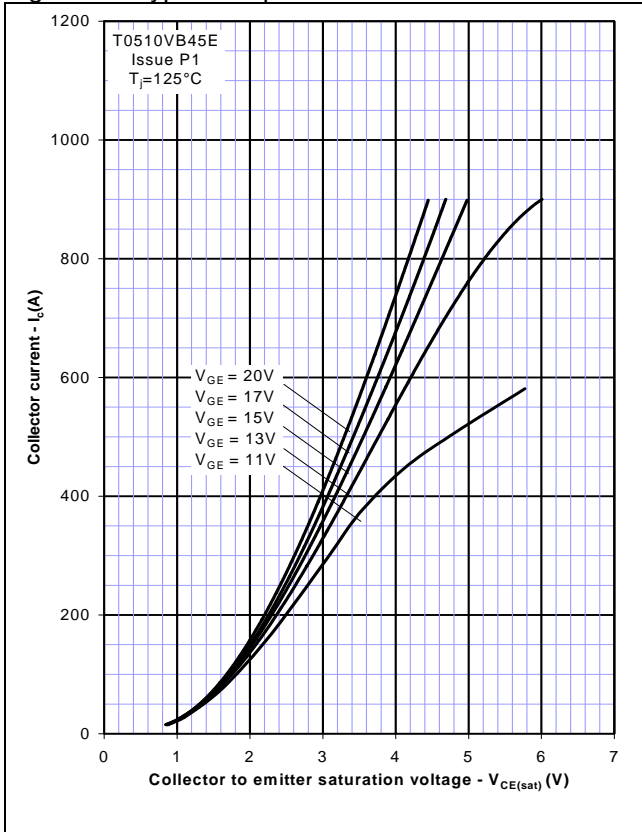

Figure 4 – Typical turn-on delay time vs gate resistance

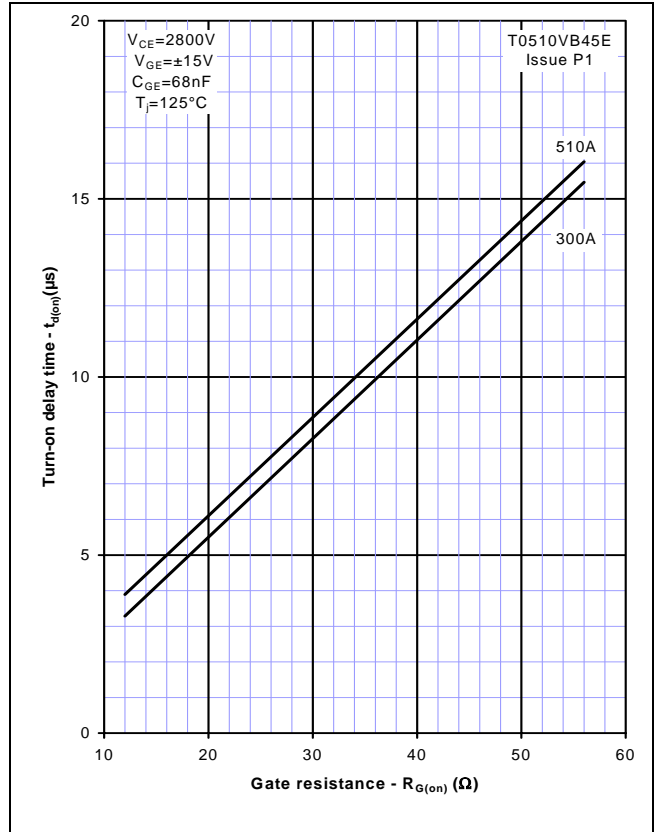

Figure 5 – Typical turn-off delay time vs. gate resistance

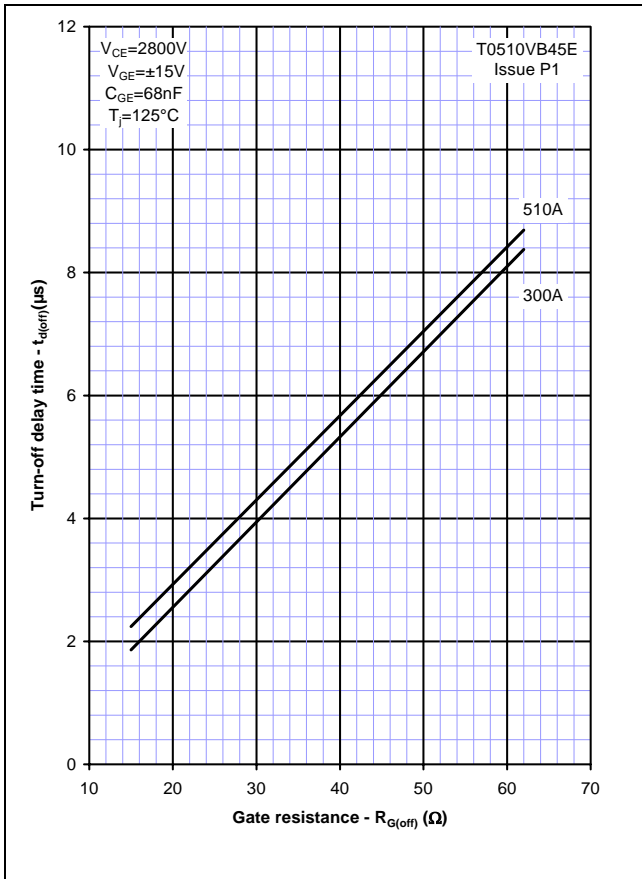

Figure 6 – Typical turn-on energy vs. collector current

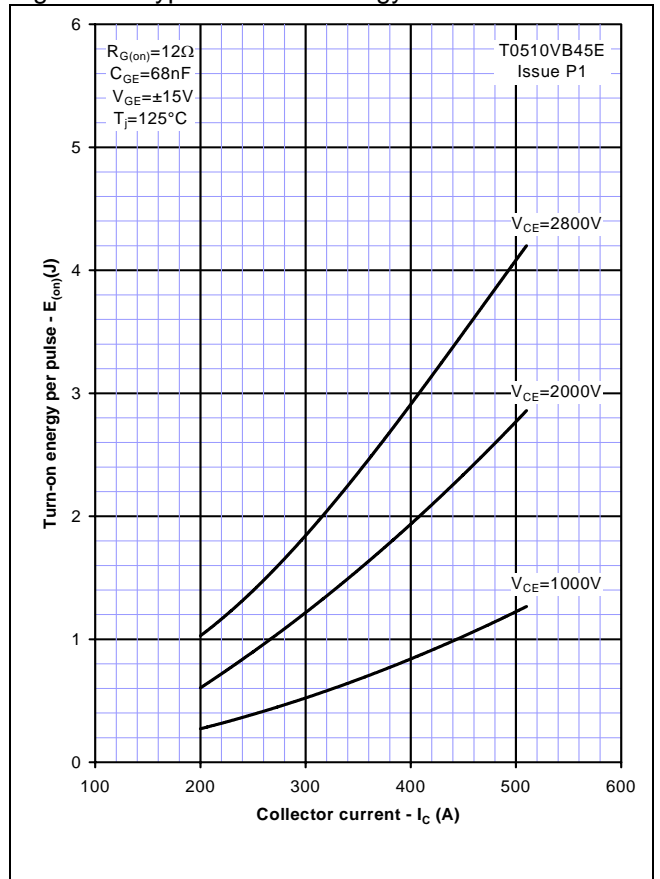

Figure 7 – Typical turn-on energy vs. di/dt

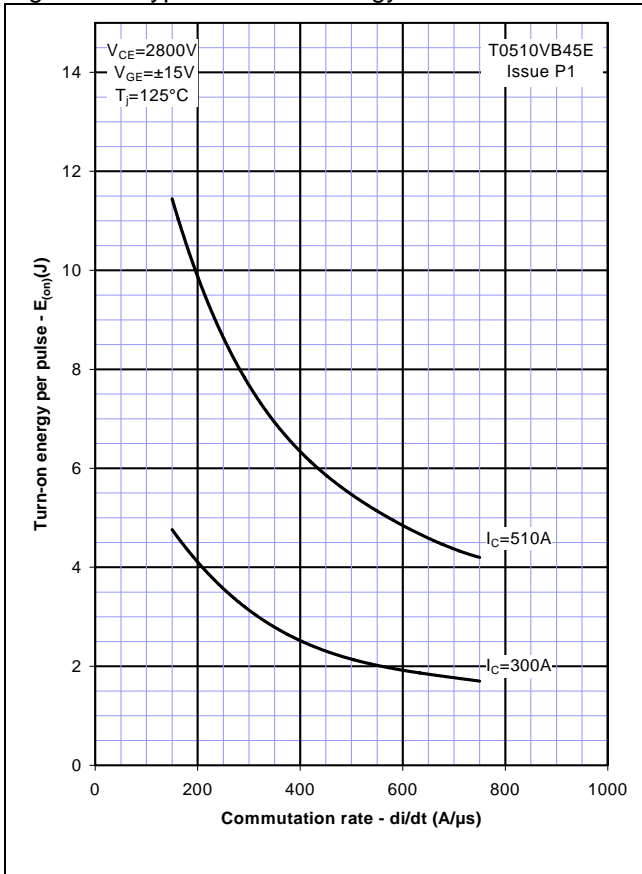

Figure 8 – Typical turn-off energy vs. collector current

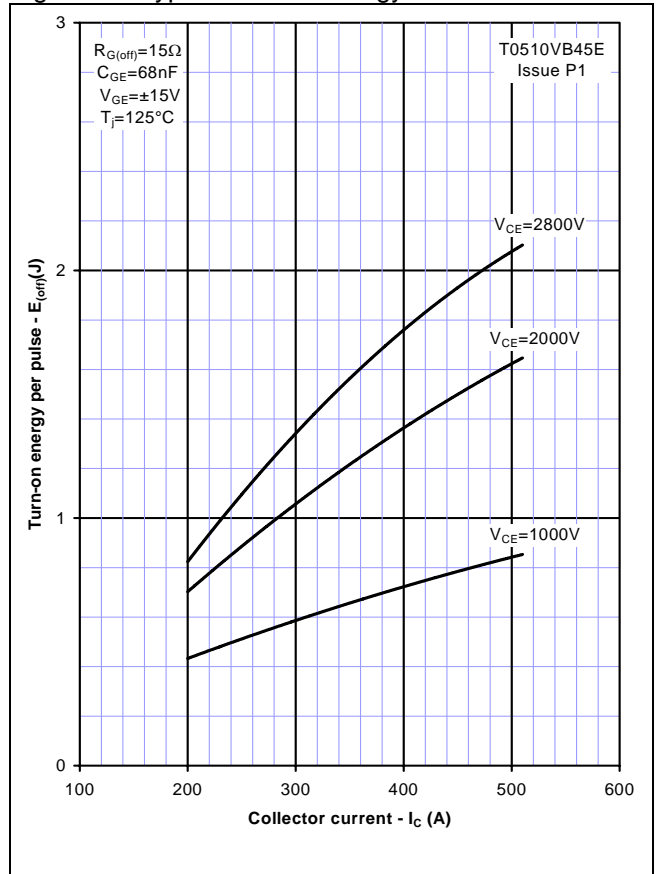

Figure 9 – Turn-off energy vs voltage

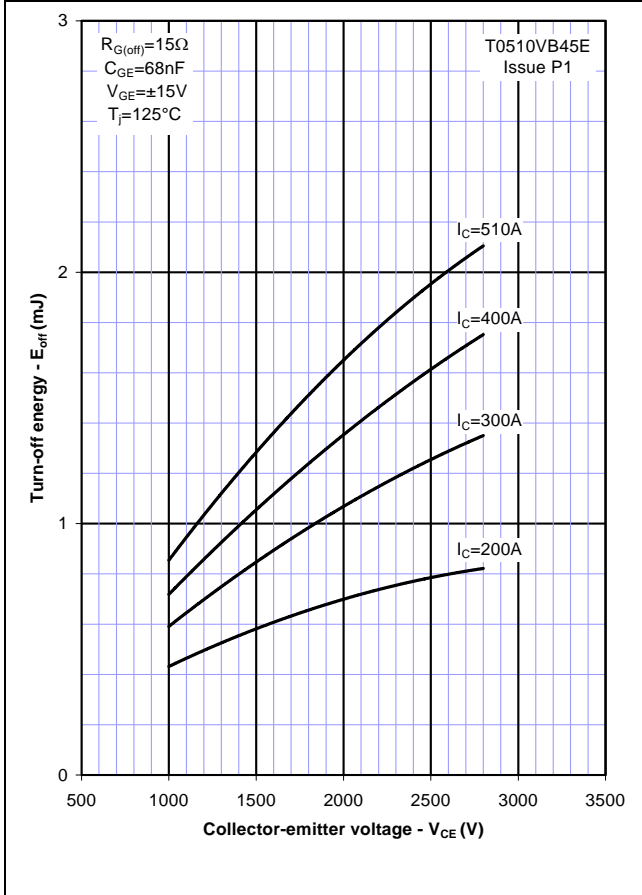

Figure 10 – Safe operating area

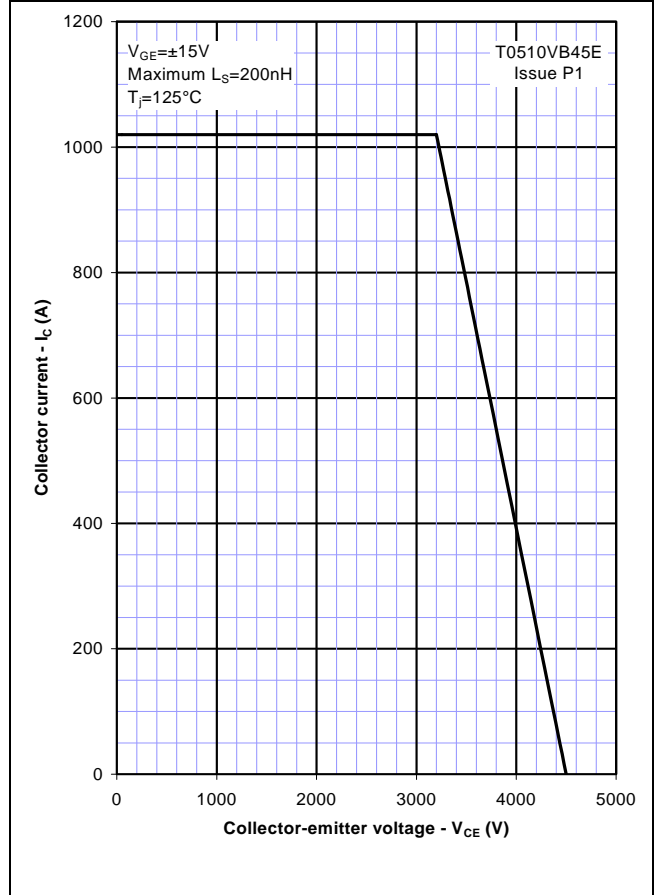
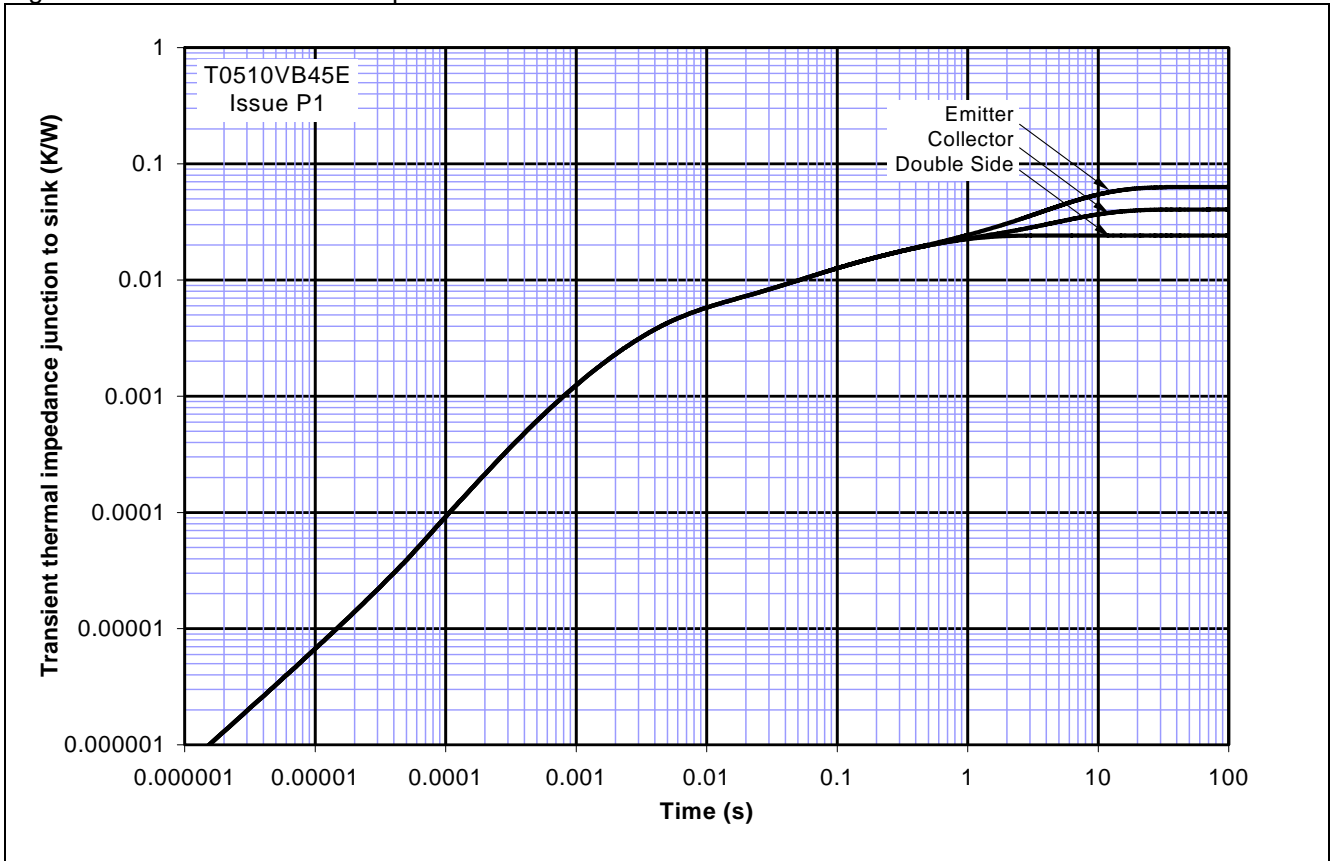
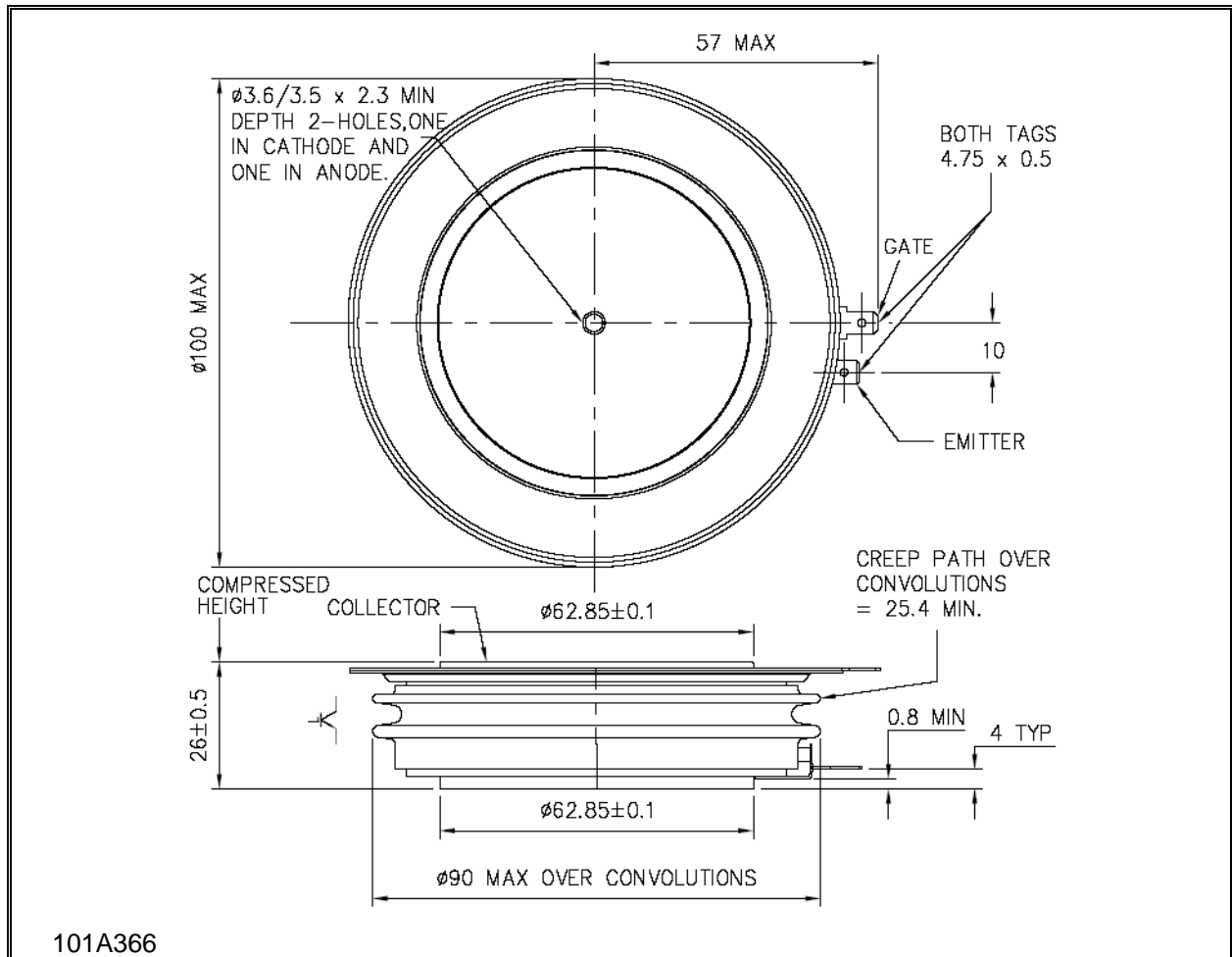

Figure 11 – Transient thermal impedance



Outline Drawing & Ordering Information



101A366

ORDERING INFORMATION

(Please quote 10 digit code as below)

T0510	VB	45	E
Fixed type Code	Fixed Outline Code	Voltage Grade $V_{CES}/100$ 45	Fixed format code

Typical order code: T0510VB45E ($V_{CES} = 4500V$)

IXYS Semiconductor GmbH
Edisonstraße 15
D-68623 Lampertheim
Tel: +49 6206 503-0
Fax: +49 6206 503-627
E-mail: marcom@ixys.de



IXYS UK Westcode Ltd
Langley Park Way, Langley Park,
Chippenham, Wiltshire, SN15 1GE.
Tel: +44 (0)1249 444524
Fax: +44 (0)1249 659448
E-mail: sales@ixysuk.com

IXYS Corporation
1590 Buckeye Drive
Milpitas CA 95035-7418
Tel: +1 (408) 457 9000
Fax: +1 (408) 496 0670
E-mail: sales@ixys.net

www.ixysuk.com

www.ixys.net

IXYS Long Beach
IXYS Long Beach, Inc
2500 Mira Mar Ave, Long Beach
CA 90815
Tel: +1 (562) 296 6584
Fax: +1 (562) 296 6585
E-mail: service@ixyslongbeach.com

The information contained herein is confidential and is protected by Copyright. The information may not be used or disclosed except with the written permission of and in the manner permitted by the proprietors IXYS UK Westcode Ltd.

© IXYS UK Westcode Ltd.

In the interest of product improvement, IXYS UK Westcode Ltd reserves the right to change specifications at any time without prior notice.

Devices with a suffix code (2-letter, 3-letter or letter/digit/letter combination) added to their generic code are not necessarily subject to the conditions and limits contained in this report.



Disclaimer Notice - Information furnished is believed to be accurate and reliable. However, users should independently evaluate the suitability of and test each product selected for their own applications. Littelfuse products are not designed for, and may not be used in, all applications. Read complete Disclaimer Notice at www.littelfuse.com/disclaimer-electronics.