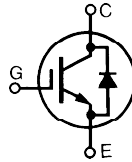


# High Voltage, High Gain BiMOSFET™

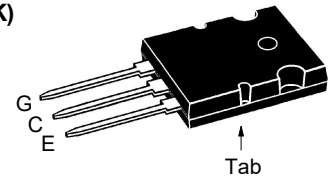
## IXBK55N300 IXBX55N300

$V_{CES} = 3000V$   
 $I_{C110} = 55A$   
 $V_{CE(sat)} \leq 3.2V$

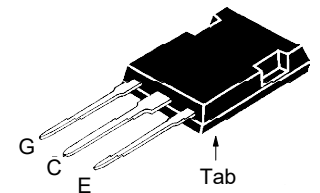
### Monolithic Bipolar MOS Transistor



TO-264  
(IXBK)



PLUS247  
(IXBX)



G = Gate                      E = Emitter  
 C = Collector                Tab = Collector

Symbol	Test Conditions	Maximum Ratings	
$V_{CES}$	$T_J = 25^\circ C$ to $150^\circ C$	3000	V
$V_{CGR}$	$T_J = 25^\circ C$ to $150^\circ C$ , $R_{GE} = 1M\Omega$	3000	V
$V_{GES}$	Continuous	$\pm 25$	V
$V_{GEM}$	Transient	$\pm 35$	V
$I_{C25}$	$T_C = 25^\circ C$ (Chip Capability)	130	A
$I_{C110}$	$T_C = 110^\circ C$	55	A
$I_{CM}$	$T_C = 25^\circ C$ , 1ms	600	A
<b>SSOA</b>	$V_{GE} = 15V$ , $T_{VJ} = 125^\circ C$ , $R_G = 2\Omega$	$I_{CM} = 110$	A
<b>(RBSOA)</b>	Clamped Inductive Load	1500	V
$T_{SC}$ <b>(SCSOA)</b>	$V_{GE} = 15V$ , $T_J = 125^\circ C$ , $R_G = 10\Omega$ , $V_{CE} = 1250V$ , Non-Repetitive	10	$\mu s$
$P_C$	$T_C = 25^\circ C$	625	W
$T_J$		-55 ... +150	$^\circ C$
$T_{JM}$		150	$^\circ C$
$T_{stg}$		-55 ... +150	$^\circ C$
$T_L$	Maximum Lead Temperature for Soldering 1.6 mm (0.062 in.) from Case for 10	300	$^\circ C$
$M_d$	Mounting Torque (TO-264)	1.13/10	Nm/lb.in
$F_C$	Mounting Force (PLUS247)	20..120/4.5..27	N/lb
<b>Weight</b>	TO-264	10	g
	PLUS247	6	g

#### Features

- High Blocking Voltage
- International Standard Packages
- Low Conduction Losses
- High Current Handling Capability
- MOS Gate Turn-On  
- Drive Simplicity

#### Advantages

- Easy to Mount
- Space Savings
- High Power Density

#### Applications

- Uninterruptible Power Supplies (UPS)
- Switch-Mode and Resonant-Mode Power Supplies
- Capacitor Discharge Circuits
- Laser Generators

Symbol	Test Conditions ( $T_J = 25^\circ C$ , Unless Otherwise Specified)	Characteristic Values		
		Min.	Typ.	Max.
$BV_{CES}$	$I_C = 1mA$ , $V_{GE} = 0V$	3000		V
$V_{GE(th)}$	$I_C = 4mA$ , $V_{CE} = V_{GE}$	3.0		5.0 V
$I_{CES}$	$V_{CE} = V_{CES}$ , $V_{GE} = 0V$ $T_J = 125^\circ C$			50 $\mu A$ 3 mA
$I_{GES}$	$V_{CE} = 0V$ , $V_{GE} = \pm 25V$			$\pm 200$ nA
$V_{CE(sat)}$	$I_C = 55A$ , $V_{GE} = 15V$ , Note 1 $T_J = 125^\circ C$		2.7 3.3	3.2 V V

Symbol Test Conditions ( $T_J = 25^\circ\text{C}$ Unless Otherwise Specified)		Characteristic Values		
		Min.	Typ.	Max.
$g_{fs}$	$I_C = 55\text{A}, V_{CE} = 10\text{V}$ , Note 1	32	50	S
$C_{ies}$	} $V_{CE} = 25\text{V}, V_{GE} = 0\text{V}, f = 1\text{MHz}$		7300	pF
$C_{oes}$			275	pF
$C_{res}$			83	pF
$Q_g$	} $I_C = 55\text{A}, V_{GE} = 15\text{V}, V_{CE} = 1000\text{V}$		335	nC
$Q_{ge}$			47	nC
$Q_{gc}$			130	nC
$t_{d(on)}$	} <b>Resistive Switching Times, <math>T_J = 25^\circ\text{C}</math></b> $I_C = 110\text{A}, V_{GE} = 15\text{V}$ $V_{CE} = 1250\text{V}, R_G = 2\Omega$		54	ns
$t_r$			307	ns
$t_{d(off)}$			230	ns
$t_f$			268	ns
$t_{d(on)}$	} <b>Resistive Switching Times, <math>T_J = 125^\circ\text{C}</math></b> $I_C = 110\text{A}, V_{GE} = 15\text{V}$ $V_{CE} = 1250\text{V}, R_G = 2\Omega$		52	ns
$t_r$			585	ns
$t_{d(off)}$			215	ns
$t_f$			260	ns
$R_{thJC}$				0.20 °C/W
$R_{thCS}$		0.15		°C/W

### Reverse Diode

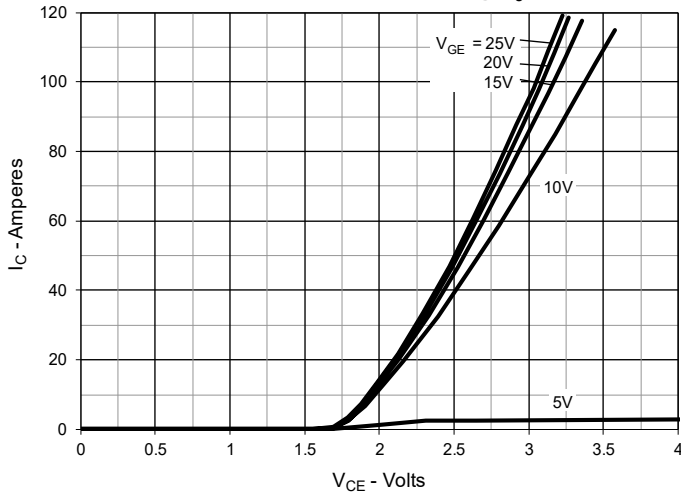
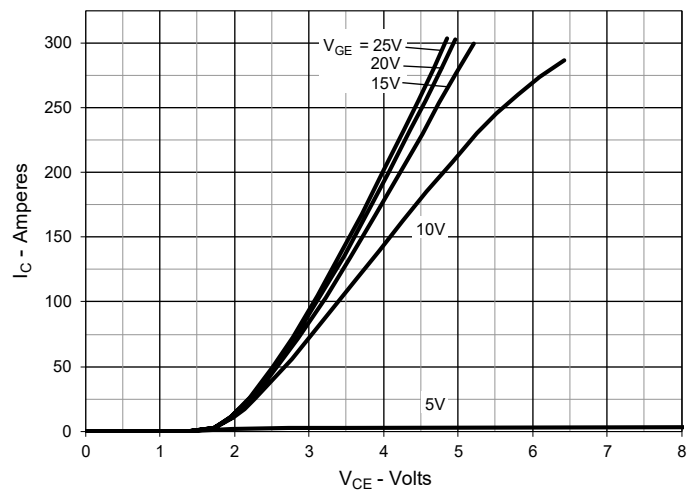
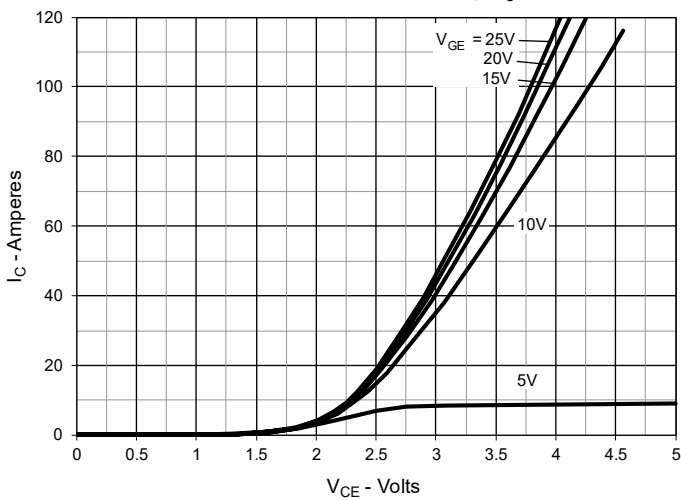
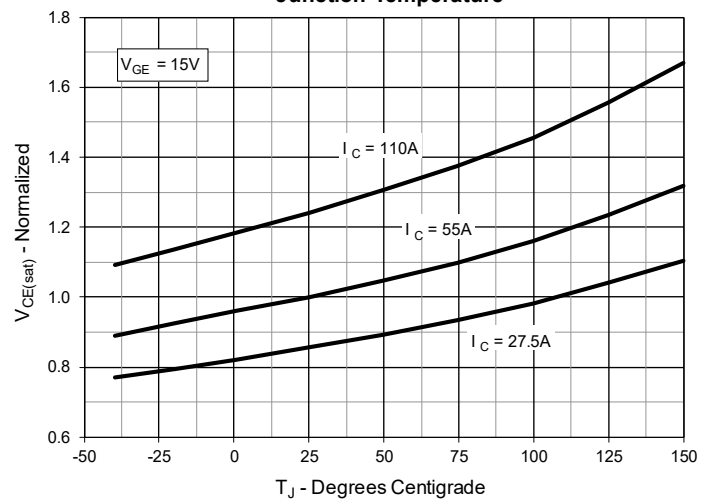
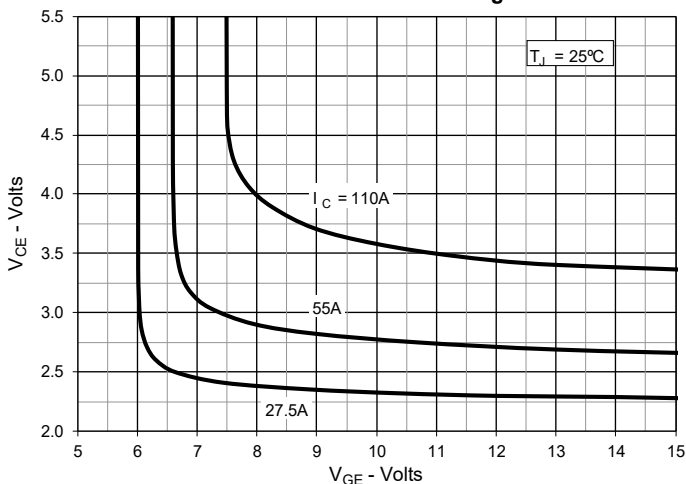
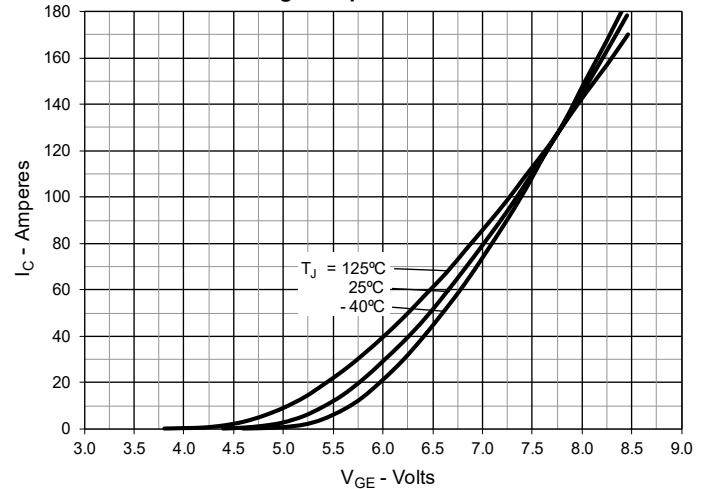
Symbol Test Conditions ( $T_J = 25^\circ\text{C}$ Unless Otherwise Specified)		Characteristic Values		
		Min.	Typ.	Max.
$V_F$	$I_F = 55\text{A}, V_{GE} = 0\text{V}$ , Note 1			2.5 V
$t_{rr}$	} $I_F = 28\text{A}, V_{GE} = 0\text{V}, -di_F/dt = 100\text{A}/\mu\text{s}$ $V_R = 100\text{V}, V_{GE} = 0\text{V}$		1.9	$\mu\text{s}$
$I_{RM}$			54	A

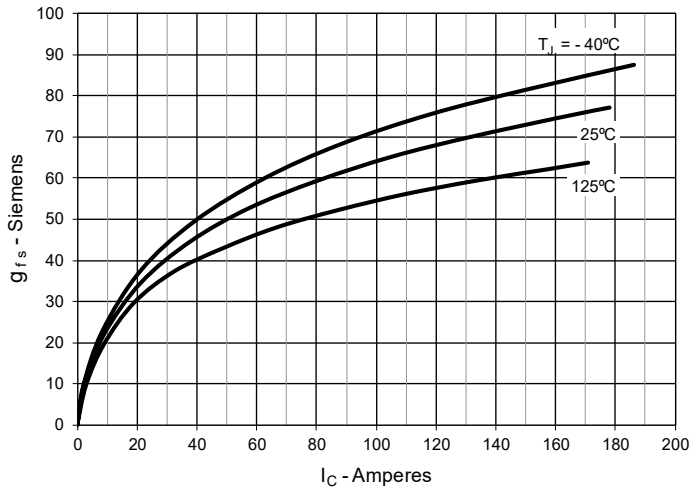
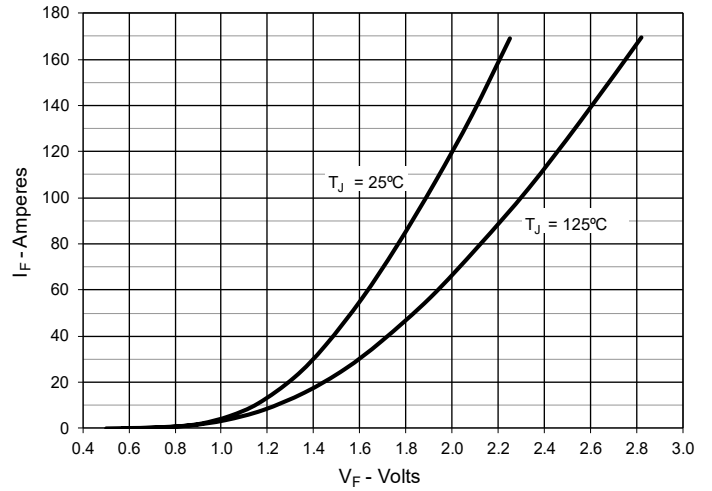
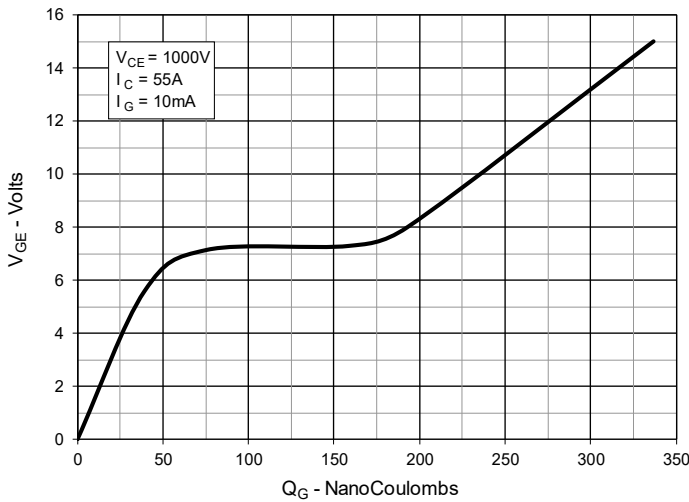
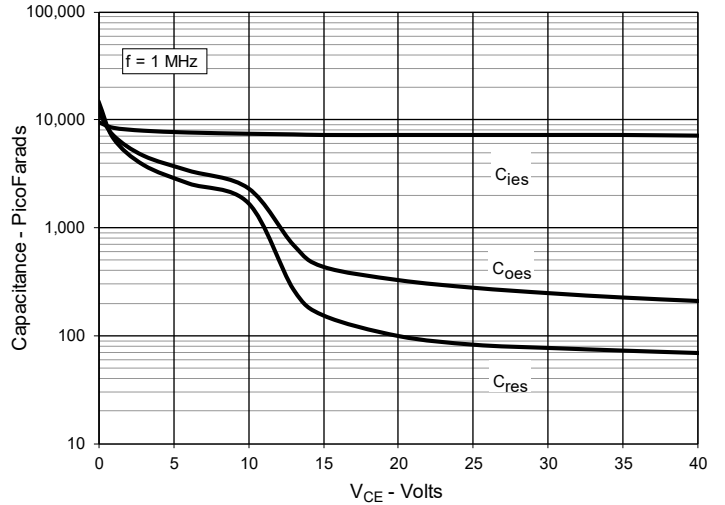
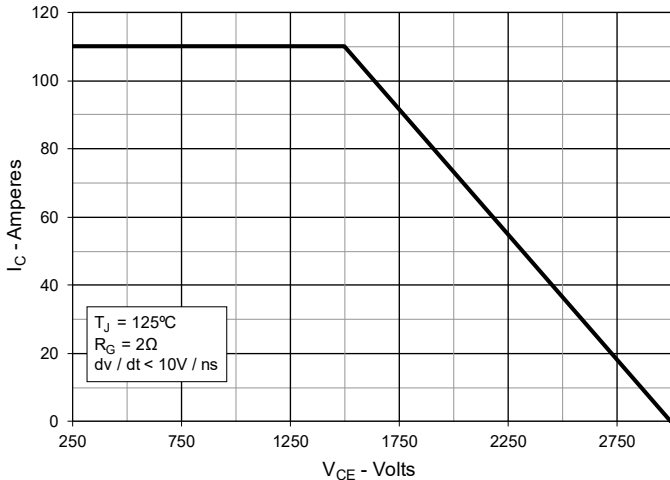
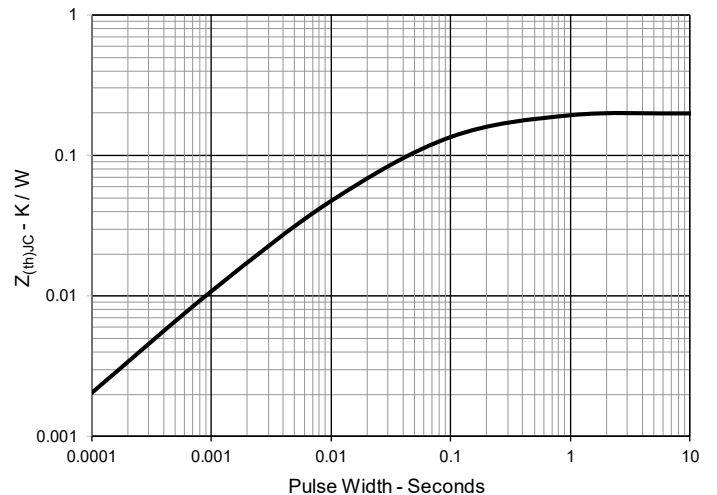
Note 1: Pulse Test,  $t \leq 300\mu\text{s}$ , Duty Cycle,  $d \leq 2\%$ .

Additional provisions for lead-to-lead isolation are required at  $V_{CE} > 1250\text{V}$ .

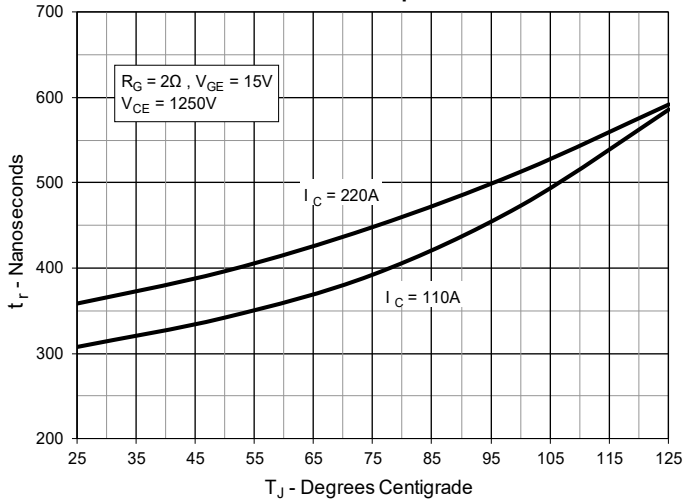
Littelfuse reserves the right to change limits, test conditions, and dimensions.

IXYS MOSFETs and IGBTs are covered by one or more of the following U.S. patents:	4,835,592	4,931,844	5,049,961	5,237,481	6,162,665	6,404,065 B1	6,683,344	6,727,585	7,005,734 B2	7,157,338 B2
	4,860,072	5,017,508	5,063,307	5,381,025	6,259,123 B1	6,534,343	6,710,405 B2	6,759,692	7,063,975 B2	
	4,881,106	5,034,796	5,187,117	5,486,715	6,306,728 B1	6,583,505	6,710,463	6,771,478 B2	7,071,537	

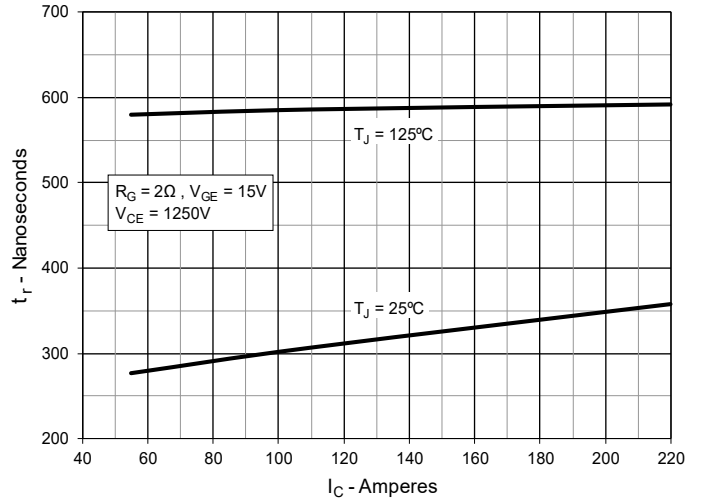
**Fig. 1. Output Characteristics @  $T_J = 25^\circ\text{C}$** 

**Fig. 2. Extended Output Characteristics @  $T_J = 25^\circ\text{C}$** 

**Fig. 3. Output Characteristics @  $T_J = 125^\circ\text{C}$** 

**Fig. 4. Dependence of  $V_{CE(sat)}$  on Junction Temperature**

**Fig. 5. Collector-to-Emitter Voltage vs. Gate-to-Emitter Voltage**

**Fig. 6. Input Admittance**


**Fig. 7. Transconductance**

**Fig. 8. Forward Voltage Drop of Intrinsic Diode**

**Fig. 9. Gate Charge**

**Fig. 10. Capacitance**

**Fig. 11. Reverse-Bias Safe Operating Area**

**Fig. 12. Maximum Transient Thermal Impedance**


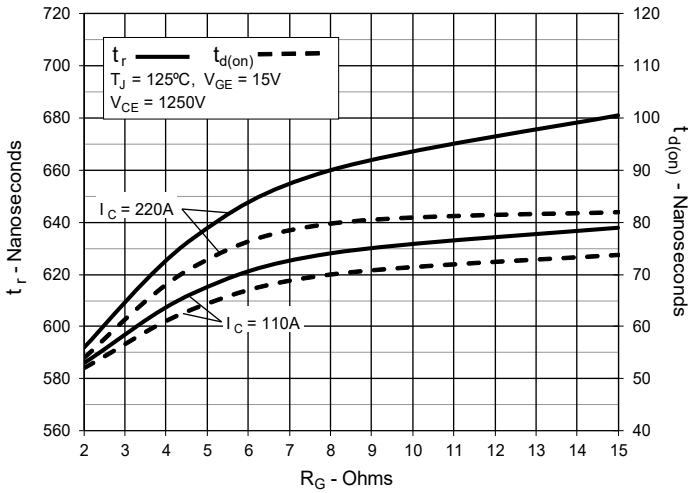
**Fig. 13. Resistive Turn-on Rise Time vs. Junction Temperature**



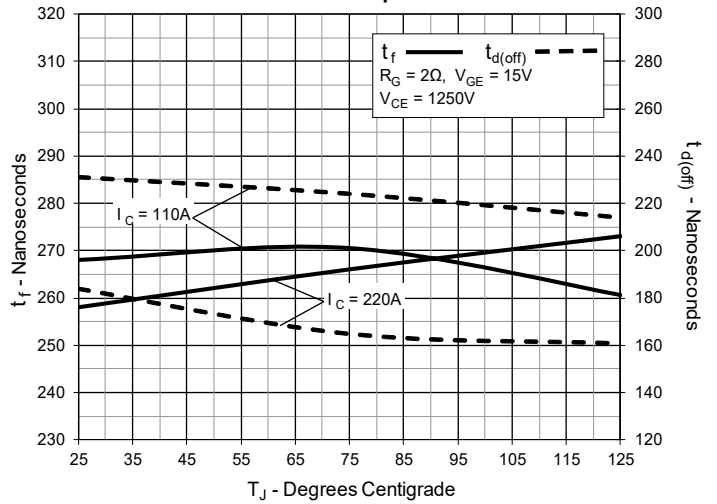
**Fig. 14. Resistive Turn-on Rise Time vs. Collector Current**



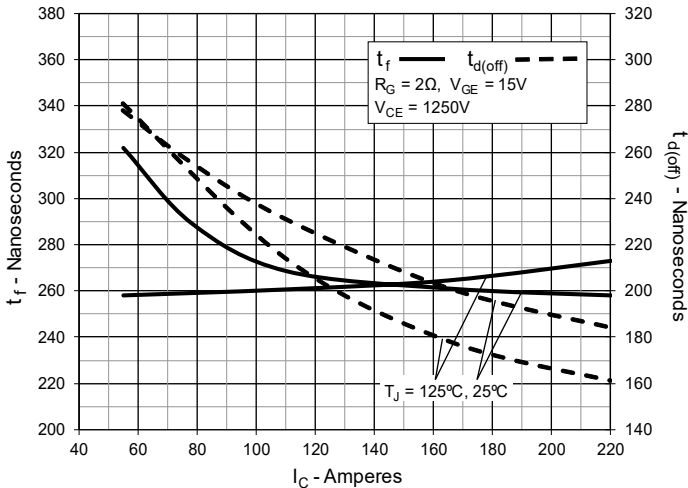
**Fig. 15. Resistive Turn-on Switching Times vs. Gate Resistance**



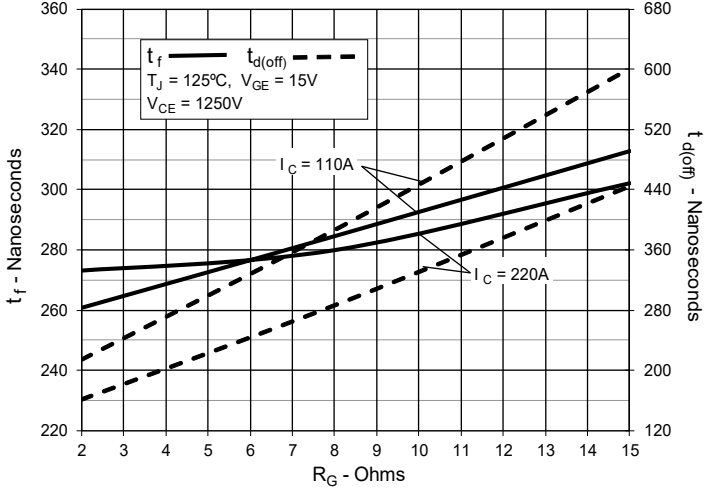
**Fig. 16. Resistive Turn-off Switching Times vs. Junction Temperature**



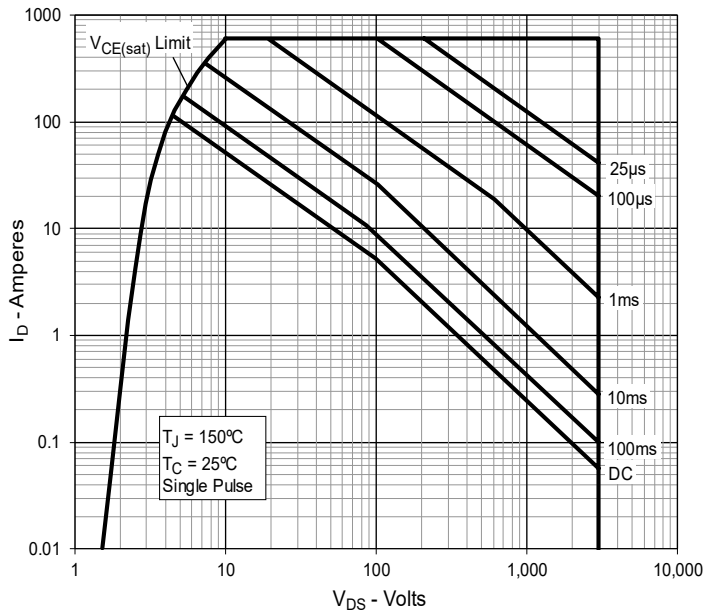
**Fig. 17. Resistive Turn-off Switching Times vs. Collector Current**



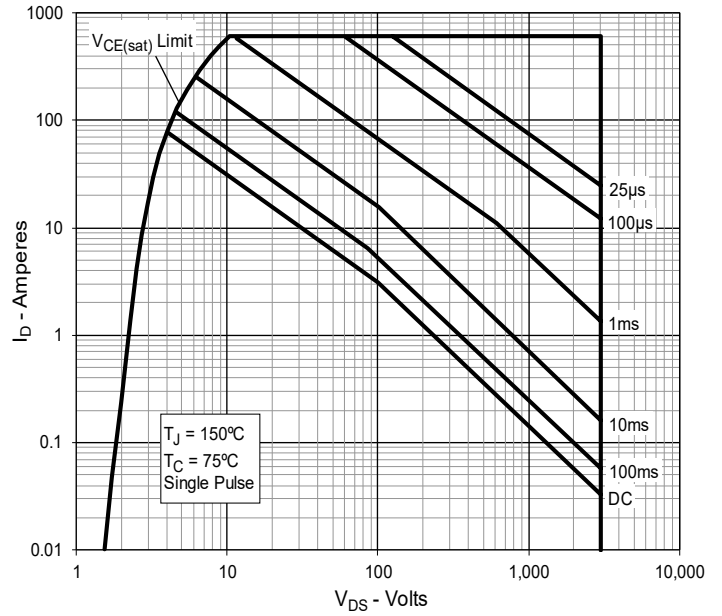
**Fig. 18. Resistive Turn-off Switching Times vs. Gate Resistance**

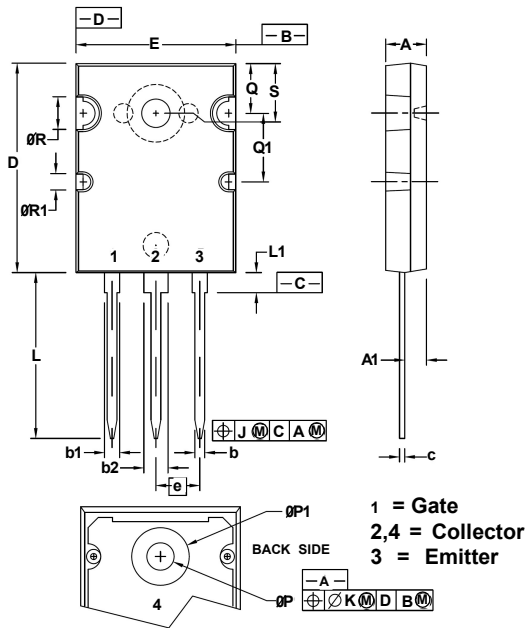


**Fig. 19. Forward-Bias Safe Operating Area**  
@  $T_C = 25^\circ\text{C}$

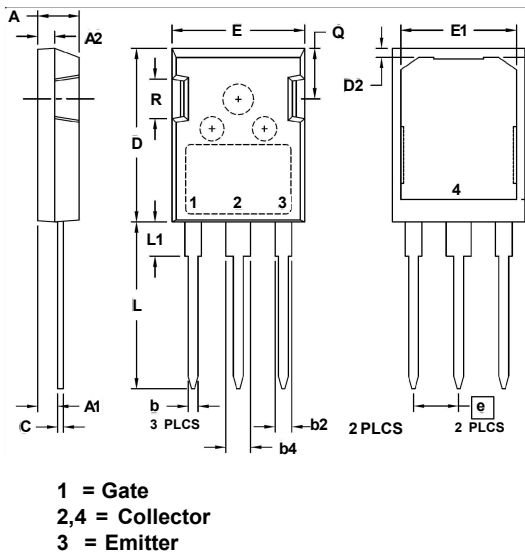


**Fig. 20. Forward-Bias Safe Operating Area**  
@  $T_C = 75^\circ\text{C}$



**TO-264 Outline**


SYMBOL	INCHES		MILLIMETERS	
	MIN	MAX	MIN	MAX
A	.185	.209	4.70	5.31
A1	.102	.118	2.59	3.00
b	.037	.055	0.94	1.40
b1	.087	.102	2.21	2.59
b2	.110	.126	2.79	3.20
c	.017	.029	0.43	0.74
D	1.007	1.047	25.58	26.59
E	.760	.799	19.30	20.29
e	.215 BSC		5.46 BSC	
J	.000	.010	0.00	0.25
K	.000	.010	0.00	0.25
L	.779	.842	19.79	21.39
L1	.087	.102	2.21	2.59
ØP	.122	.138	3.10	3.51
ØP1	.270	.290	6.86	7.37
Q	.240	.256	6.10	6.50
Q1	.330	.346	8.38	8.79
ØR	.155	.187	3.94	4.75
ØR1	.085	.093	2.16	2.36
S	.243	.253	6.17	6.43

**PLUS247™ Outline**


SYM	INCHES		MILLIMETERS	
	MIN	MAX	MIN	MAX
A	.190	.205	4.83	5.21
A1	.090	.100	2.29	2.54
A2	.075	.085	1.91	2.16
b	.045	.055	1.14	1.40
b2	.075	.087	1.91	2.20
b4	.115	.126	2.92	3.20
C	.024	.031	0.61	0.80
D	.819	.840	20.80	21.34
D1	.650	.690	16.51	17.53
D2	.035	.050	0.89	1.27
E	.620	.635	15.75	16.13
E1	.520	.560	13.08	14.22
e	.215 BSC		5.45 BSC	
L	.780	.810	19.81	20.57
L1	.150	.170	3.81	4.32
Q	.220	.244	5.59	6.20
R	.170	.190	4.32	4.83



---

Disclaimer Notice - Information furnished is believed to be accurate and reliable. However, users should independently evaluate the suitability of and test each product selected for their own applications. Littelfuse products are not designed for, and may not be used in, all applications. Read complete Disclaimer Notice at [www.littelfuse.com/disclaimer-electronics](http://www.littelfuse.com/disclaimer-electronics).

Littelfuse reserves the right to change limits, test conditions, and dimensions.

---