

# High Voltage, High Gain BIMOSFET™ Monolithic Bipolar MOS Transistor

## IXBT42N170A IXBH42N170A

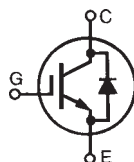

$$V_{CES} = 1700V$$

$$I_{C90} = 21A$$

$$V_{CE(sat)} \leq 6.0V$$

$$t_{fi} = 20ns$$

Symbol	Test Conditions	Maximum Ratings	
$V_{CES}$	$T_C = 25^\circ C$ to $150^\circ C$	1700	V
$V_{CGR}$	$T_J = 25^\circ C$ to $150^\circ C$ , $R_{GE} = 1M\Omega$	1700	V
$V_{GES}$	Continuous	$\pm 20$	V
$V_{GEM}$	Transient	$\pm 30$	V
$I_{C25}$	$T_C = 25^\circ C$	42	A
$I_{C90}$	$T_C = 90^\circ C$	21	A
$I_{CM}$	$T_C = 25^\circ C$ , 1ms	265	A
<b>SSOA</b> <b>(RBSOA)</b>	$V_{GE} = 15V$ , $T_{VJ} = 125^\circ C$ , $R_G = 10\Omega$ Clamped Inductive Load	$I_{CM} = 84$ 1360	A V
<b><math>T_{SC}</math></b> <b>(SCSOA)</b>	$V_{GE} = 15V$ , $V_{CES} = 1200V$ , $T_J = 125^\circ C$ $R_G = 10\Omega$ , non repetitive	10	$\mu s$
$P_C$	$T_C = 25^\circ C$	357	W
$T_J$		-55 ... +150	$^\circ C$
$T_{JM}$		150	$^\circ C$
$T_{stg}$		-55 ... +150	$^\circ C$
$T_L$	1.6mm (0.062 in.) from Case for 10s	300	$^\circ C$
$T_{SOLD}$	Plastic Body for 10 seconds	260	$^\circ C$
$M_d$	Mounting Torque (TO-247)	1.13/10	Nm/lb.in.
<b>Weight</b>	TO-268	4	g
	TO-247	6	g

TO-268 (IXBT)

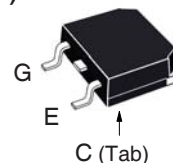

TO-247 (IXBH)

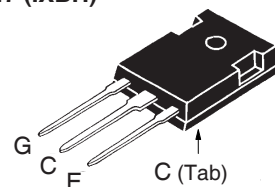

G = Gate      C = Collector  
E = Emitter    Tab = Collector

### Features

- High Blocking Voltage
- International Standard Packages
- Anti-Parallel Diode
- Low Conduction Losses

### Advantages

- Low Gate Drive Requirement
- High Power Density

### Applications

- Switch-Mode and Resonant-Mode Power Supplies
- Uninterruptible Power Supplies (UPS)
- AC Motor Drives
- Capacitor Discharge Circuits
- AC Switches

Symbol	Test Conditions ( $T_J = 25^\circ C$ Unless Otherwise Specified)	Characteristic Values		
		Min.	Typ.	Max.
$BV_{CES}$	$I_C = 250\mu A$ , $V_{GE} = 0V$	1700		V
$V_{GE(th)}$	$I_C = 750\mu A$ , $V_{CE} = V_{GE}$	2.5		V
$I_{CES}$	$V_{CE} = 0.8 \cdot V_{CES}$ , $V_{GE} = 0V$ $T_J = 125^\circ C$			50 $\mu A$ 1.5 mA
$I_{GES}$	$V_{CE} = 0V$ , $V_{GE} = \pm 20V$			$\pm 100$ nA
$V_{CE(sat)}$	$I_C = I_{C90}$ , $V_{GE} = 15V$ , Note 1 $T_J = 125^\circ C$		5.2	6.0 V
			5.3	V

Symbol	Test Conditions ( $T_J = 25^\circ\text{C}$ Unless Otherwise Specified)	Characteristic Values		
		Min.	Typ.	Max.
$g_{fs}$	$I_C = I_{C90}, V_{CE} = 10\text{V}$ , Note 1	14	23	S
$C_{ies}$	$V_{CE} = 25\text{V}, V_{GE} = 0\text{V}, f = 1\text{MHz}$		3920	pF
$C_{oes}$			275	pF
$C_{res}$			107	pF
$Q_{g(on)}$	$I_C = I_{C90}, V_{GE} = 15\text{V}, V_{CE} = 0.5 \cdot V_{CES}$		188	nC
$Q_{ge}$			23	nC
$Q_{gc}$			80	nC
$t_{d(on)}$	<b>Inductive load, <math>T_J = 25^\circ\text{C}</math></b> $I_C = I_{C90}, V_{GE} = 15\text{V}$ $V_{CE} = 0.5 \cdot V_{CES}, R_G = 1\Omega$ Diode Type = DH40-18A Note 2		19	ns
$t_{ri}$			17	ns
$E_{on}$			3.43	mJ
$t_{d(off)}$			200	ns
$t_{fi}$			20	ns
$E_{off}$			0.43	mJ
$t_{d(on)}$	<b>Inductive load, <math>T_J = 125^\circ\text{C}</math></b> $I_C = I_{C90}, V_{GE} = 15\text{V}$ $V_{CE} = 0.5 \cdot V_{CES}, R_G = 1\Omega$ Diode Type = DH40-18A Note 2		19	ns
$t_{ri}$			14	ns
$E_{on}$			5.40	mJ
$t_{d(off)}$			226	ns
$t_{fi}$			82	ns
$E_{off}$			0.83	mJ
$R_{thJC}$	TO-247			0.35 $^\circ\text{C/W}$
$R_{thCS}$			0.21	$^\circ\text{C/W}$

### Reverse Diode

Symbol	Test Conditions ( $T_J = 25^\circ\text{C}$ Unless Otherwise Specified)	Characteristic Values		
		Min.	Typ.	Max.
$V_F$	$I_F = I_{C90}, V_{GE} = 0\text{V}$			5.0 V
$t_{rr}$	$I_F = 25\text{A}, V_{GE} = 0\text{V}, -di_F/dt = 50\text{A}/\mu\text{s}$		330	ns
$I_{RM}$			15	A

Note 1: Pulse test,  $t \leq 300\mu\text{s}$ , duty cycle,  $d \leq 2\%$ .

### PRELIMINARY TECHNICAL INFORMATION

The product presented herein is under development. The Technical Specifications offered are derived from data gathered during objective characterizations of preliminary engineering lots; but also may yet contain some information supplied during a pre-production design evaluation. IXYS reserves the right to change limits, test conditions, and dimensions without notice.

### TO-268 Outline

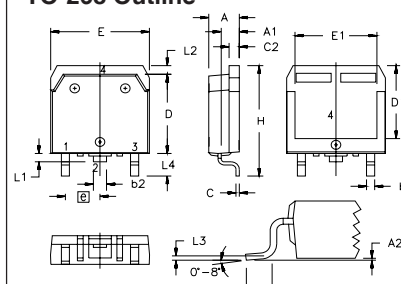

Terminals: 1 - Gate, 2,4 - Collector, 3 - Emitter

SYM	INCHES		MILLIMETERS	
	MIN	MAX	MIN	MAX
A	.193	.201	4.90	5.10
A1	.106	.114	2.70	2.90
A2	.001	.010	0.02	0.25
b	.045	.057	1.15	1.45
b2	.075	.083	1.90	2.10
C	.016	.026	0.40	0.65
C2	.057	.063	1.45	1.60
D	.543	.551	13.80	14.00
D1	.488	.500	12.40	12.70
E	.624	.632	15.85	16.05
E1	.524	.535	13.30	13.60
e	.215 BSC		5.45 BSC	
H	.736	.752	18.70	19.10
L	.094	.106	2.40	2.70
L1	.047	.055	1.20	1.40
L2	.039	.045	1.00	1.15
L3	.010 BSC		0.25 BSC	
L4	.150	.161	3.80	4.10

### TO-247 Outline

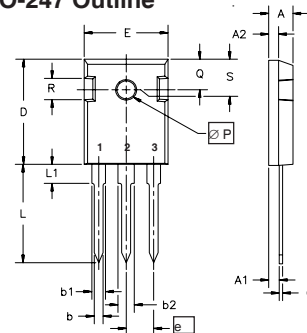

Terminals: 1 - Gate, 2 - Collector, 3 - Emitter

Dim.	Millimeter		Inches	
	Min.	Max.	Min.	Max.
A	4.7	5.3	.185	.209
A <sub>1</sub>	2.2	2.54	.087	.102
A <sub>2</sub>	2.2	2.6	.059	.098
b	1.0	1.4	.040	.055
b <sub>1</sub>	1.65	2.13	.065	.084
b <sub>2</sub>	2.87	3.12	.113	.123
C	.4	.8	.016	.031
D	20.80	21.46	.819	.845
E	15.75	16.26	.610	.640
e	5.20	5.72	0.205	0.225
L	19.81	20.32	.780	.800
L1		4.50		.177
∅P	3.55	3.65	.140	.144
Q	5.89	6.40	0.232	0.252
R	4.32	5.49	.170	.216
S	6.15	BSC	242	BSC

IXYS Reserves the Right to Change Limits, Test Conditions and Dimensions.

IXYS MOSFETs and IGBTs are covered by one or more of the following U.S. patents:

4,835,592	4,931,844	5,049,961	5,237,481	6,162,665	6,404,065 B1	6,683,344	6,727,585	7,005,734 B2	7,157,338B2
4,860,072	5,017,508	5,063,307	5,381,025	6,259,123 B1	6,534,343	6,710,405 B2	6,759,692	7,063,975 B2	
4,881,106	5,034,796	5,187,117	5,486,715	6,306,728 B1	6,583,505	6,710,463	6,771,478 B2	7,071,537	

**Fig. 1. Output Characteristics @  $T_J = 25^\circ\text{C}$**

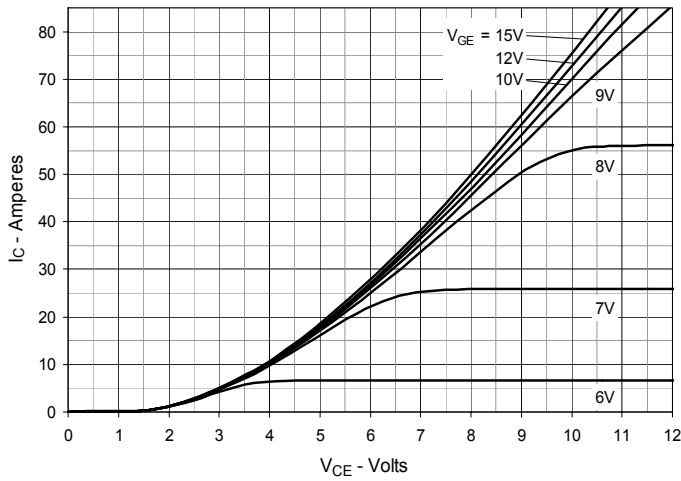

**Fig. 2. Extended Output Characteristics @  $T_J = 25^\circ\text{C}$**

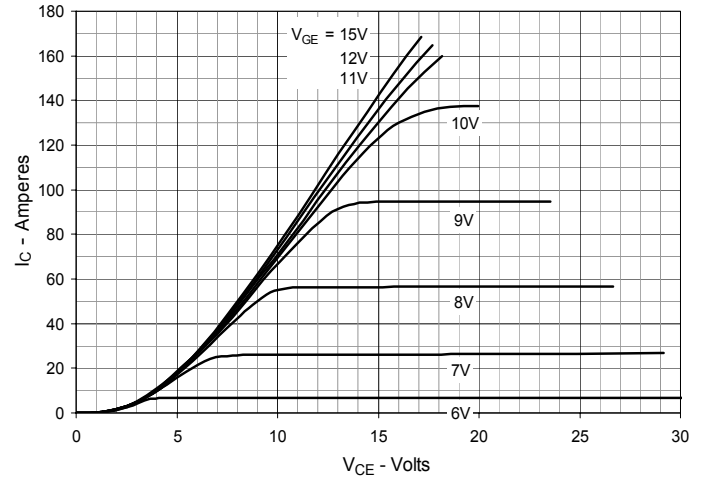

**Fig. 3. Output Characteristics @  $T_J = 125^\circ\text{C}$**

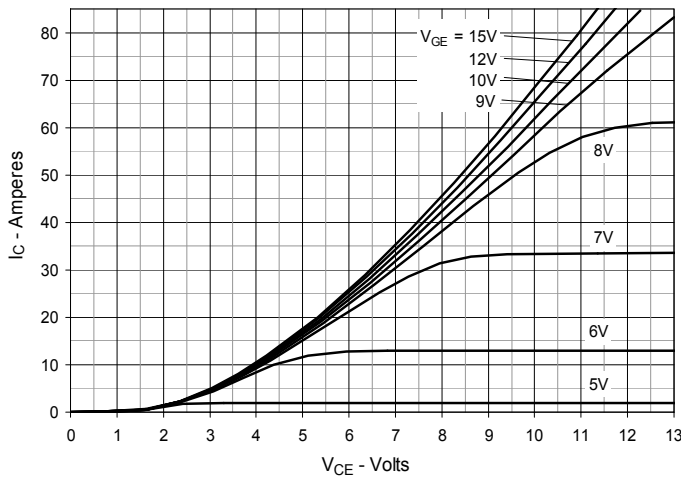

**Fig. 4. Dependence of  $V_{CE(sat)}$  on Junction Temperature**

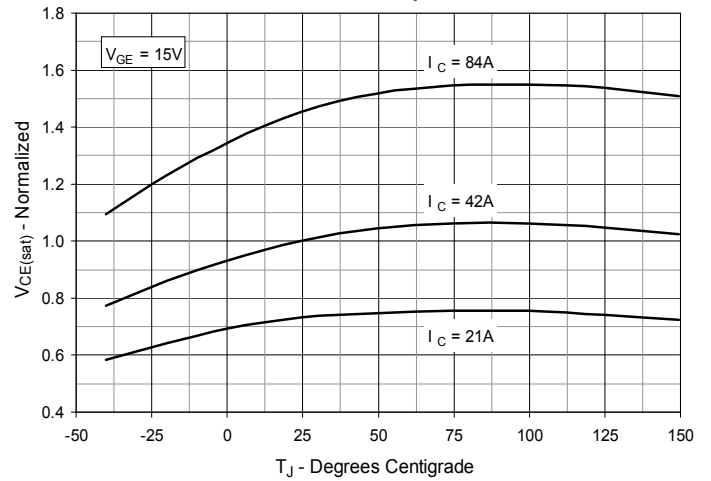

**Fig. 5. Collector-to-Emitter Voltage vs. Gate-to-Emitter Voltage**

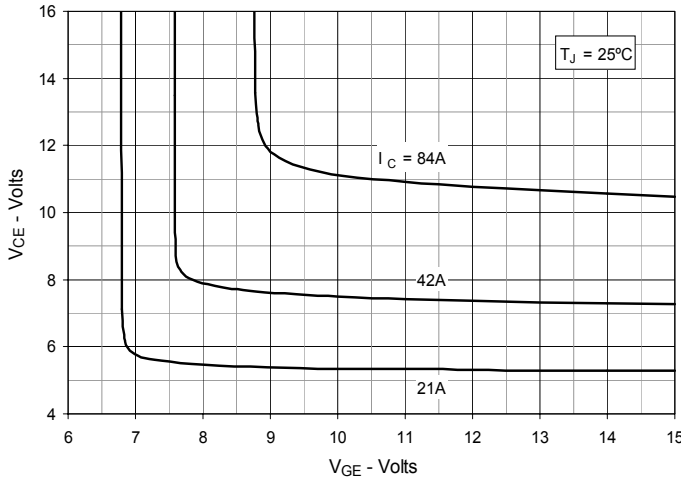

**Fig. 6. Input Admittance**

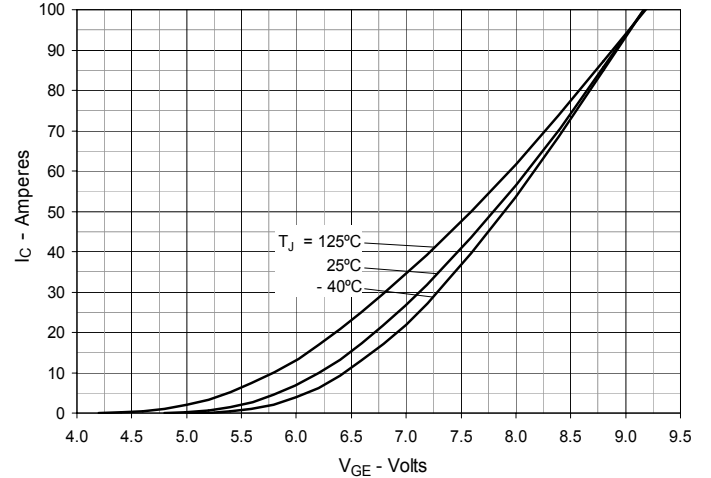

Fig. 7. Transconductance

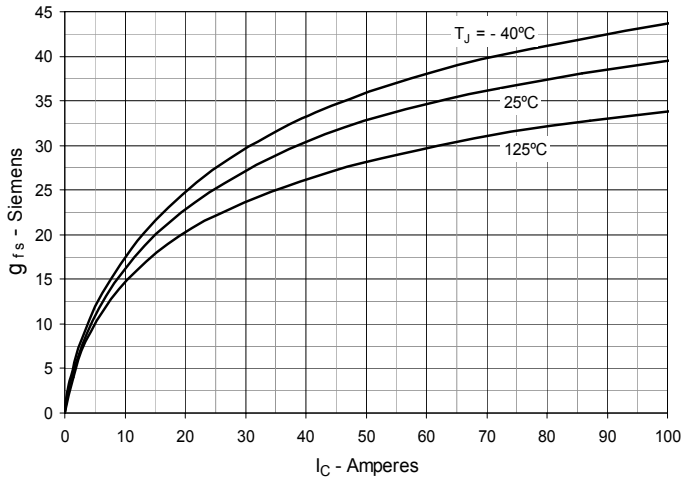

Fig. 8. Gate Charge

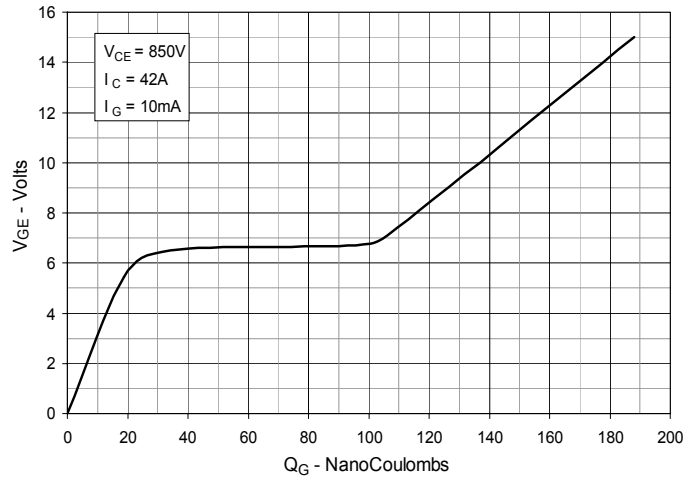

Fig. 9. Forward Voltage Drop of Intrinsic Diode

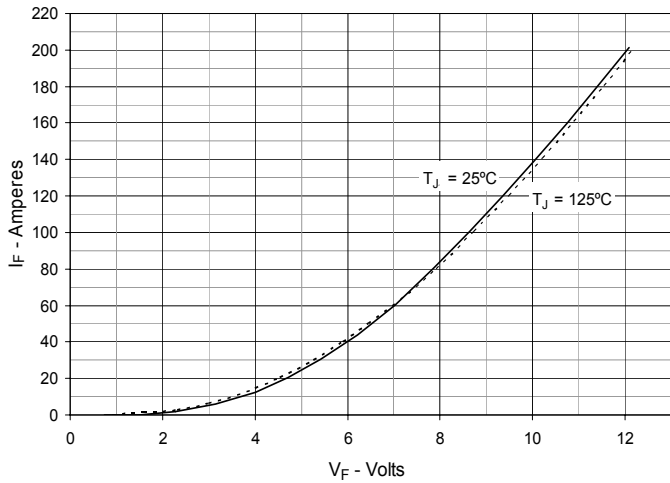

Fig. 10. Capacitance

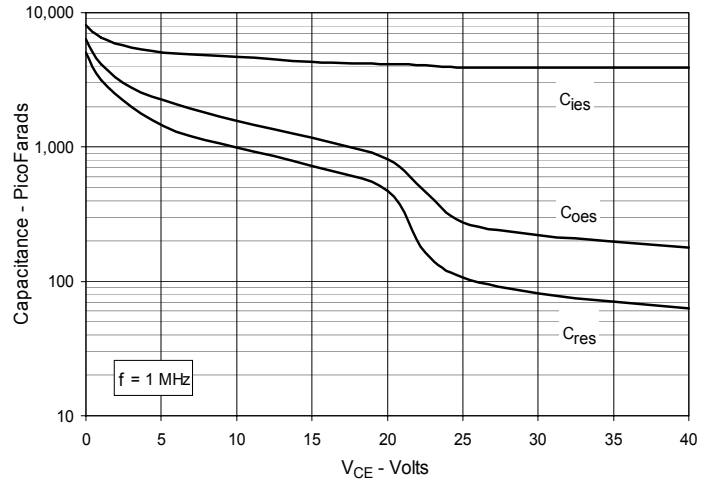

Fig. 11. Reverse-Bias Safe Operating Area

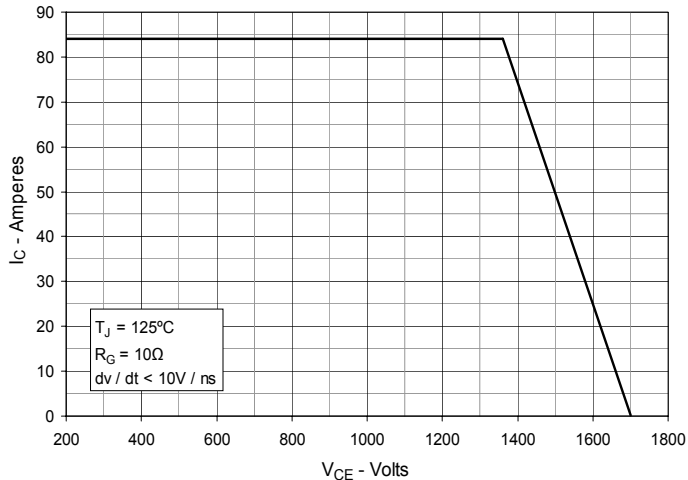

Fig. 12. Maximum Transient Thermal Impedance

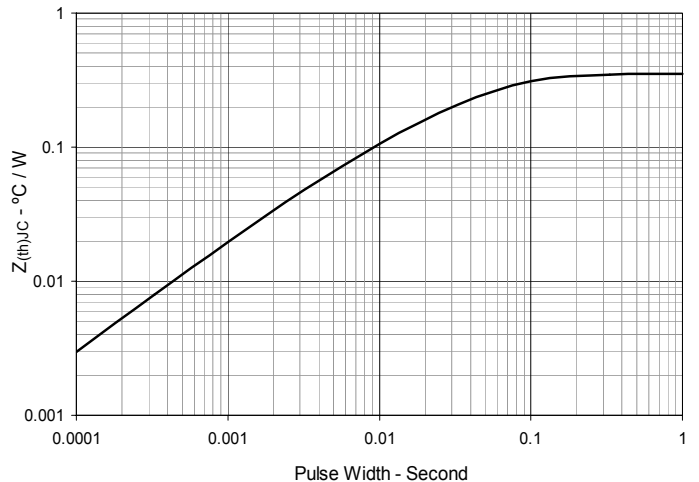

Fig. 13. Forward-Bias Safe Operating Area @  $T_C = 25^\circ\text{C}$

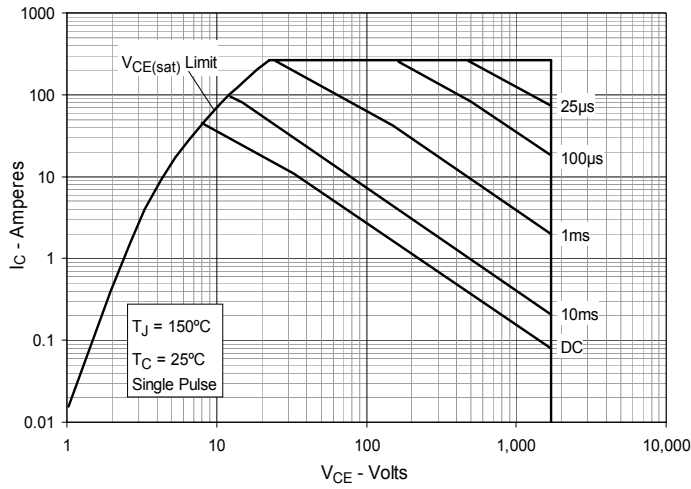

Fig. 14. Forward-Bias Safe Operating Area @  $T_C = 75^\circ\text{C}$

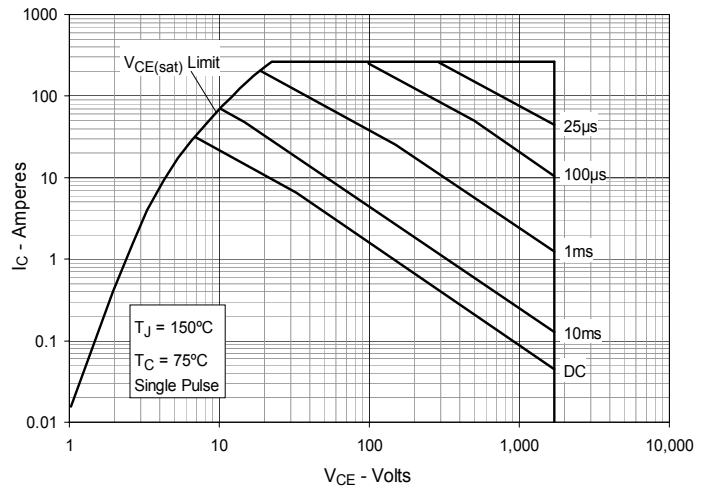

Fig. 15. Inductive Switching Energy Loss vs. Gate Resistance

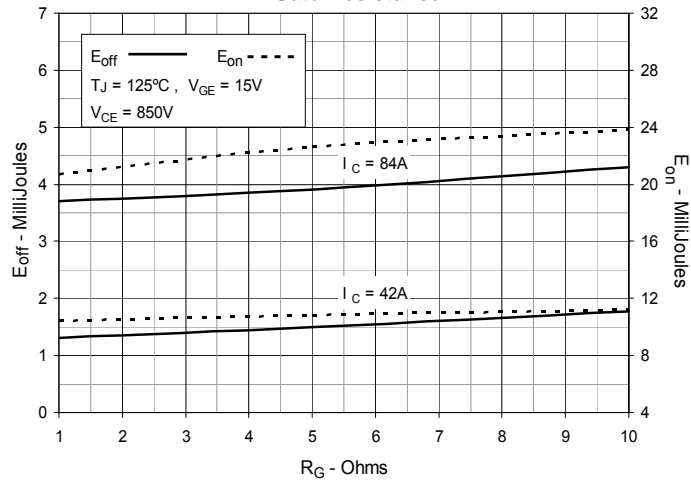

Fig. 16. Inductive Switching Energy Loss vs. Collector Current

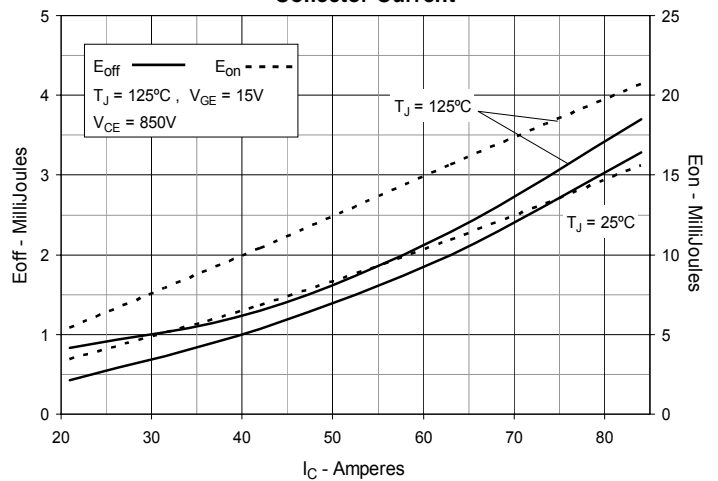

Fig. 17. Inductive Switching Energy Loss vs. Junction Temperature

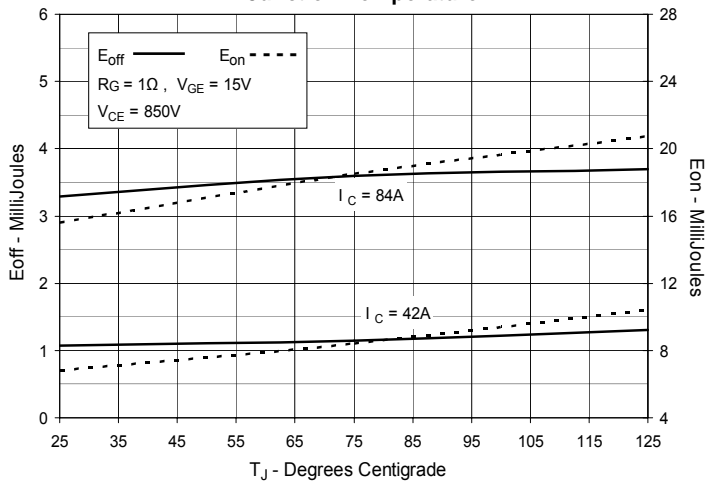
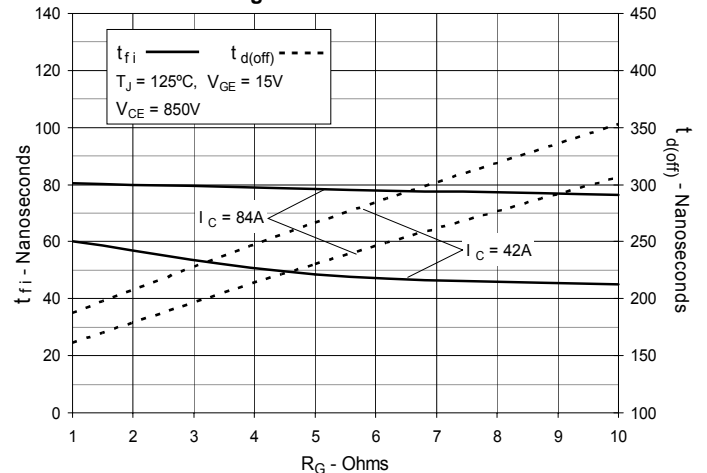
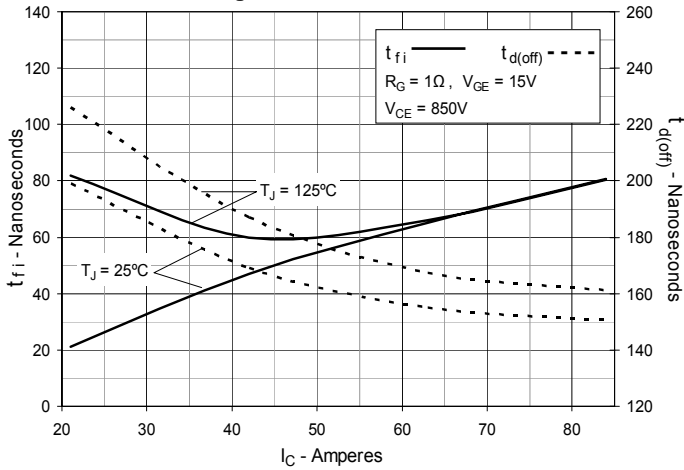

Fig. 18. Inductive Turn-off Switching Times vs. Gate Resistance



**Fig. 19. Inductive Turn-off  
Switching Times vs. Collector Current**



**Fig. 20. Inductive Turn-off  
Switching Times vs. Junction Temperature**

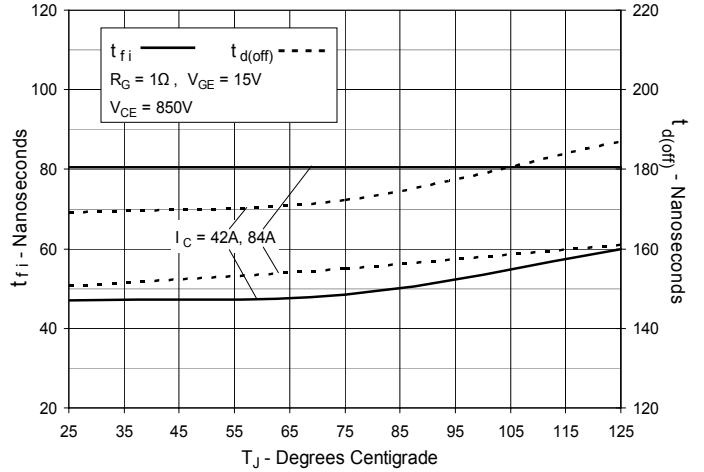

**Fig. 21. Inductive Turn-on Switching Times  
vs. Gate Resistance**

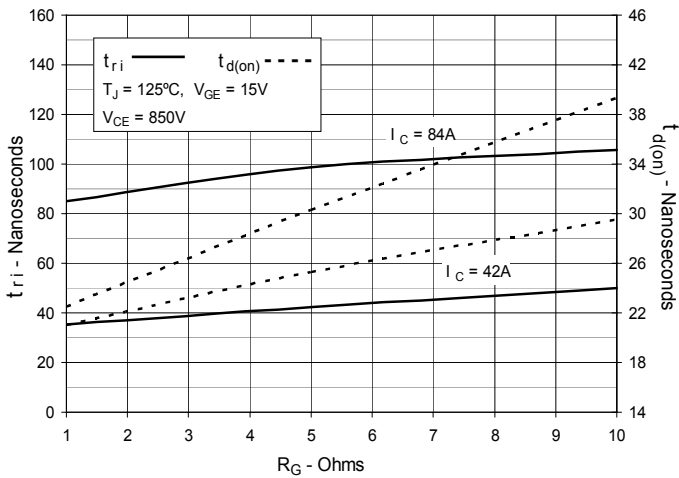

**Fig. 22. Inductive Turn-on Switching Times  
vs. Collector Current**

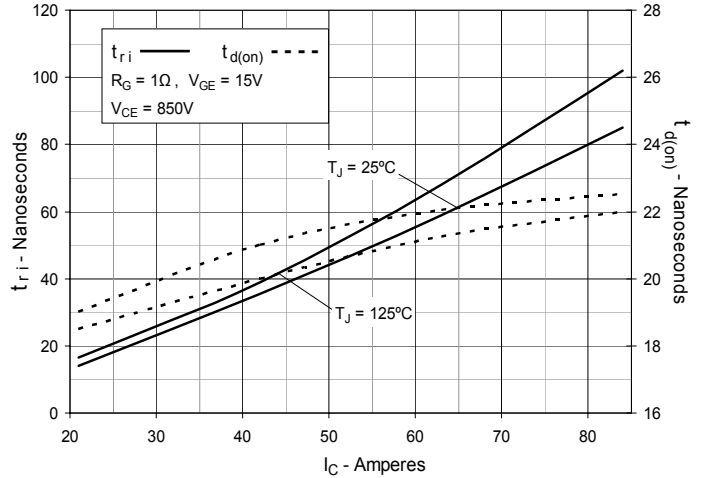

**Fig. 23. Inductive Turn-on  
Switching Times vs. Junction Temperature**

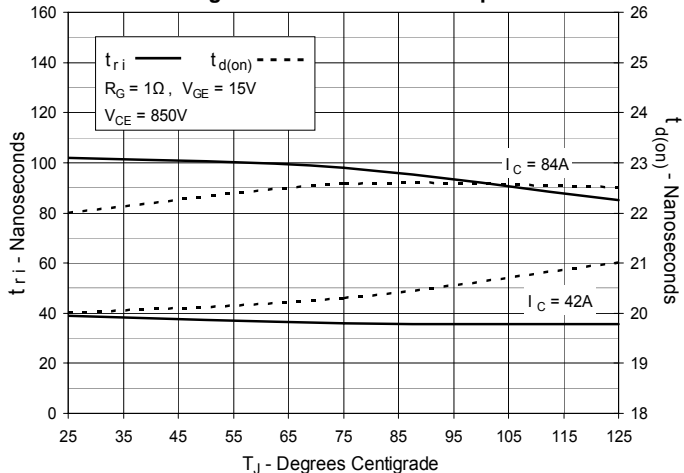



---

Disclaimer Notice - Information furnished is believed to be accurate and reliable. However, users should independently evaluate the suitability of and test each product selected for their own applications. Littelfuse products are not designed for, and may not be used in, all applications. Read complete Disclaimer Notice at [www.littelfuse.com/disclaimer-electronics](http://www.littelfuse.com/disclaimer-electronics).