

Rectifier Diode

Type W3697V#160 to W3697V#280

Old Type No.: SW02-20CXC16C

Absolute Maximum Ratings

	VOLTAGE RATINGS	MAXIMUM LIMITS	UNITS
V_{RRM}	Repetitive peak reverse voltage, (note 1)	1600-2800	V
V_{RSM}	Non-repetitive peak reverse voltage, (note 1)	1700-2900	V

	OTHER RATINGS	MAXIMUM LIMITS	UNITS
$I_{F(AV)M}$	Maximum average forward current, $T_{sink}=55^{\circ}C$, (note 2)	3697	A
$I_{F(AV)M}$	Maximum average forward current. $T_{sink}=100^{\circ}C$, (note 2)	2530	A
$I_{F(AV)M}$	Maximum average forward current. $T_{sink}=100^{\circ}C$, (note 3)	1520	A
$I_{F(RMS)M}$	Nominal RMS forward current, $T_{sink}=25^{\circ}C$, (note 2)	6840	A
$I_{F(d.c.)}$	D.C. forward current, $T_{sink}=25^{\circ}C$, (note 4)	5840	A
I_{FSM}	Peak non-repetitive surge $t_p=10ms$, $V_m=0.6V_{RRM}$, (note 5)	40	kA
I_{FSM2}	Peak non-repetitive surge $t_p=10ms$, $V_m \leq 10V$, (note 5)	45	kA
I^2t	I^2t capacity for fusing $t_p=10ms$, $V_m=0.6V_{RRM}$, (note 5)	8.0×10^6	A^2s
I^2t	I^2t capacity for fusing $t_p=10ms$, $V_m \leq 10V$, (note 5)	10.1×10^6	A^2s
$T_{j op}$	Operating temperature range	-55 to +160	$^{\circ}C$
T_{stg}	Storage temperature range	-55 to +180	$^{\circ}C$

Notes:-

- 1) De-rating factor of 0.13% per $^{\circ}C$ is applicable for T_j below $25^{\circ}C$.
- 2) Double side cooled, single phase; 50Hz, 180° half-sinewave.
- 3) Single side cooled, single phase; 50Hz, 180° half-sinewave.
- 4) Double side cooled.
- 5) Half-sinewave, $160^{\circ}C$ T_j initial.

Characteristics

	PARAMETER	MIN.	TYP.	MAX.	TEST CONDITIONS (Note 1)	UNITS
V _{FM}	Maximum peak forward voltage	-	-	1.54	I _{TM} =6800A	V
V _{FM}	Maximum peak forward voltage	-	-	1.95	I _{TM} =11100A	V
V _{T0}	Threshold voltage	-	-	0.86		V
r _T	Slope resistance	-	-	0.10		mΩ
I _{RRM}	Peak reverse current	-	-	60	Rated V _{RRM}	mA
I _{RRM}	Peak reverse current	-	-	60	Rated V _{RRM} , T _j =25°C	mA
R _{thJK}	Thermal resistance, junction to heatsink	-	-	0.016	Double side cooled	K/W
		-	-	0.032	Single side cooled	K/W
F	Mounting force	27	-	34		kN
W _t	Weight	-	800	-	Outline Options VF	g
		-	1000	-	Outline Options VC, VT	g

Notes:-

- 1) Unless otherwise indicated T_j=160°C.
- 2) For other clamp forces, please consult factory.

Notes on rupture rated packages.

This product is available with a non-rupture rated package.
For additional details on these products, please consult factory.

Notes on Ratings and Characteristics

1.0 Voltage Grade Table

Voltage Grade	V_{DRM} V_{DSM} V_{RRM} V	V_{RSM} V	V_D V_R DC V
16	1600	1700	1050
18	1800	1900	1150
20	2000	2100	1250
22	2200	2300	1350
24	2400	2500	1450
26	2600	2700	1550
28	2800	2900	1600

2.0 Extension of Voltage Grades

This report is applicable to other voltage grades when supply has been agreed by Sales/Production.

3.0 De-rating Factor

A blocking voltage de-rating factor of 0.13%/°C is applicable to this device for T_j below 25°C.

4.0 Snubber Components

When selecting snubber components, care must be taken not to use excessively large values of snubber capacitor or excessively small values of snubber resistor. Such excessive component values may lead to device damage due to the large resultant values of snubber discharge current. If required, please consult the factory for assistance.

5.0 Computer Modelling Parameters

5.1 Device Dissipation Calculations

$$I_{AV} = \frac{-V_0 + \sqrt{V_0^2 + 4 \cdot ff^2 \cdot r_s \cdot W_{AV}}}{2 \cdot ff^2 \cdot r_s} \quad \text{and:} \quad W_{AV} = \frac{\Delta T}{R_{th}}$$

$$\Delta T = T_{j\max} - T_{Hs}$$

Where $V_0=0.86V$, $r_s=0.1m\Omega$,

R_{th} = Supplementary thermal impedance, see table below and

ff = Form factor, see table below.

Supplementary Thermal Impedance				
Conduction Angle	6 phase (60°)	3 phase (120°)	½ wave (180°)	d.c.
Square wave Double Side Cooled	0.0205	0.0190	0.0170	0.0160
Square wave Single Side Cooled	0.0400	0.0376	0.0340	0.0320
Sine wave Double Side Cooled	0.0198	0.0177	0.0162	
Sine wave Single Side Cooled	0.0388	0.0355	0.0324	

Form Factors				
Conduction Angle	6 phase (60°)	3 phase (120°)	½ wave (180°)	d.c.
Square wave	2.449	1.732	1.414	1
Sine wave	2.778	1.879	1.57	

5.2 Calculating V_F using ABCD Coefficients

The on-state characteristic I_F vs. V_F , on page 6 is represented in two ways;

- (i) The well established V_0 and r_T tangent used for rating purposes and
- (ii) A set of constants A, B, C, D, forming the coefficients of the representative equation for V_F in terms of I_F given below:

$$V_F = A + B \cdot \ln(I_F) + C \cdot I_F + D \cdot \sqrt{I_F}$$

The constants, derived by curve fitting software, are given below for hot characteristics. The resulting values for V_F agree with the true device characteristic over a current range, which is limited to that plotted.

	160°C Coefficients
A	0.2946829
B	0.100011
C	1.106436×10^{-4}
D	-4.781509×10^{-3}

5.3 D.C. Thermal Impedance Calculation

$$r_t = \sum_{p=1}^{p=n} r_p \cdot \left(1 - e^{-\frac{t}{\tau_p}} \right)$$

Where $p = 1$ to n , n is the number of terms in the series and:

t = Duration of heating pulse in seconds.

r_t = Thermal resistance at time t .

r_p = Amplitude of p_{th} term.

τ_p = Time Constant of r_{th} term.

The coefficients for this device are shown in the tables below:

D.C. Double Side Cooled				
Term	1	2	3	4
r_p	6.850949×10^{-3}	6.006273×10^{-3}	1.872869×10^{-3}	1.385196×10^{-3}
τ_p	1.219991	0.1764593	0.02313936	3.319288×10^{-3}

D.C. Single Side Cooled					
Term	1	2	3	4	5
r_p	0.01803063	5.201877×10^{-3}	4.810704×10^{-3}	3.890524×10^{-3}	2.299757×10^{-3}
τ_p	9.810556	4.974419	0.3591421	0.09925002	5.541104×10^{-3}

Curves

Figure 1 - Forward characteristics of Limit device

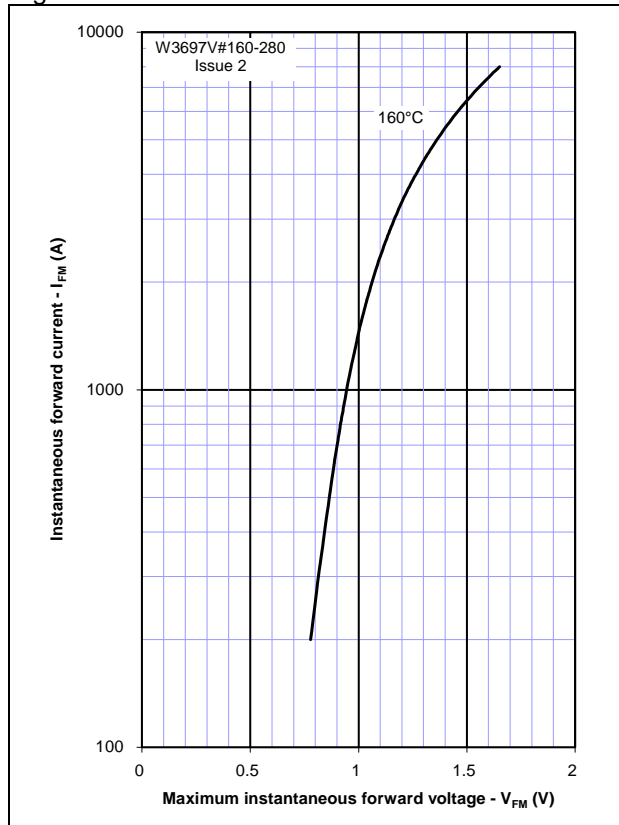

Figure 2 - Transient thermal impedance

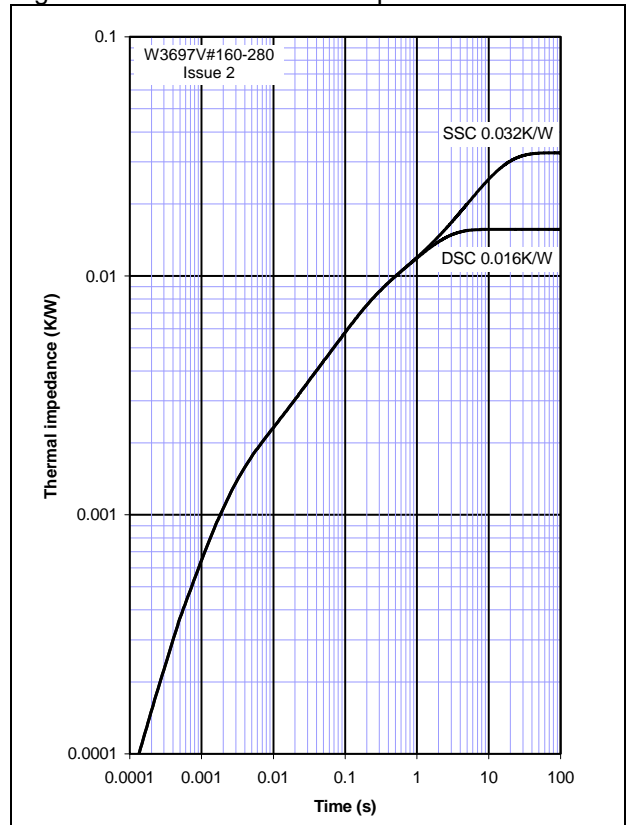

Figure 3 - Maximum surge Rating

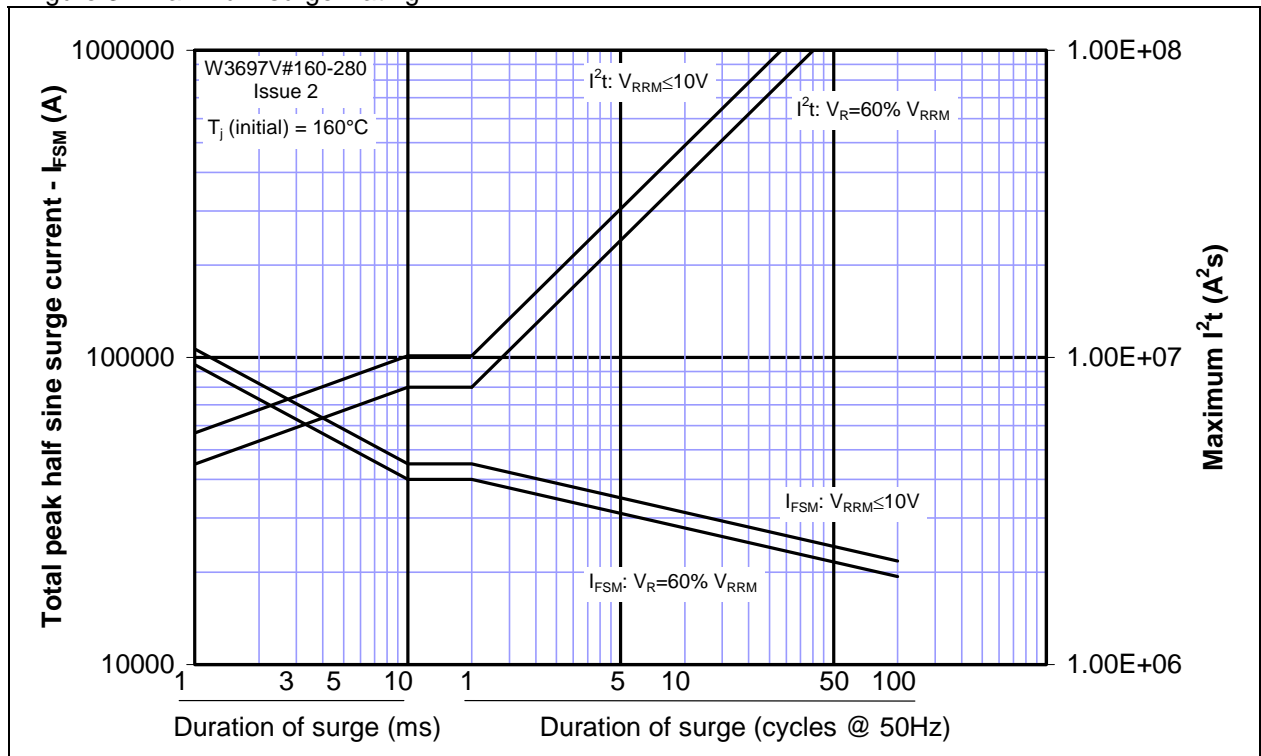

Figure 4 – Forward current vs. Power dissipation – Double Side Cooled

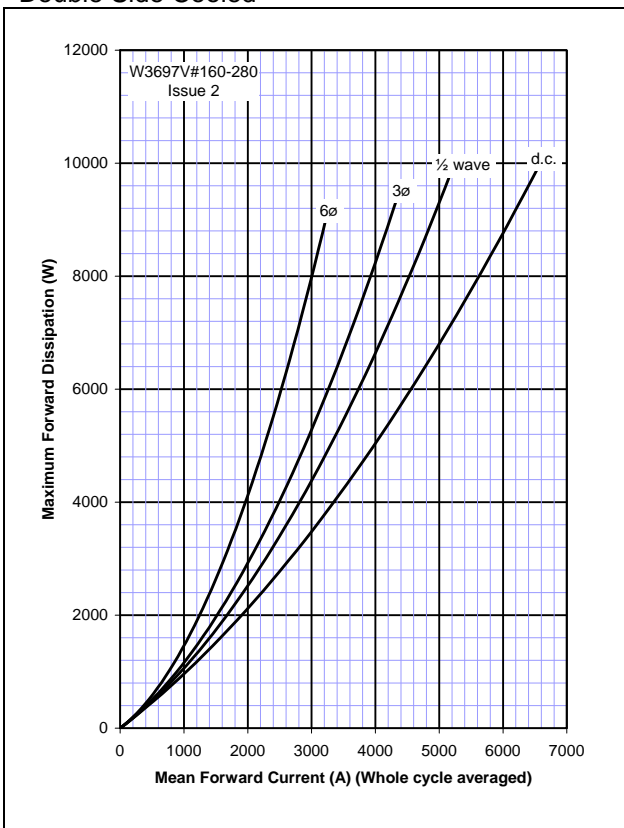

Figure 5 – Forward current vs. Heatsink temperature - Double Side Cooled

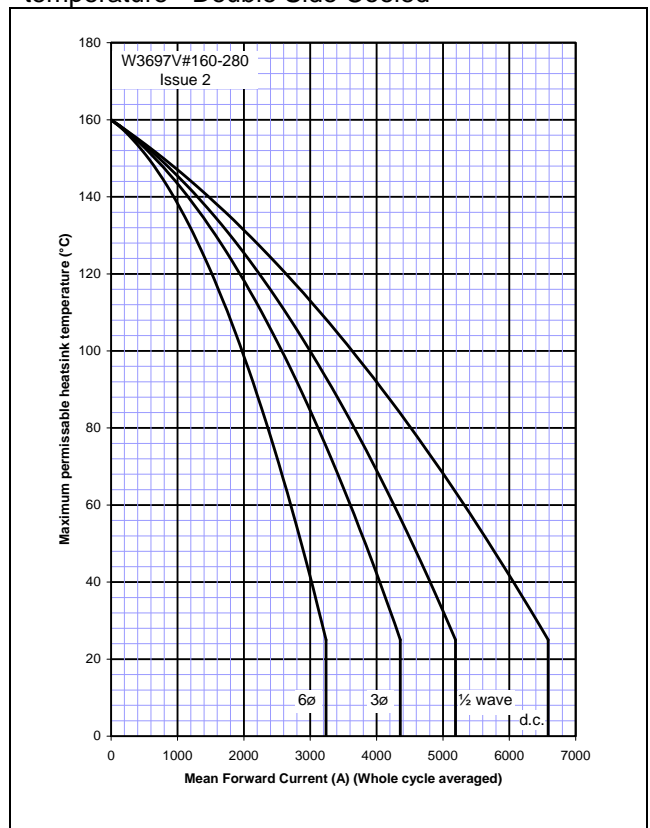

Figure 6 – Forward current vs. Power dissipation – Single Side Cooled

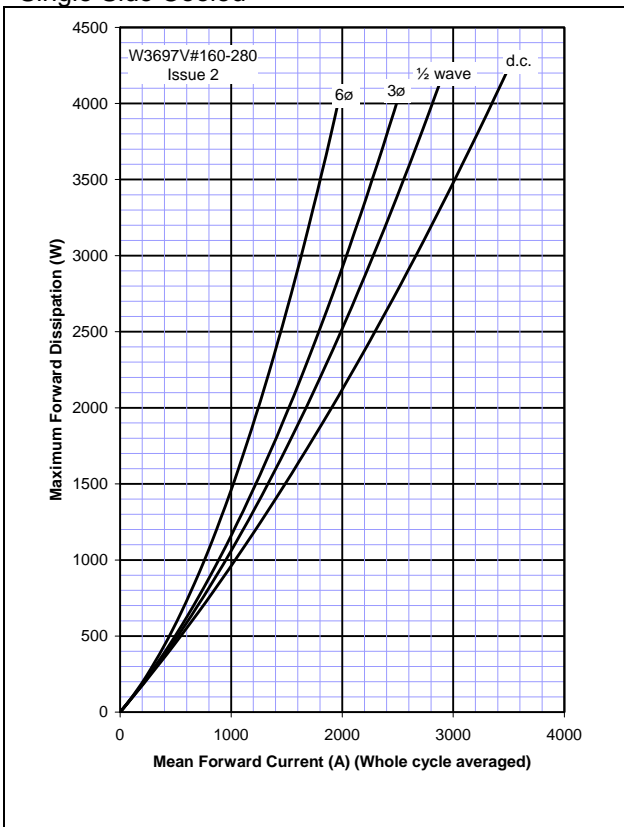
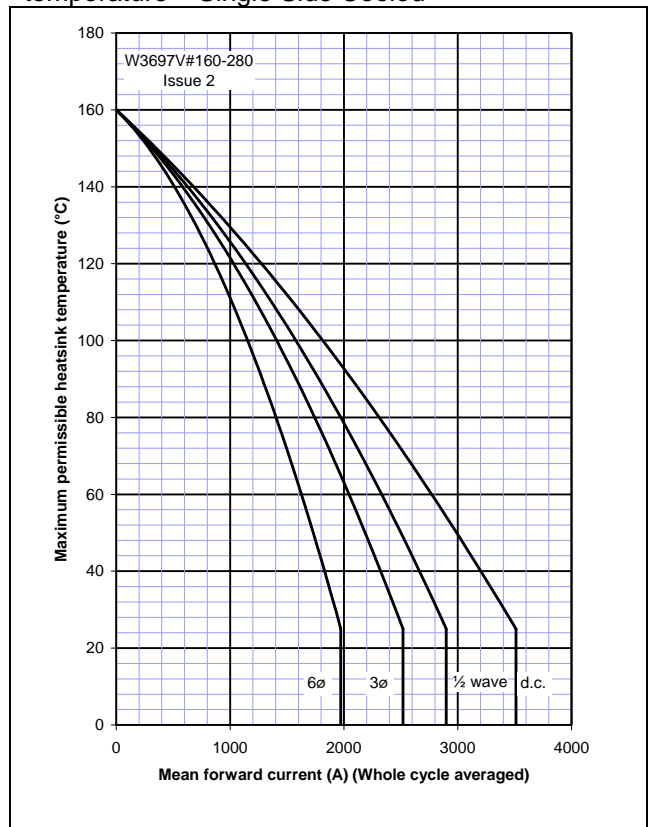
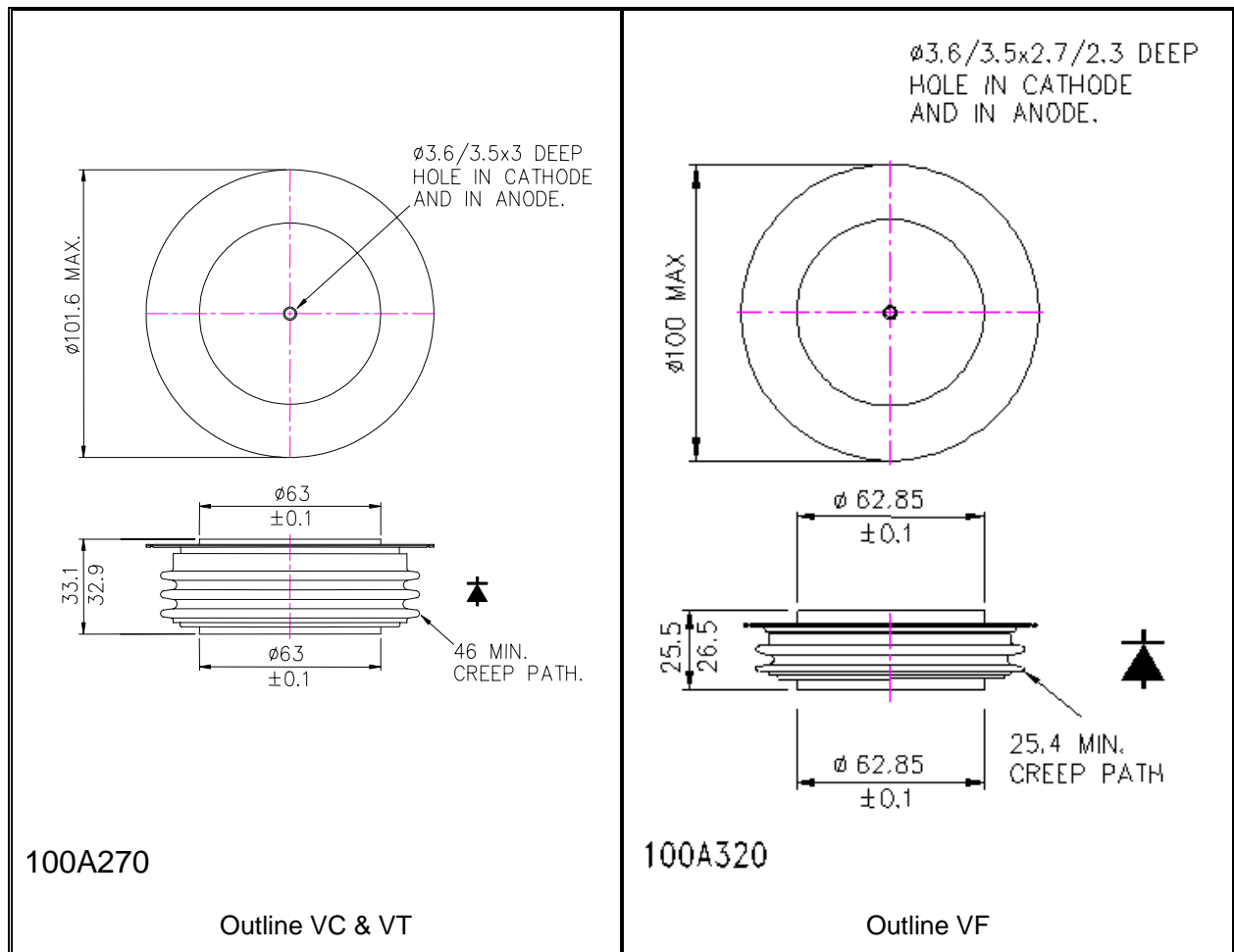

Figure 7 – Forward current vs. Heatsink temperature – Single Side Cooled



Outline Drawing & Ordering Information



ORDERING INFORMATION

(Please quote 10 digit code as below)

W3697	V#	◆◆	0
Fixed Type Code	Fixed outline code VC = 33mm Clamp height, VT = 33mm rupture rated capsule, VF = 26mm Clamp height	Voltage code V _{DRM} /100 16-28	Fixed turn-off time code

Order code: W3697VC180 – 1800V V_{RRM}, 33.1mm clamp height capsule.

IXYS Semiconductor GmbH
Edisonstraße 15
D-68623 Lampertheim
Tel: +49 6206 503-0
Fax: +49 6206 503-627
E-mail: marcom@ixys.de

WESTCODE

An IXYS Company

www.westcode.com

www.ixys.net

Westcode Semiconductors Ltd
Langley Park Way, Langley Park,
Chippenham, Wiltshire, SN15 1GE.
Tel: +44 (0)1249 444524
Fax: +44 (0)1249 659448
E-mail: WSL.sales@westcode.com

IXYS Corporation
1590 Buckeye Drive
Milpitas CA 95035 7418 USA
Tel: +1 (408) 547 9000
Fax: +1 (408) 496 0670
E-mail: sales@ixys.net

IXYS Long Beach Inc
2500 Mira Mar Avenue
Long Beach CA 90815 USA
Tel: +1 (562) 296 6584
Fax: +1 (562) 296 6585
E-mail: service@ixyslongbeach.com

The information contained herein is confidential and is protected by Copyright. The information may not be used or disclosed except with the written permission of and in the manner permitted by the proprietors Westcode Semiconductors Ltd.

© Westcode Semiconductors Ltd.

In the interest of product improvement, Westcode reserves the right to change specifications at any time without prior notice.

Devices with a suffix code (2-letter, 3-letter or letter/digit/letter combination) added to their generic code are not necessarily subject to the conditions and limits contained in this report.



Disclaimer Notice - Information furnished is believed to be accurate and reliable. However, users should independently evaluate the suitability of and test each product selected for their own applications. Littelfuse products are not designed for, and may not be used in, all applications. Read complete Disclaimer Notice at www.littelfuse.com/disclaimer-electronics.