

## Fast Recovery Diode Types M0588LC400 to M0588LC450

### Absolute Maximum Ratings

|           | VOLTAGE RATINGS                               | MAXIMUM LIMITS | UNITS |
|-----------|---|----------------|-------|
| $V_{RRM}$ | Repetitive peak reverse voltage, (note 1)     | 4000-4500      | V     |
| $V_{RSM}$ | Non-repetitive peak reverse voltage, (note 1) | 4100-4600      | V     |

|               | OTHER RATINGS (note 6)   | MAXIMUM LIMITS    | UNITS       |
|---------------|--|-------------------|-------------|
| $I_{F(AV)}$   | Mean forward current, $T_{sink}=55^{\circ}C$ , (note 2)                | 588               | A           |
| $I_{F(AV)}$   | Mean forward current. $T_{sink}=100^{\circ}C$ , (note 2)               | 389               | A           |
| $I_{F(AV)}$   | Mean forward current. $T_{sink}=100^{\circ}C$ , (note 3)               | 237               | A           |
| $I_{F(RMS)}$  | Nominal RMS forward current, $T_{sink}=25^{\circ}C$ , (note 2)         | 1108              | A           |
| $I_{F(d.c.)}$ | D.C. forward current, $T_{sink}=25^{\circ}C$ , (note 4)                | 969               | A           |
| $I_{FSM}$     | Peak non-repetitive surge $t_p=10ms$ , $V_{RM}=0.6V_{RRM}$ , (note 5)  | 3955              | A           |
| $I_{FSM2}$    | Peak non-repetitive surge $t_p=10ms$ , $V_{RM}\leq 10V$ , (note 5)     | 4350              | A           |
| $I^2t$        | $I^2t$ capacity for fusing $t_p=10ms$ , $V_{RM}=0.6V_{RRM}$ , (note 5) | $78.2\times 10^3$ | $A^2s$      |
| $I^2t$        | $I^2t$ capacity for fusing $t_p=10ms$ , $V_{RM}\leq 10V$ , (note 5)    | $94.6\times 10^3$ | $A^2s$      |
| $T_{HS}$      | Operating temperature range  | -40 to +150       | $^{\circ}C$ |
| $T_{stg}$     | Storage temperature range  | -40 to +150       | $^{\circ}C$ |

#### Notes:-

- 1) De-rating factor of 0.13% per  $^{\circ}C$  is applicable for  $T_j$  below  $25^{\circ}C$ .
- 2) Double side cooled, single phase; 50Hz,  $180^{\circ}$  half-sinewave.
- 3) Single side cooled, single phase; 50Hz,  $180^{\circ}$  half-sinewave.
- 4) Double side cooled.
- 5) Half-sinewave,  $150^{\circ}C$   $T_j$  initial.

**Characteristics**

|                | PARAMETER                                | MIN. | TYP. | MAX.  | TEST CONDITIONS (Note 1)                        | UNITS      |
|----------------|--|------|------|-------|---|------------|
| $V_{FM}$       | Maximum peak forward voltage             | -    | -    | 4.8   | $I_{FM}=1400A$                                  | V          |
| $V_0$          | Threshold voltage                        | -    | -    | 2.32  |   | V          |
| $r_s$          | Slope resistance                         | -    | -    | 1.77  |   | m $\Omega$ |
| $V_{FRM}$      | Maximum forward recovery voltage         | -    | -    | 140   | $di/dt = 1000A/\mu s$                           | V          |
|                |  | -    | -    | 85    | $di/dt = 1000A/\mu s, T_j=25^\circ C$           |            |
| $I_{RRM}$      | Peak reverse current                     | -    | -    | 100   | Rated $V_{RRM}$                                 | mA         |
| $Q_{rr}$       | Reverse Recovery Charge                  | -    | 450  | -     |   | $\mu C$    |
| $Q_{ra}$       | Recovered charge, 50% Chord              | -    | 200  | 300   | $I_{FM}=1000A, t_p=1000\mu s, di/dt=60A/\mu s,$ | $\mu C$    |
| $I_{rm}$       | Reverse Recovery Current                 | -    | 100  | -     | $V_r=50V, 50\% \text{ Chord.}$                  | A          |
| $t_{rr}$       | Reverse recovery time, 50% Chord         | -    | 3.5  | -     |   | $\mu s$    |
| $R_{th(j-hs)}$ | Thermal resistance, junction to heatsink | -    | -    | 0.033 | Double side cooled                              | K/W        |
|                |  | -    | -    | 0.066 | Single side cooled                              |            |
| F              | Mounting force                           | 10   | -    | 20    |   | kN         |
| $W_t$          | Weight                                   | -    | 340  | -     |   | g          |

Notes:-

1) Unless otherwise indicated  $T_j=150^\circ C$ .**Introduction**

The M0588LC400-450 fast recovery diode range has controlled reverse recovery characteristics.

Devices with a suffix code (2 letter or letter/digit/letter combination) added to their generic code are not necessarily subject to the conditions and limits contained in this report.

## Notes on Ratings and Characteristics

### 1.0 Voltage Grade Table

| Voltage Grade | $V_{RRM}$<br>(V) | $V_{RSM}$<br>(V) | $V_R$ dc<br>(V) |
|---------------|------------------|------------------|-----------------|
| 40            | 4000             | 4100             | 2000            |
| 42            | 4200             | 4300             | 2040            |
| 44            | 4400             | 4500             | 2080            |
| 45            | 4500             | 4600             | 2100            |

### 2.0 De-rating Factor

A blocking voltage de-rating factor of 0.13% per °C is applicable to this device for  $T_j$  below 25°C.

### 3.0 ABCD Constants

These constants (applicable only over current range of  $V_F$  characteristic in Figure 1) are the coefficients of the expression for the forward characteristic given below:

$$V_F = A + B \cdot \ln(I_F) + C \cdot I_F + D \cdot \sqrt{I_F}$$

where  $I_F$  = instantaneous forward current.

### 4.0 Reverse recovery ratings

- (i)  $Q_{ra}$  is based on 50%  $I_{rm}$  chord as shown in Fig.(a) below.

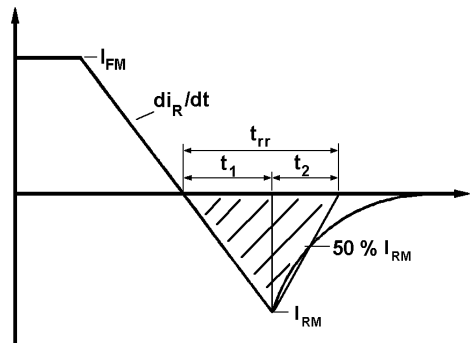

- (ii)  $Q_{rr}$  is based on a 150 $\mu$ s integration time.

i.e.

$$Q_{rr} = \int_0^{150\mu s} i_{rr} \cdot dt$$

(iii)

$$K \text{ Factor} = \frac{t_1}{t_2}$$

## 5.0 Reverse Recovery Loss

The following procedure is recommended for use where it is necessary to include reverse recovery loss.

From waveforms of recovery current obtained from a high frequency shunt (see Note 1) and reverse voltage present during recovery, an instantaneous reverse recovery loss waveform must be constructed. Let the area under this waveform be  $E$  joules per pulse. A new sink temperature can then be evaluated from:

$$T_{SINK} = T_{J(MAX)} - E \cdot [k + f \cdot R_{th(J-Hs)}]$$

Where  $k = 0.2314$  ( $^{\circ}\text{C}/\text{W}$ )/s

$E$  = Area under reverse loss waveform per pulse in joules (W.s.)

$f$  = Rated frequency in Hz at the original sink temperature.

$R_{th(J-Hs)}$  = d.c. thermal resistance ( $^{\circ}\text{C}/\text{W}$ )

The total dissipation is now given by:

$$W_{(tot)} = W_{(original)} + E \cdot f$$

### NOTE 1 - Reverse Recovery Loss by Measurement

This device has a low reverse recovered charge and peak reverse recovery current. When measuring the charge, care must be taken to ensure that:

(a) AC coupled devices such as current transformers are not affected by prior passage of high amplitude forward current.

(b) A suitable, polarised, clipping circuit must be connected to the input of the measuring oscilloscope to avoid overloading the internal amplifiers by the relatively high amplitude forward current signal.

(c) Measurement of reverse recovery waveform should be carried out with an appropriate critically damped snubber, connected across diode anode to cathode. The formula used for the calculation of this snubber is shown below:

$$R^2 = 4 \cdot \frac{V_r}{C_s \cdot di/dt}$$

Where:  $V_r$  = Commutating source voltage

$C_s$  = Snubber capacitance

$R$  = Snubber resistance

## 6.0 Computer Modelling Parameters

### 6.1 Device Dissipation Calculations

$$I_{AV} = \frac{-V_o + \sqrt{V_o^2 + 4 \cdot ff^2 \cdot r_s \cdot W_{AV}}}{2 \cdot ff^2 \cdot r_s}$$

Where  $V_o = 2.32 \text{ V}$ ,  $r_s = 0.177 \text{ m}\Omega$

$ff$  = form factor (normally unity for fast diode applications)

$$W_{AV} = \frac{\Delta T}{R_{th}}$$

$$\Delta T = T_{j(MAX)} - T_{Hs}$$

### 6.2 Calculation of $V_F$ using ABCD Coefficients

The forward characteristic  $I_F$  Vs  $V_F$ , on Fig. 1 is represented in two ways;

- (i) the well established  $V_o$  and  $r_s$  tangent used for rating purposes and
- (ii) a set of constants A, B, C, and D forming the coefficients of the representative equation for  $V_F$  in terms of  $I_F$  given below:

$$V_F = A + B \cdot \ln(I_F) + C \cdot I_F + D \cdot \sqrt{I_F}$$

The constants, derived by curve fitting software, are given in this report for hot characteristics. The resulting values for  $V_F$  agree with the true device characteristic over a current range, which is limited to that plotted.

| 125°C Coefficients |                          |
|--------------------|--------------------------|
| A                  | 2.164756168              |
| B                  | -0.3369446               |
| C                  | $3.54133 \times 10^{-4}$ |
| D                  | 0.1224153                |

**Curves**

Figure 1 – Forward characteristics of Limit device

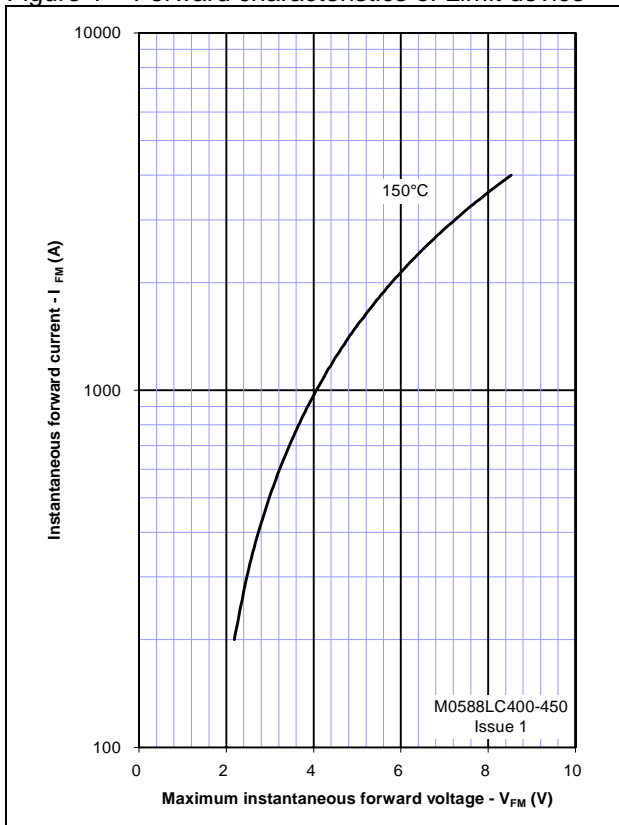

Figure 2 – Maximum forward recovery voltage

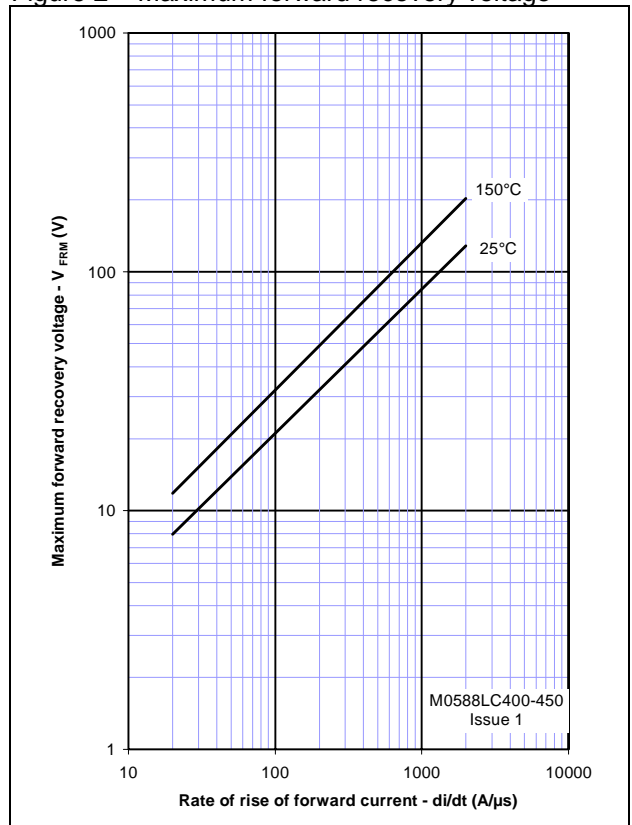

Figure 3 - Recovered charge,  $Q_{rr}$

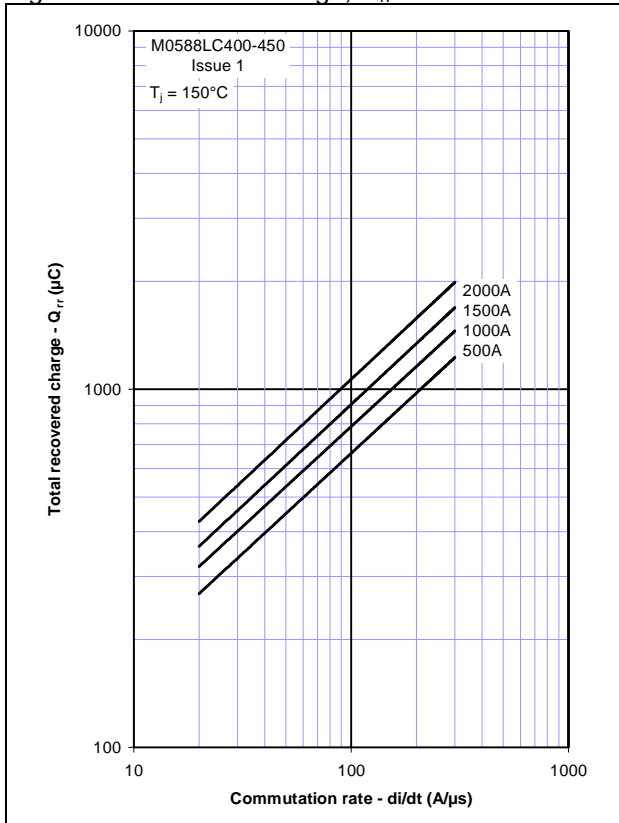

Figure 4 - Recovered charge,  $Q_{ra}$  (50% chord)

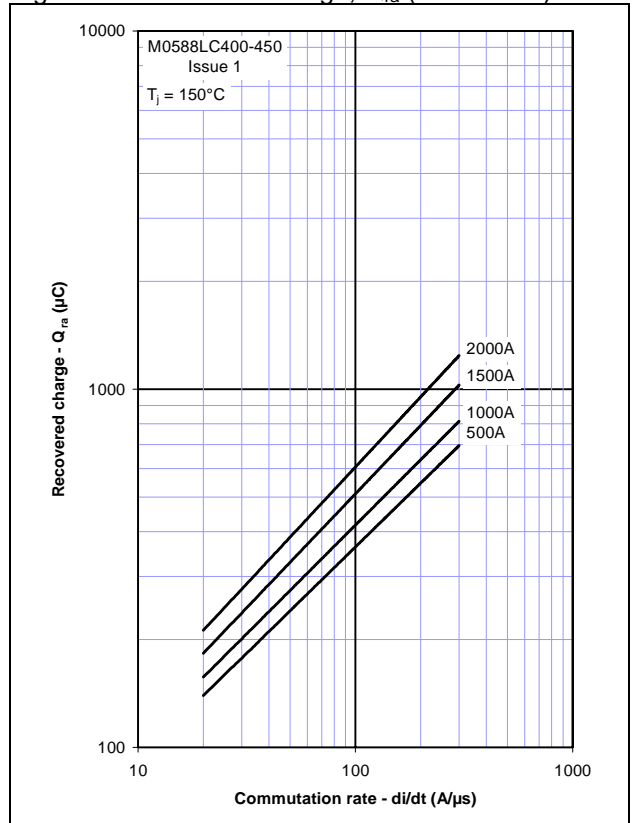

Figure 5 - Maximum reverse current,  $I_{rm}$

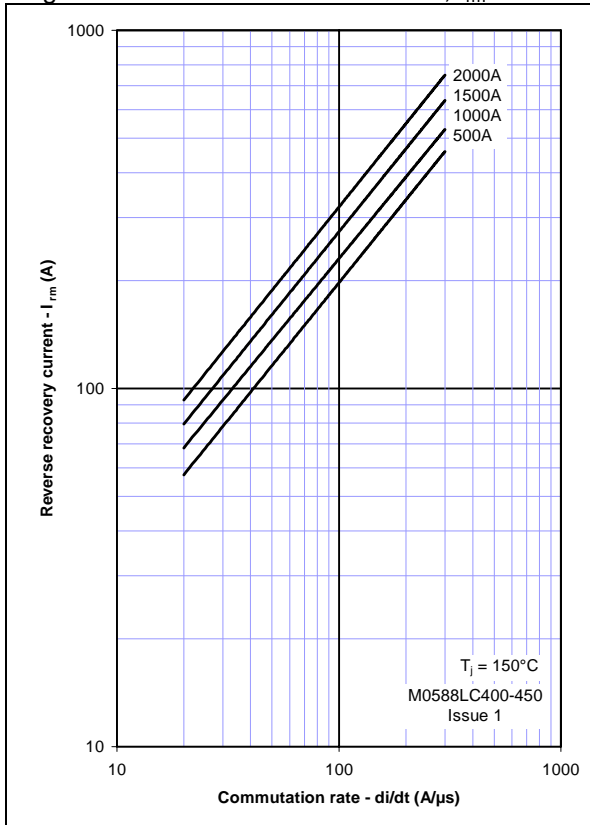

Figure 6 - Maximum recovery time,  $t_{rr}$  (50% chord)

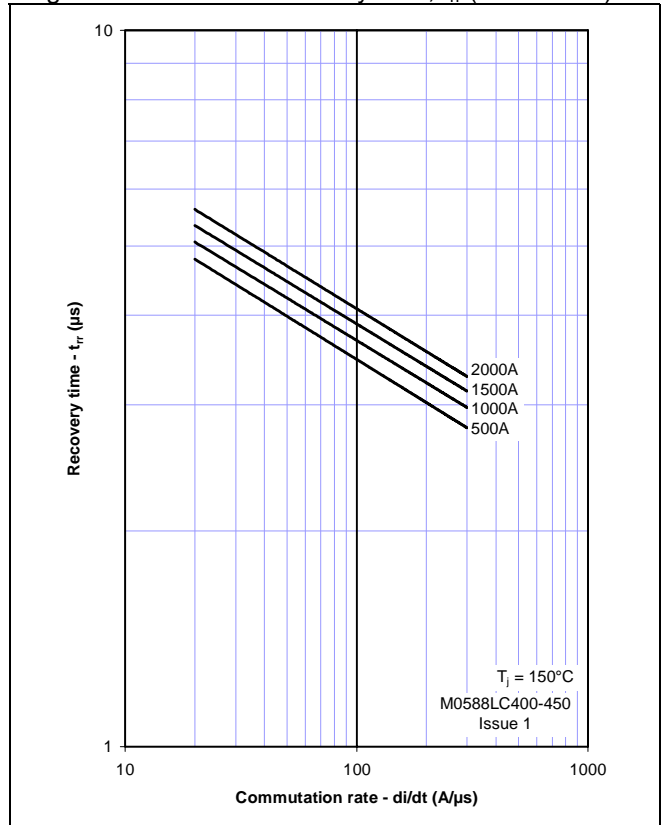

Figure 7 - Reverse recovery energy per pulse

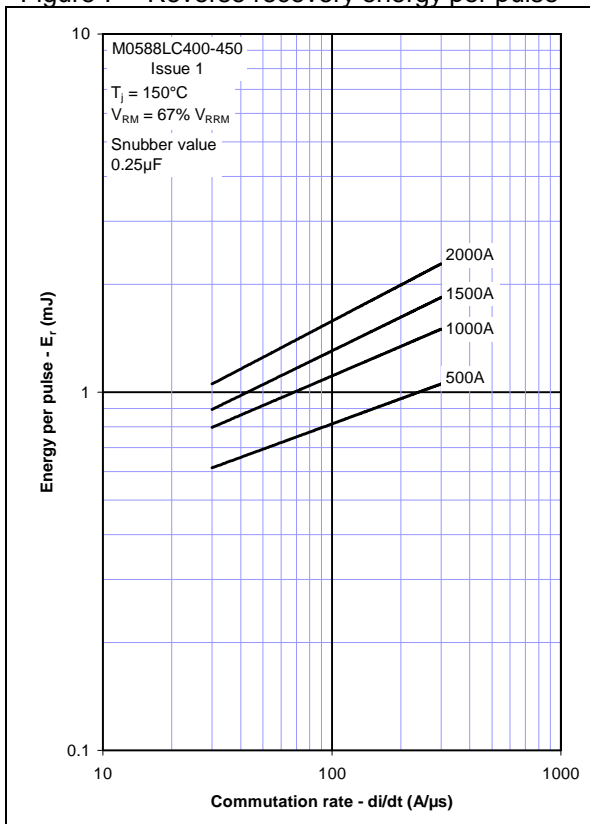

Figure 8 - Sine wave energy per pulse

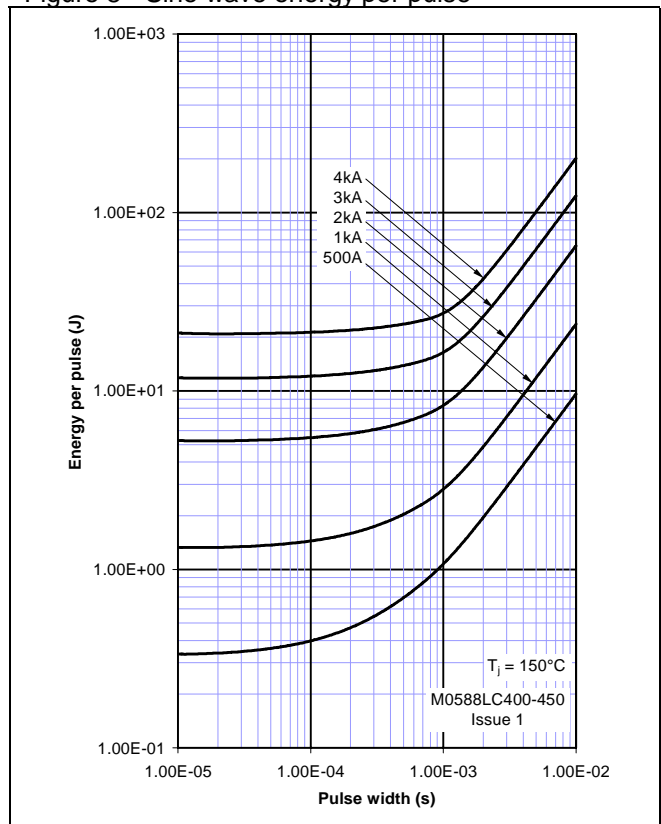

Figure 9 - Sine wave frequency vs. pulse width

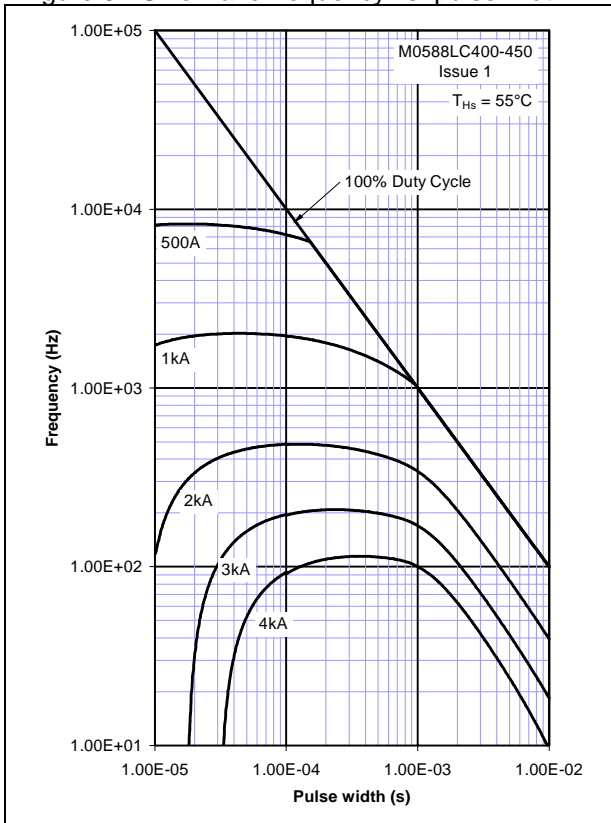

Figure 10 - Sine wave frequency vs. pulse width

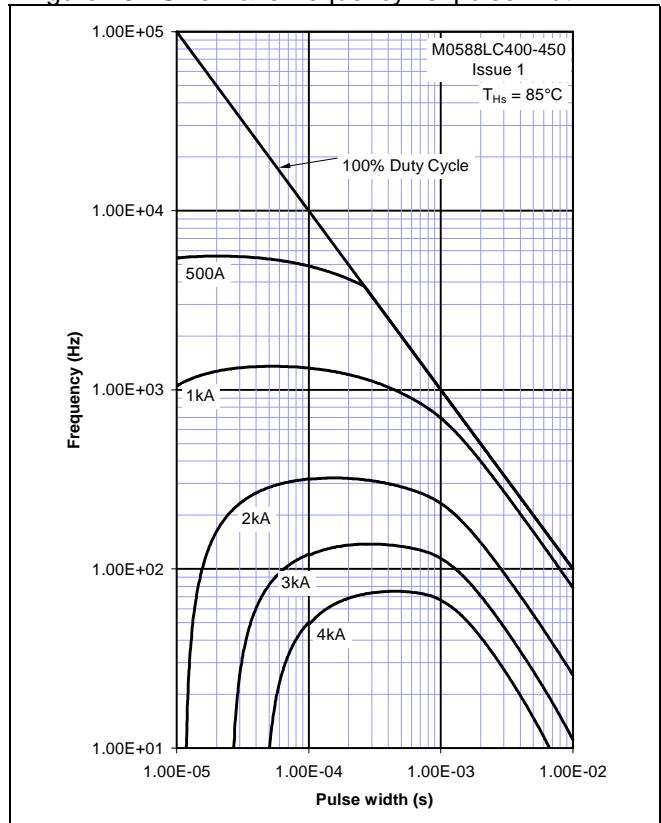

Figure 11 - Square wave frequency vs pulse width

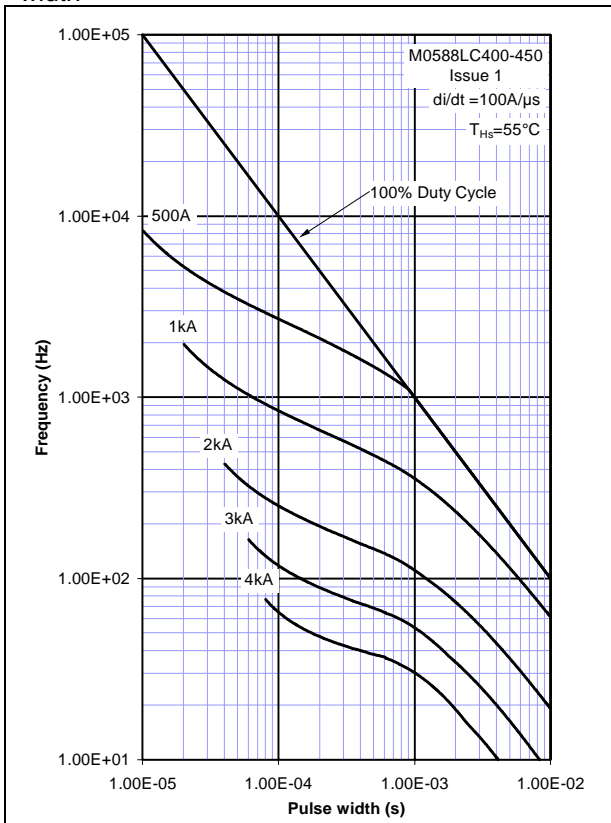

Figure 12 - Square wave frequency vs pulse width

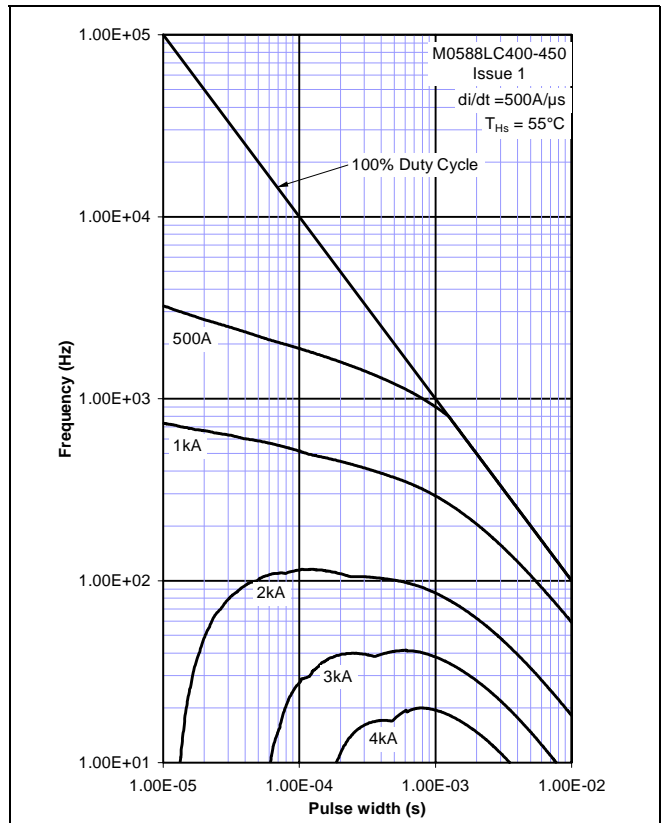



Figure 13 - Square wave frequency vs pulse width

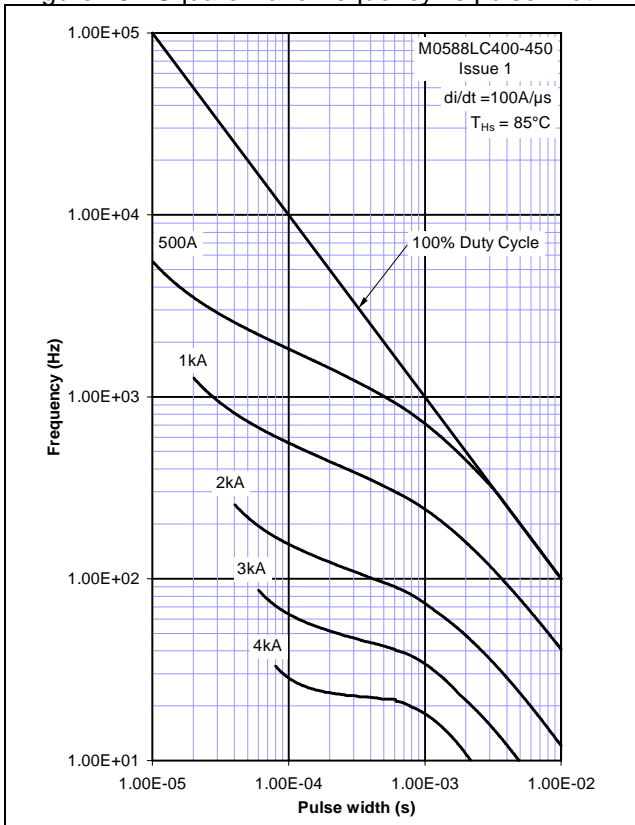

Figure 14 - Square wave frequency vs pulse width

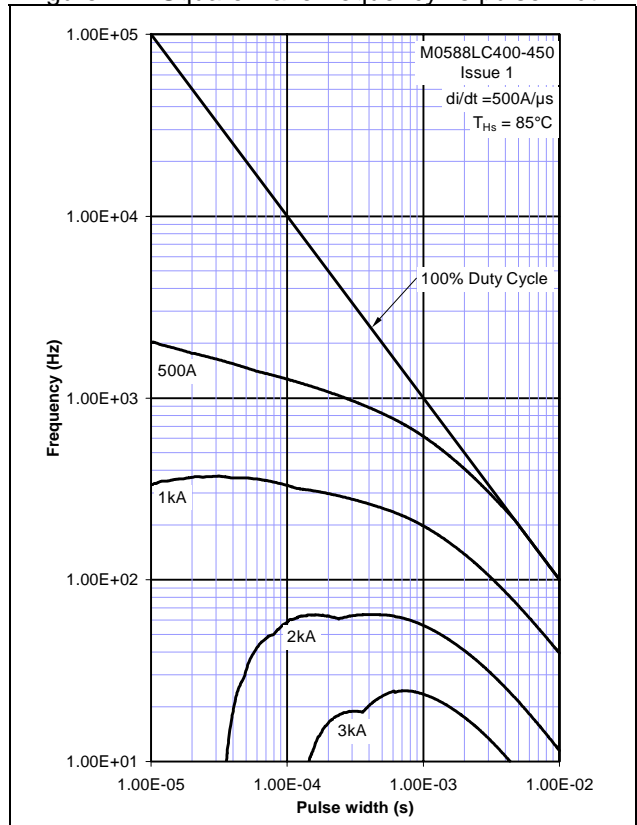

Figure 15 - Square wave energy per pulse

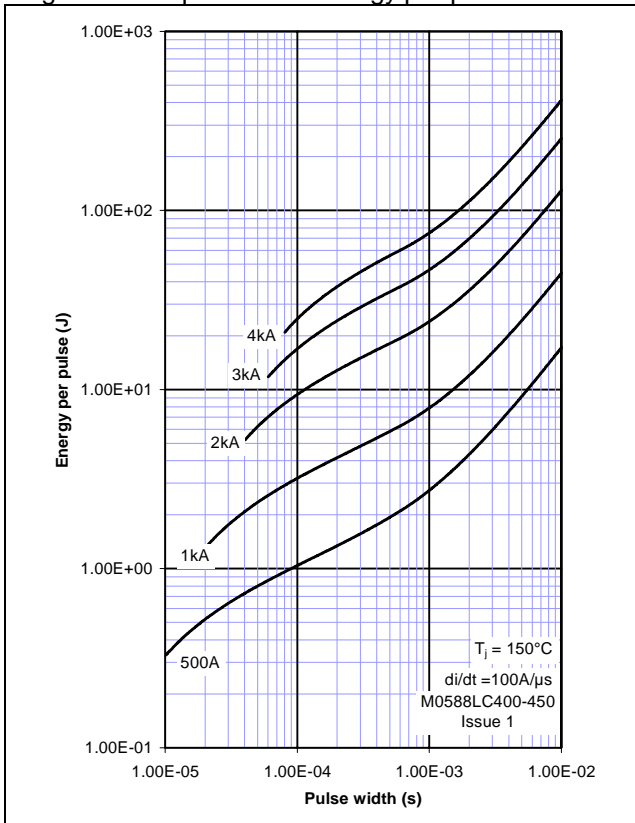

Figure 16 - Square wave energy per pulse

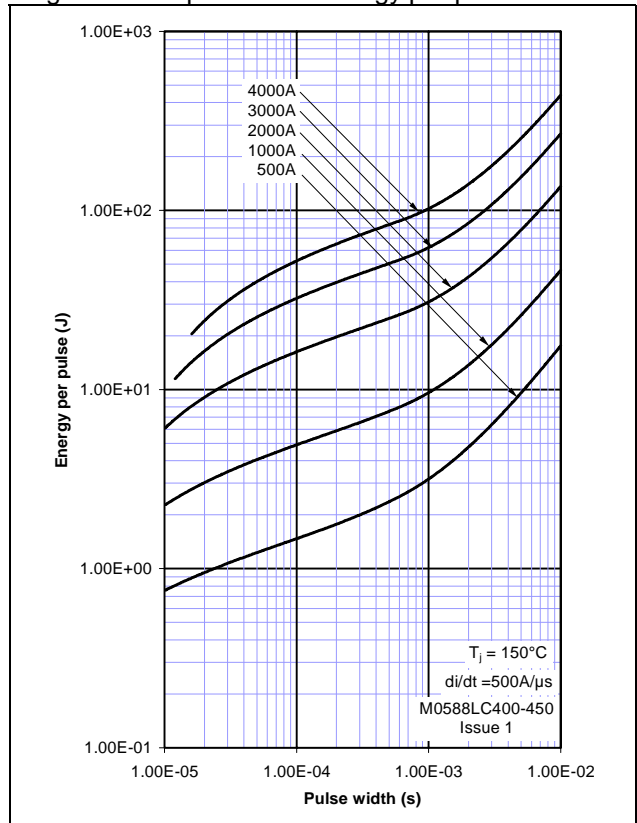

Figure 17 – Maximum surge and  $I^2t$  ratings

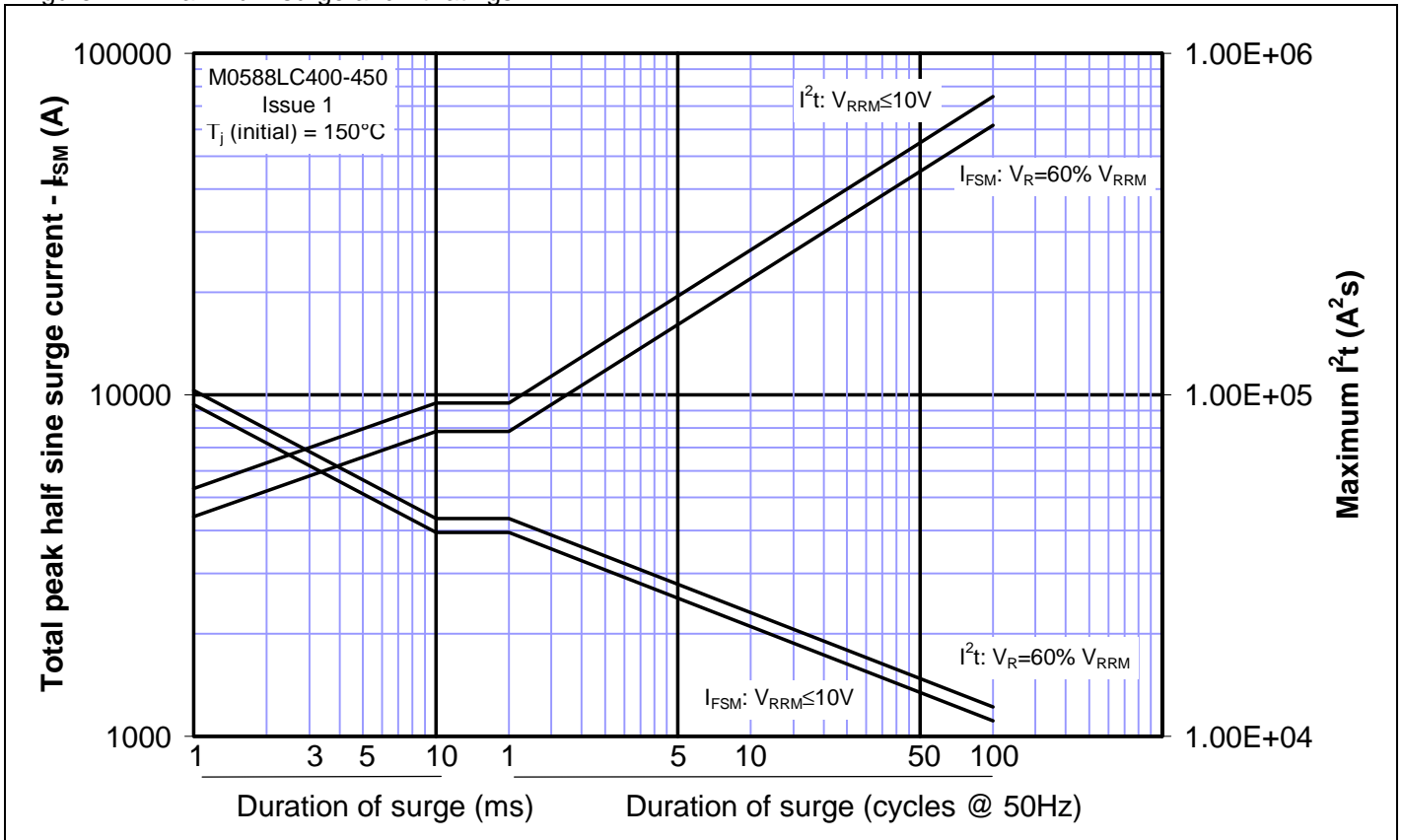
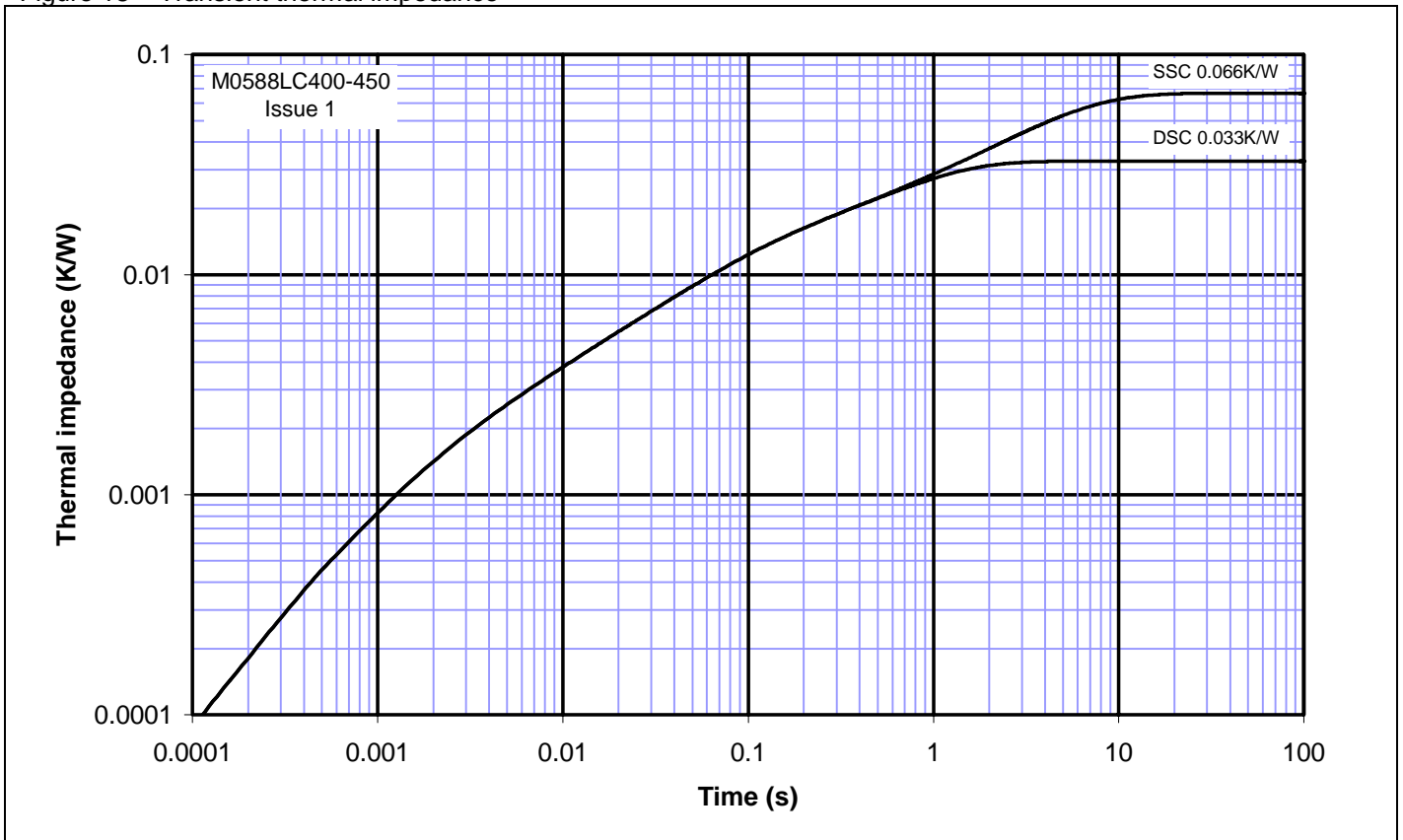
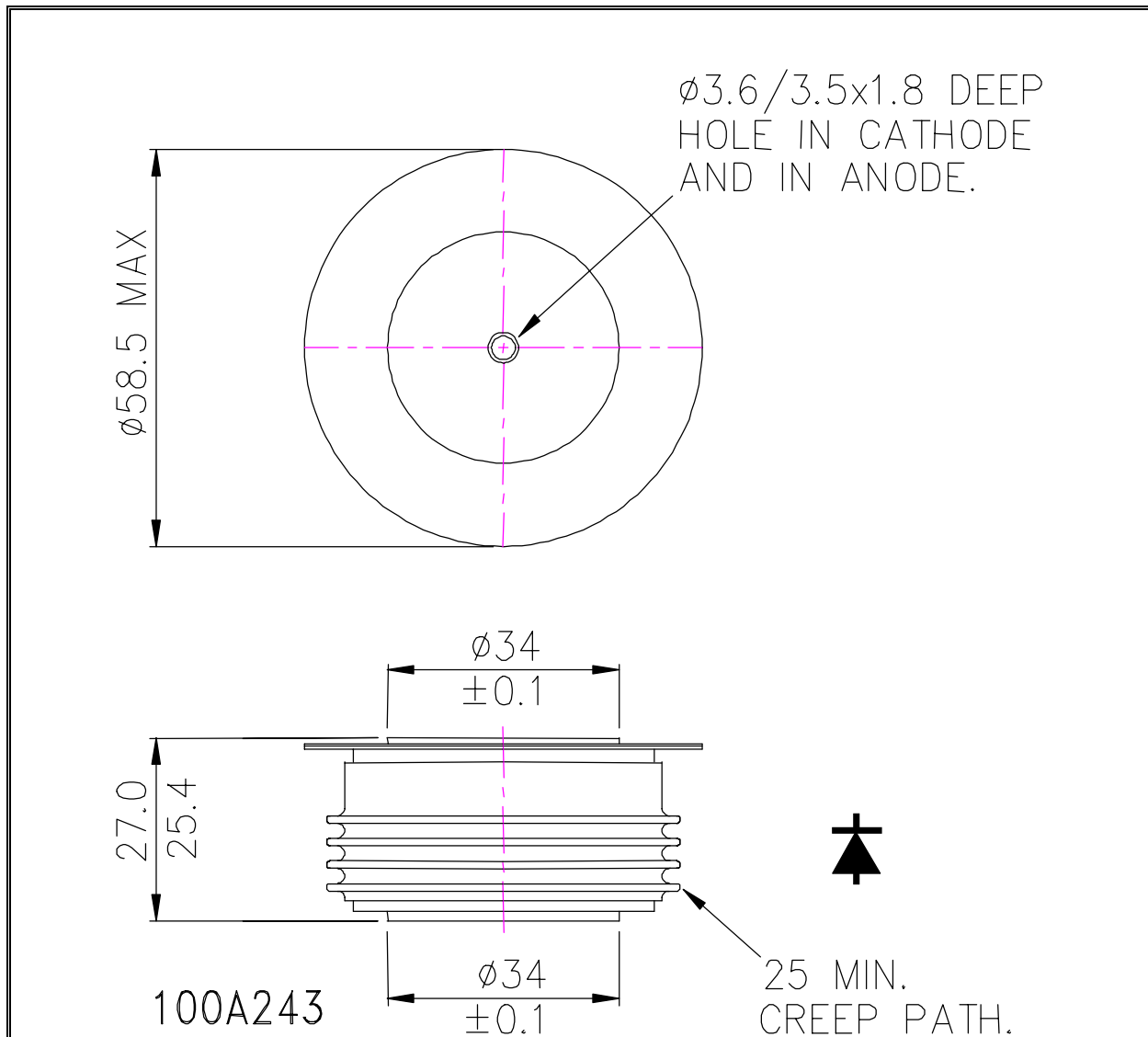

Figure 18 – Transient thermal impedance



**Outline Drawing & Ordering Information**



**ORDERING INFORMATION** (Please quote 10 digit code as below)

|                 |                 |                    |                    |            |
|-----------------|-----------------|--------------------|--------------------|------------|
| <b>M</b>        | <b>0588</b>     | <b>LC</b>          | <b>◆◆</b>          | <b>0</b>   |
| Fixed Type Code | Fixed Type code | Fixed outline code | Voltage code 40-45 | Fixed code |

Typical order code: M0588LC420 – 4200V  $V_{RRM}$ , 27mm clamp height capsule.

**WESTCODE**

UK: Westcode Semiconductors Ltd.  
 P.O. Box 57, Chippenham, Wiltshire, England. SN15 1JL.  
 Tel: +44 (0) 1249 444524 Fax: +44 (0) 1249 659448  
 E-Mail: [WSL.sales@westcode.com](mailto:WSL.sales@westcode.com)

USA: Westcode Semiconductors Inc.  
 3270 Cherry Avenue, Long Beach, California 90807  
 Tel: +1 (562) 595 6971 Fax: +1 (562) 595 8182  
 E-Mail: [WSI.sales@westcode.com](mailto:WSI.sales@westcode.com)

Internet: <http://www.westcode.com>

The information contained herein is confidential and is protected by Copyright. The information may not be used or disclosed except with the written permission of and in the manner permitted by the proprietors Westcode Semiconductors Ltd.

© Westcode Semiconductors Ltd.

In the interest of product improvement, Westcode reserves the right to change specifications at any time without prior notice.

Devices with a suffix code (2-letter or letter/digit/letter combination) added to their generic code are not necessarily subject to the conditions and limits contained in this report.



---

Disclaimer Notice - Information furnished is believed to be accurate and reliable. However, users should independently evaluate the suitability of and test each product selected for their own applications. Littelfuse products are not designed for, and may not be used in, all applications. Read complete Disclaimer Notice at [www.littelfuse.com/disclaimer-electronics](http://www.littelfuse.com/disclaimer-electronics).