

# MICRO2™ Blade Fuses

Rated 32V



## Description

MICRO2™ blade fuses employ subminiature design, which allows them to provide more automotive circuit protection in less space. MICRO2 fuses have also passed performance tests proving their reliability in polluted, humid, and high-temperature environments.

## Features & Benefits

- Color coding shows the amperage rating for each fuse
- See-through housing makes it easy to check whether a fuse has blown
- Checkpoints on top make it possible to measure resistance without removing the fuse
- Simple to install and remove
- Comply with ISO 8820-12:2020
- High-contrast amperage stamp on the top of the housing aids identification.
- Silver plating allows up to 150 °C at the terminal interface

## Applications

- Cars / SUVs
- Trucks
- Offroad vehicles
- Buses
- Watercraft as approved by Littelfuse®

[See Disclaimer Notice](#)

## Additional Information



Resources

## Specifications

<b>Voltage Rating:</b>	32 V DC
<b>Interrupting Rating:</b>	1000 A @ 32 V DC
<b>Recommended Environmental Temperature:</b>	-40 °C to +125 °C
<b>Terminals Material:</b>	Silver-plated or Tin-plated zinc alloy *
<b>Housing Material:</b>	PA66 (UL 94 Flammability rating of V-2)
<b>Typical Weight per Fuse:</b>	0.53 g
<b>Comply With:</b>	ISO 8820-10:2020, SAE 2741

\*Note: Silver plating allows up to 150 °C at the terminal interface.









## Ordering Information

Part Number	Plating	Current Rating (A)	Package Size
0327xxx.YX2S	Ag	3-30 & SHUNT	4000
0327xxx.UXS	Ag	3-30	500
0327xxx.LXS	Ag	3-30	50
0327xxx.YX2T	Sn	5-30	4000

# MICRO2™ Blade Fuses

## Rated 32V

### Ratings

Part Number	Current Rating (A)	Housing Material Color	Test Cable Size (mm <sup>2</sup> )	Typ. Voltage Drop (mV)	Typ. Cold Resistance (mΩ)	$I^2t$ (A <sup>2</sup> s)
0327003_	3 <sup>1</sup>		0.35	113	31.7	9
0327005_	5		0.5	116	17.4	17
032707.5_	7.5		0.75	106	10.8	47
0327010_	10		1	102	7.7	90
0327015_	15		1.5	94	4.9	190
0327020_	20		2.5	91	3.5	400
0327025_	25		2.5	90	2.6	580
0327030_	30		4	88	2.1	1000
0327900_	SHUNT		-	-	-	-

<sup>1</sup> Available only with Silver plating.

**Note:** The typical  $I^2t$  is an average value calculated from the breaking capacity tests by using the melting time before the arcing occurs.

### Dimensions

Dimensions in mm. Please refer to the outline drawing for dimensions and tolerances.

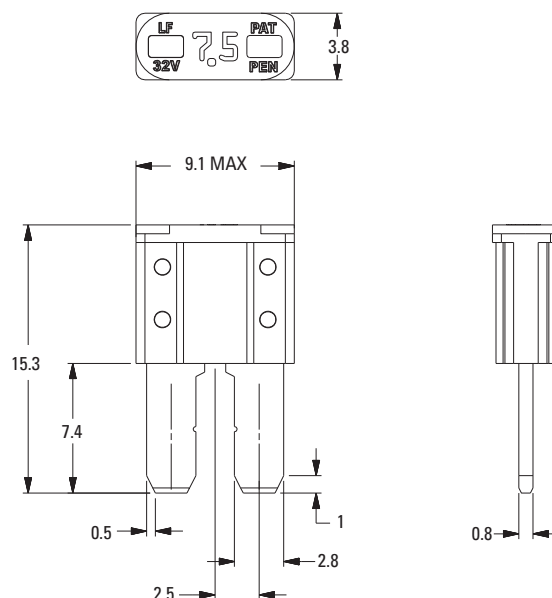

# MICRO2™ Blade Fuses

## Rated 32V

### Time-Current Characteristic

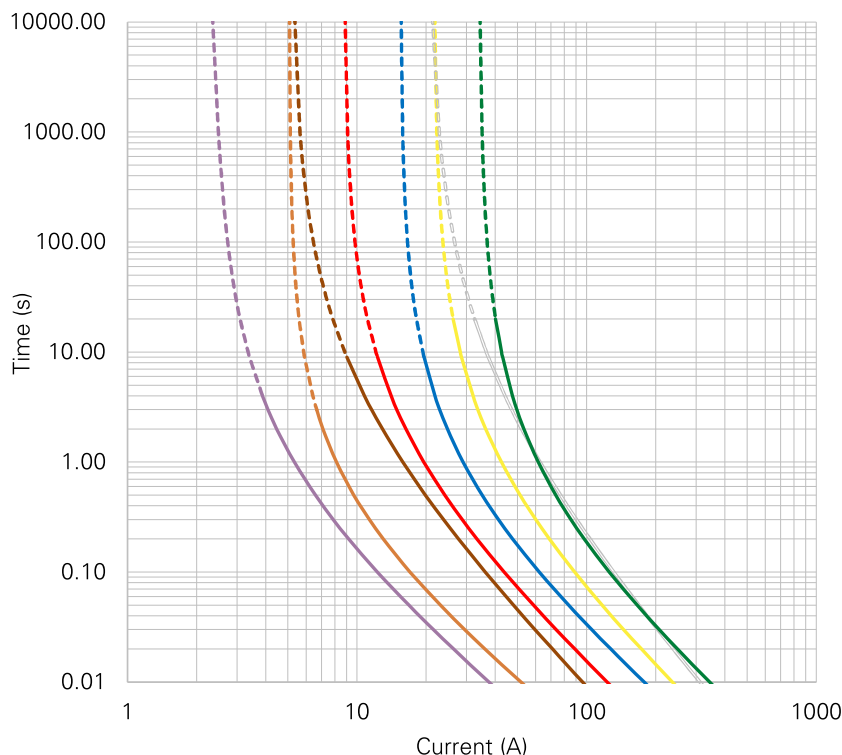

% of Rating	Opening Time Min. / Max. (s)
110	360 000 / -
135	0.75 / 120
160	0.3 / 50
200	0.15 / 5
350	0.04 / 0.5
600	0.02 / 0.1

- 3A      — 15A
- 5A      — 20A
- 7.5A    — 25A
- 10A     — 30A

**Note:** Current recommendation may be impacted by the final condition of the application (terminals characteristics, wire size etc.). Please contact Littelfuse® for more information.

### Typical Derating Curves

Temperature security margin is 20%.  
Please contact Littelfuse® for Details Regarding Derating Test Set Up

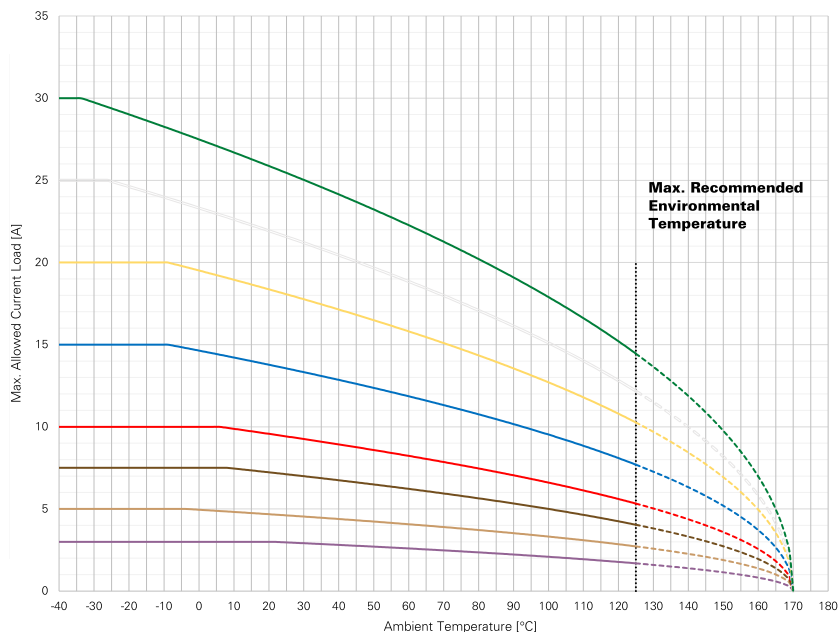

**Max. allowed current load (A) at ambient temperature based on typical derating**

	-40 °C	0 °C	20 °C	65 °C	85 °C	110 °C	125 °C
<b>3 A</b>	3	3	3	3	2	2	2
<b>5 A</b>	5	5	5	4	4	3	3
<b>7.5 A</b>	7.5	7.5	7	6	5	5	4
<b>10 A</b>	10	10	10	8	7	6	5
<b>15 A</b>	15	15	14	12	10	9	8
<b>20 A</b>	20	20	18	15	14	12	10
<b>25 A</b>	25	23	22	18	17	14	12
<b>30 A</b>	30	27	26	22	20	17	14

- 3A      — 15A
- 5A      — 20A
- 7.5A    — 25A
- 10A     — 30A

MICRO2 SHUNT  
Maximum Continuous Load: 20A.

**Note:** Current recommendation may be impacted by the final condition of the application (terminals characteristics, wire size etc.). Please contact Littelfuse® for more information.

**Disclaimer Notice** - Information furnished is believed to be accurate and reliable. However, users should independently evaluate the suitability of and test each product selected for their own applications. Littelfuse products are not designed for, and may not be used in, all applications. Read complete Disclaimer Notice at <https://www.littelfuse.com/legal/disclaimers/product-disclaimer.aspx>