

MIDI IH Series

Bolt-down Fuses – Rated 32 V-SF30

RoHS



Description

Innovative body design ensure an increased accessibility for sockets and ring terminals on new Littelfuse MIDI Improved Housing 32 V bolt-down fuses.

Additional improvements include making color-coded ampere markings more visible to OCR scanners and housing features which allow this new MIDI fuse 32 V to withstand up to 10.5 Nm of torque on mounting screws (contact a Littelfuse expert to receive details on the test setup).

Available with current ratings from 30 A to 200 A, these fuses are optimized for use in automotive applications and refer to ISO 8820-5 standard, type SF30.

Features & Benefits

- High-contrast ampere rating stamp on housing aids identification
- Available with two or one mounting holes
- Refer to ISO 8820-5
- High accessibility for screwing operation
- Maximum tightening torque up to 10.5 Nm *

Additional Information



Resources



Samples

Applications

- Cars / SUVs
- Trucks
- Offroad vehicles
- Buses
- Watercraft as approved by Littelfuse®

[See Disclaimer Notice](#)

Specifications

Voltage Rating:	32 V DC
Interrupting Rating:	2000 A @ 32 V DC
Recommended Environmental Temperature:	-40 °C to +125 °C
Terminals Material:	Tin-plated copper alloy
Housing Material:	PA66-GF25 (UL 94 Flammability rating of V-0)
Mounting Torque M6:	Recommended: 6 Nm ± 1 Nm (acc. ISO) Max. 10.5 Nm (with specific test setup)
Typical Weight per Fuse:	3.2 g
Comply With:	ISO 8820-5 – Type SF30

MIDI IH Series











Bolt-down Fuses – Rated 32 V-SF30

Ordering Information

Part Number	Plating	Current Rating (A)		Package Size
0498xxx.MX2M6-IH	30-200	M6	2	800
0498xxx.MX1M6-IH	30-200	M6	1	800

*Note: With specific test setup. Please contact Littelfuse for more details.

Ratings

Part Number	Current Rating (A)	Housing Material Color	Test Cable Size (mm ²)	Typ. Voltage Drop (mV)	Typ. Cold Resistance (mΩ)	Typ. I ² t (A ² s)
0498030_	30		2.5	65	2.06	4200
0498040_	40		4	65	1.40	10 000
0498050_	50		6	65	1.02	13 000
0498060_	60		6	68	0.87	21 700
0498070_	70		10	70	0.72	24 000
0498080_	80		10	58	0.54	24 600
0498100_	100		16	60	0.46	51 300
0498125_	125		25	71	0.39	73 200
0498150_1	150		25	49 ³	0.32	81 900
0498175_1,2	175		25	53 ³	0.29	100 000
0498200_1	200		35	51 ³	0.26	125 000

Note 1: The typical I²t is an average value calculated from the breaking capacity tests by using the melting time before the arcing occurs.

Note 2: Short Circuit Protector only

Note 3: Color Coding deviating from ISO standard

Note 4: Measured at 75% I_r

Dimensions

Dimensions in mm. Please refer to the outline drawing for dimensions and tolerances.

2-Holes M6 version

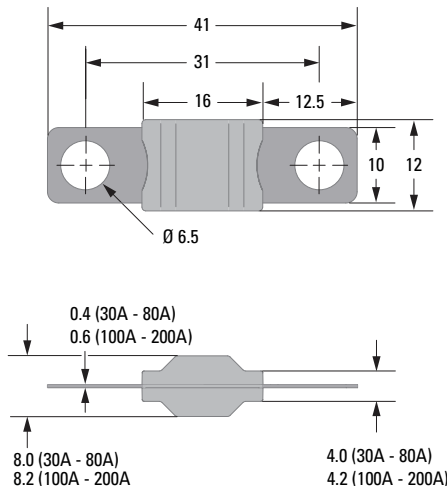

1-Hole M6 version

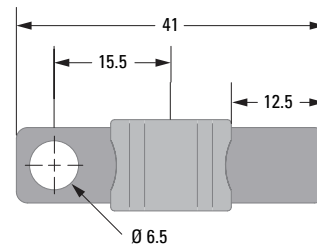

MIDI IH Series

Bolt-down Fuses – Rated 32 V-SF30

Time-Current Characteristic

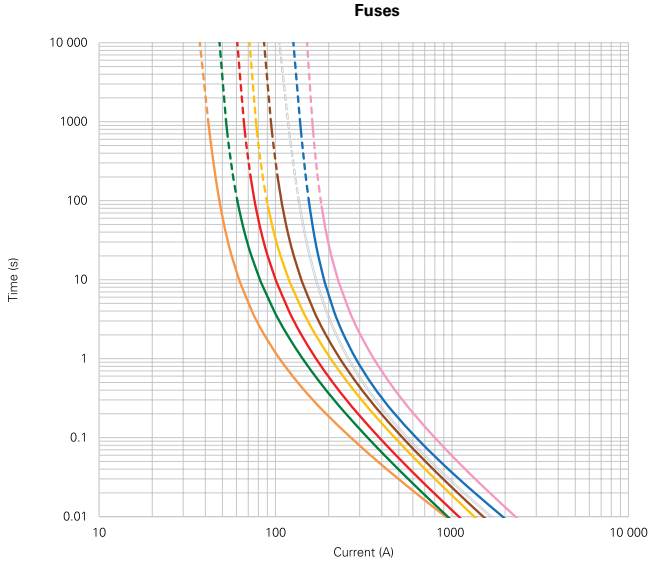

% of Rating	Opening Time Min. / Max. (s)
	30A-125A
75	- / -
100	360 000 / -
110	14 400 / -
150	90 / 3600
200	3 / 100
300	0.3 / 3
350	- / -
500	0.1 / 1
600	- / -

- 30 A
- 40 A
- 50 A
- 60 A
- 70 A
- 80 A
- 100 A
- 125 A

Note 1: Current recommendation may be impacted by the final condition of the application (terminals characteristics, wire size etc.). Please contact Littelfuse® for more information.

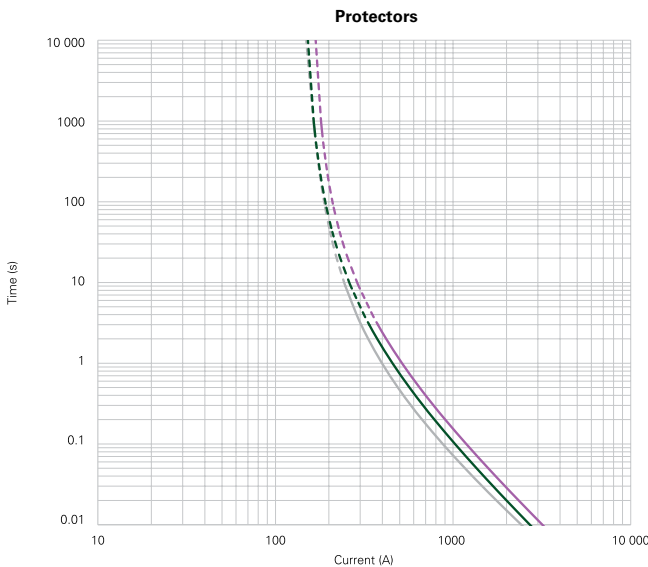

% of Rating	Opening Time Min. / Max. (s)
	150A-200A
75	360 000 / -
100	- / -
110	- / -
150	- / -
200	1 / 15
300	- / -
350	0.3 / 5
500	- / -
600	0.1 / 1

- 150 A
- 175 A
- 200 A

Note 1: Current recommendation may be impacted by the final condition of the application (terminals characteristics, wire size etc.). Please contact Littelfuse® for more information.

MIDI IH Series

Bolt-down Fuses – Rated 32 V-SF30

Typical Derating of Fuse Melting Element

Temperature Security Margin is 20%

Wire Cross Section And Fixture Test Set Up Refer To ISO 8820-5

Please Contact Littelfuse® For Details Regarding Derating Test Set Up

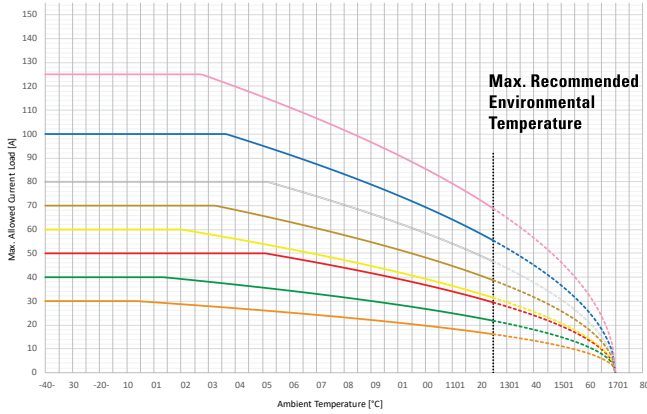

Max. allowed current load (A) at ambient temperature based on typical derating							
	-20 °C	0 °C	20 °C	65 °C	85 °C	110 °C	125 °C
30 A	30	30	28	24	22	18	16
40 A	40	40	38	32	29	25	22
50 A	50	50	50	45	41	34	29
60 A	60	60	58	48	43	36	31
70 A	70	70	70	59	53	45	39
80 A	80	80	80	72	65	64	55
100 A	100	100	100	85	77	64	55
125 A	125	125	124	104	94	79	69



Note 1: Current recommendation may be impacted by the final condition of the application (terminals characteristics, wire size etc.). Please contact Littelfuse® for more information.

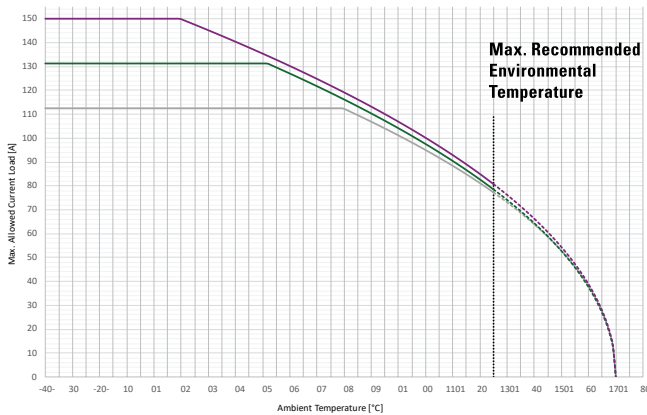

Max. allowed current load (A) at ambient temperature based on typical derating							
	-20 °C	0 °C	20 °C	65 °C	85 °C	110 °C	125 °C
150 A	113	113	113	113	104	88	77
175 A	131	131	131	119	107	90	79
200 A	150	150	145	122	110	93	81

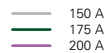

Note 1: Current recommendation may be impacted by the final condition of the application (terminals characteristics, wire size etc.). Please contact Littelfuse® for more information.

Disclaimer Notice - Information furnished is believed to be accurate and reliable. However, users should independently evaluate the suitability of and test each product selected for their own applications. Littelfuse products are not designed for, and may not be used in, all applications. Read complete Disclaimer Notice at <https://www.littelfuse.com/legal/disclaimers/product-disclaimer.aspx>