

Current Sensor

CH1S01xB

Preliminary Datasheet Target Specification Rev. 1.1



General Description

The Littelfuse CH1S010B current sensor family utilizes open loop Hall Effect technology to provide dual channel, ratio-metric output signals proportional to the magnetic flux density generated by internal C-core concentrators.

Typical Application Diagram

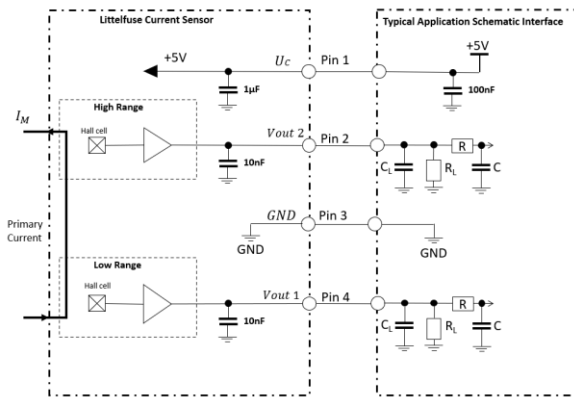

$C_L \geq 1.0nF, C_L \leq 10.0nF$ for EMC protection
 $R_L \geq 10k\Omega, R_L \leq 200k\Omega$ pull-down resistor on signal line

Output Characteristics

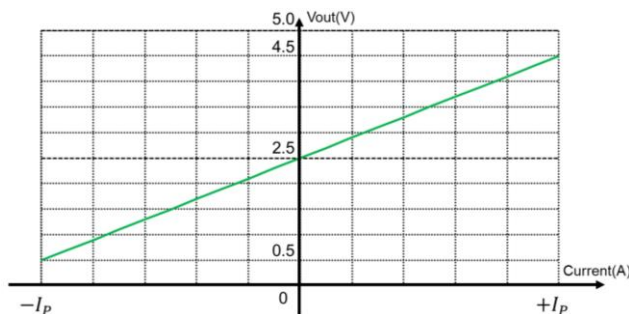

* I_P : Primary current range

Features

- Open Loop Hall effect current sensor
- Unipolar +5V DC power supply
- Analog ratio-metric output
- Operating temperature range:
-40 °C < T < +125 °C
- Single or dual channel measurement
 - Channel 1: up to ±100A
 - Channel 2: up to ±1100A

Benefits

- High sensing accuracy
- Low thermal offset drift
- Low thermal sensitivity drift
- Non-intrusive solution
- Dual channel measurement

Applications

- Battery Management System
- Hybrid Vehicles
- EV and Utility Vehicles

Mechanical Characteristics

- Plastic: PBT-GF25 (UL94-V0)
- Pins: CuSn6, Sn plating
- Mass: ~ 93g
- Protection degree: IP41

Mating Connector

- TE 1-1456426-5

Current Sensor

CH1S01xB



Preliminary Datasheet Target Specification Rev. 1.1

Littelfuse Current Sensor Naming Convention

Measure	Technology	Measurement Point Cnt.	Mount type	Family	Mechanical version	Application	-	Single / Dual Range	Range A	Range B High Range for Dual	Signal Type	-	ASIL
C	H	1	S	01	0	M		S	01	01	A		Q
V	HS	2	B	02	1	B		D	02	02	P		A
T	F	3	P	03	2	P		R	03	03	C		B
	HF			04	3	R			04	04	CT120		C
	FS			05	4	C			05	05	L		D
				06	5				06	...	S		
				...	6				...	11	CA		
				99	7				15	15	U		
					8				20	20			
					9								

C=Current V=Voltage T=Temperature	H=Hall HS=Shunt+Hall F=Fluxgate HF=Fluxgate+Hall FS=Shunt+Fluxgate S=Shunt	S=Stand Alone B=with Busbar P=PCB mount	M = Motor Control B = BMS P = Pyro Trigger R = Relay Trigger C = Charger	S=Single D=Dual R=Redundant	01 - 100 02 - 200 03 - 300 04 - 400 05 - 500 06 - 600 09 - 900 ... 20 - 2000	01 - 100 02 - 200 03 - 300 04 - 400 05 - 500 06 - 600 09 - 900 ... 20 - 2000	A=Analog P=PWM C=CAN no termination CT120=CAN 120 Ohm termination L=LIN S=SENT CA = CAN + Analog U=UART	Q=QM A=ASIL A B=ASIL B C=ASIL C D=ASIL D
--	--	--	--	---	---	---	---	---

Product Name by configuration

Part Name	Config	Ref. Image
CH1S010B	Standard	
CH1S011B	Aperture variant (one flat)	

Current Range Definition

Littelfuse offers customized calibration ranges.

Current ranges notation:

CH1S01xB-SxxyyA-Q

- D: Single, Dual or Redundant range output
- xx: Primary current range (Channel 1)
- yy: Primary current range (Channel 2)
-
- A: Analog output
- Q: ASIL QM

Naming Examples:

Type Name	Current Range Chanel 1	Current Range Chanel 2
CH1S01xB-D0105A-Q	±100 A	±500 A
CH1B01xB-D0108A-Q	±100 A	±800 A
CH1B01xB-D0110A-Q	±100 A	±1000 A
CH1B01xB-D0111A-Q	±100 A	±1100 A

Current Sensor

CH1S01xB

Preliminary Datasheet Target Specification Rev. 1.1

Absolute Maximum Ratings (non-operating)

Parameter	Symbol	Min	Typ.	Max	Units	Comments
Maximum Supply Voltage	U_{CMAX}	-0.3		10	V	
Peak Primary Current RMS	\hat{I}_{P_RMS}				A	limited by busbar temp. ¹
Maximum Output Current	I_{CMAX}	-10		10	mA	
Storage Temperature	T_{ST}	-40		+125	°C	
Insulation Resistance	R_{INS}	500			MΩ	500V DC, 60s
Dielectric voltage	I_{LEAK}			1	mA	2.5 kV AC, 50Hz, 1min
Creepage distance	D_{CREE}		3.5		mm	
Clearance	D_{CLEA}		3.1		mm	
Comparative tracking index	CTI		PLC0 (≥600 V)		V	UL746A (IEC 60112)

Mechanical Product Properties

Parameter	Symbol	Level	Standard	Comments
Flammability Class		V0	UL94	
Protection Degree		IP 41	IEC 60529	

¹ Maximum RMS primary current is limited by the busbar surface temperature.

Current Sensor

CH1S01xB

Preliminary Datasheet Target Specification Rev. 1.1

Common Characteristics in Normal Range

Parameter	Symbol	Min	Typ.	Max	Units	Comments
Supply Voltage	U_C	4.75	5	5.25	V	
Current Consumption	I_C	16	25	30	mA	$U_C = 5V, I_p = 0A$;
Operating Ambient Temperature	T_A	-40		+125 ²	°C	
Output Voltage	V_{out}	0.5		4.5	V	See page
Output Offset Voltage	V_o		2.5		V	$U_C = 5V, I_p = 0A$
Clamping Voltage Lower	V_{CL}		0.3		V	
Clamping Voltage Upper	V_{CU}		4.7		V	
Supply Capacitance	C_{SUP}	47	100		nF	Capacitors to be located near supply pins
Load Capacitance	C_L		2.2	10	nF	
Load Resistance	R_L	10	25	200	kΩ	
Power-on Time	t_{po}		1		ms	
Response Time	t_r		20		μs	$C_L = 2.2$ nF

² Busbar surface temperature shall not exceed 150 °C - Primary current frequencies can cause heating of the busbar and magnetic core.

Current Sensor

CH1S01xB

Preliminary Datasheet Target Specification Rev. 1.1

Primary Current Range for Channel 1 (Low Range): up to $\pm 100\text{A}$

Littelfuse offers customized low range calibrations.
Below performance data are applicable for $\pm 100\text{A}$ calibration.

Parameter	Symbol	Min	Typ.	Max	Units	Comments
Primary Current	I_p	-100		+100	A	
Sensitivity for $\pm 100\text{A}$	S		20		mV/A	UC = 5V
Linearity Error	ϵ_L		± 0.5		%FS	UC = 5V, over temp.
Offset Error	ϵ_o	± 0.5		± 0.5	%FS	UC = 5V, over temp.
Sensitivity Error	ϵ_s		± 1.2		%FS	UC = 5V, over temp.

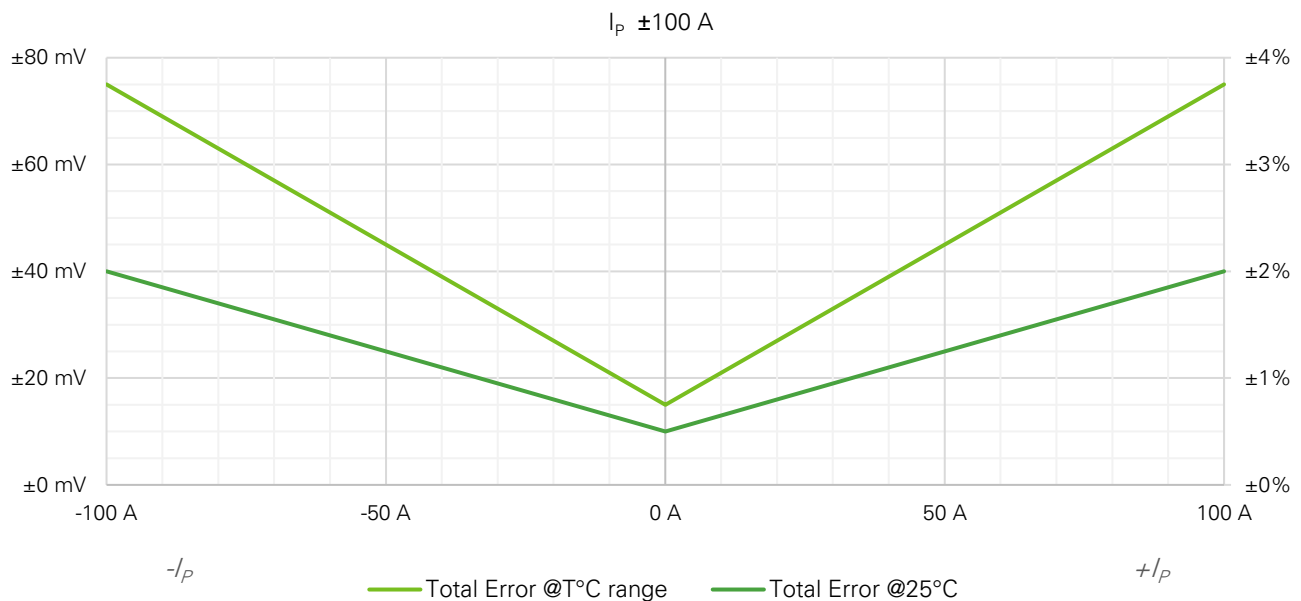

Primary Current	Total Error @25°C			Total Error @T°C range			
	A	mV	%	A	mV	%	A
$-I_p$ (-100 A)		$\pm 40\text{ mV}$	$\pm 2\%$	$\pm 2.00\text{ A}$	$\pm 75\text{ mV}$	$\pm 3.75\%$	$\pm 3.75\text{ A}$
0		$\pm 10\text{ mV}$	$\pm 0.5\%$	$\pm 0.50\text{ A}$	$\pm 15\text{ mV}$	$\pm 0.75\%$	$\pm 0.75\text{ A}$
$+I_p$ (+100 A)		$\pm 40\text{ mV}$	$\pm 2\%$	$\pm 2.00\text{ A}$	$\pm 75\text{ mV}$	$\pm 3.75\%$	$\pm 3.75\text{ A}$

Current Sensor

CH1S01xB

Preliminary Datasheet Target Specification Rev. 1.1

Primary Current Range for Channel 2 (High Range): up to ± 900 A

Littelfuse offers customized high range calibration ranges up to 1100 A.
Below performance data are applicable for ± 100 A ... ± 900 A calibration.

Parameter	Symbol	Min	Typ.	Max	Units	Comments
Primary Current	I_p	-900		+900	A	
Sensitivity for ± 900 A	S		2.22		mV/A	$U_c = 5V$
Linearity Error	ϵ_L		± 0.5		%FS	$U_c = 5V$, over temp.
Offset Error	ϵ_o	± 0.9		± 0.9	%FS	$U_c = 5V$, over temp.
Sensitivity Error	ϵ_s		± 1.2		%FS	$U_c = 5V$, over temp.

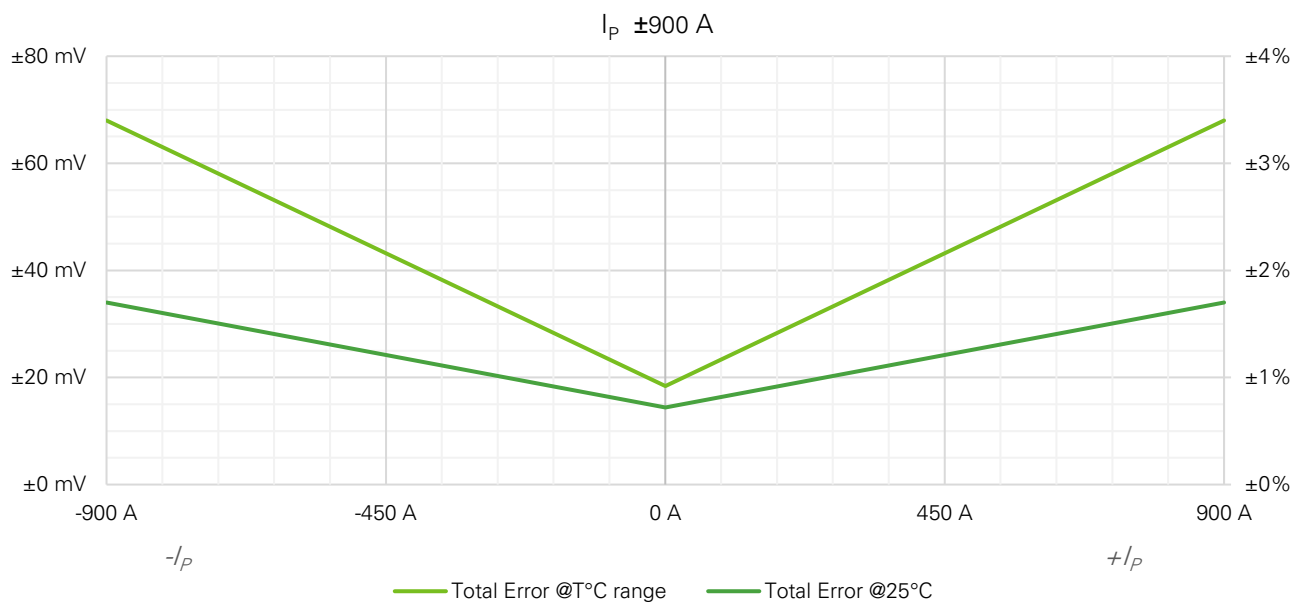

Primary Current	Total Error @25°C			Total Error @T°C range		
	A	mV	%	A	mV	%
$-I_p$ (-900 A)		± 28.6 mV	$\pm 1.7\%$	± 15.3 A	± 68 mV	$\pm 3.4\%$
0		± 14.4 mV	$\pm 0.7\%$	± 6.48 A	± 18.4 mV	$\pm 0.9\%$
$+I_p$ (+900 A)		± 28.6 mV	$\pm 1.7\%$	± 15.3 A	± 68 mV	$\pm 3.4\%$

Current Sensor

CH1S01xB

Preliminary Datasheet Target Specification Rev. 1.1

Primary Current Range for Channel 2 (High Range): up to 1100 A (extended range)

Littelfuse offers customized high range calibration ranges up to 1100 A.
Below performance data are applicable for ± 900 A ... ± 1100 A calibration.

Parameter	Symbol	Min	Typ.	Max	Units	Comments
Primary Current	I_p	-1100		+1100	A	
Sensitivity for ± 1100 A	S		1.82		mV/A	$U_c = 5V$
Linearity Error in ± 900 A	ϵ_L		± 0.5		%FS	$U_c = 5V$, over temp.
Offset Error	ϵ_o	± 1.2		± 1.2	%FS	$U_c = 5V$, over temp.
Sensitivity Error	ϵ_s		± 1.2		%FS	$U_c = 5V$, over temp.

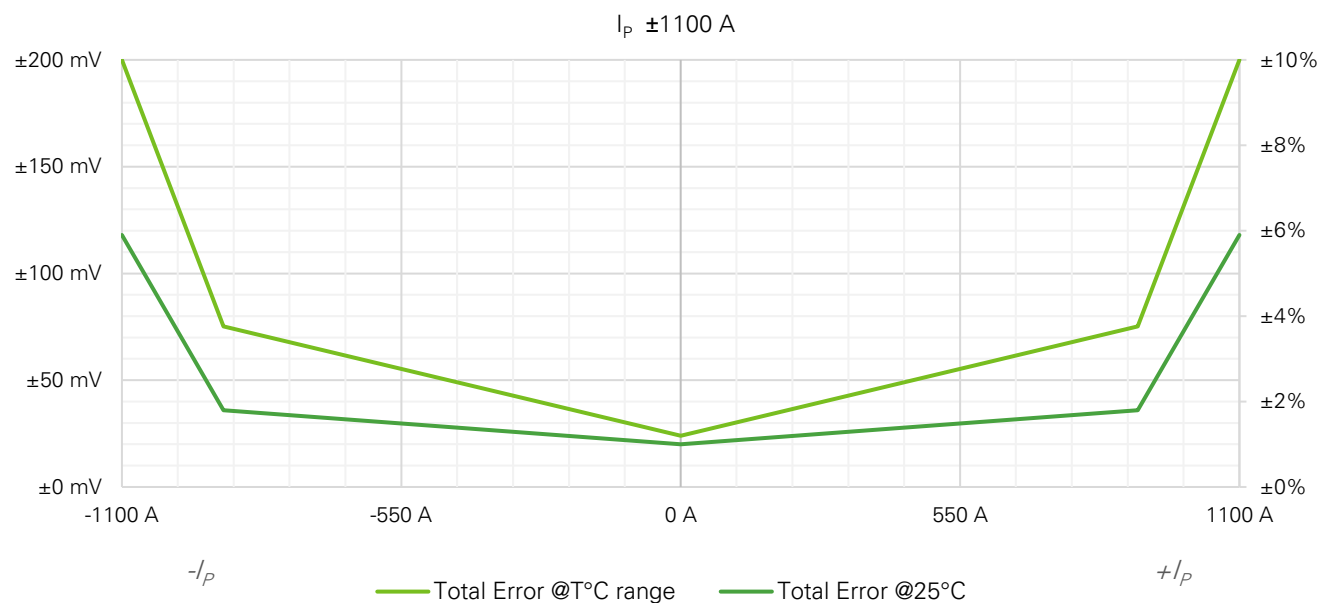

Primary Current	Total Error @25°C			Total Error @Trange			
	A	mV	%	A	mV	%	A
$-I_p$ (-1100 A)		± 118.2 mV	$\pm 5.9\%$	± 65.0 A	± 200 mV	$\pm 10\%$	± 110 A
-900		± 36.4 mV	$\pm 1.8\%$	± 20.0 A	± 75.3 mV	$\pm 4.6\%$	± 41.4 A
0		± 20.0 mV	$\pm 1.0\%$	± 11.0 A	± 24.0 mV	$\pm 1.2\%$	± 13.2 A
+900		± 36.4 mV	$\pm 1.8\%$	± 20.0 A	± 75.3 mV	$\pm 3.4\%$	± 41.4 A
$+I_p$ (+1100 A)		± 118.2 mV	$\pm 5.9\%$	± 65.0 A	± 200 mV	$\pm 10\%$	± 110 A

Current Sensor

CH1S01xB

Preliminary Datasheet Target Specification Rev. 1.1

Recommendations for Use

Setup Recommendation

Mounting:



- M4 screw mounted with flat/spring washer or serrated flanged screw is recommended.
- Assembly torque: 1.5 N·m \pm 10%
- Preferred busbar orientation is parallel with connector.

Adjacent Busbar Spacing:

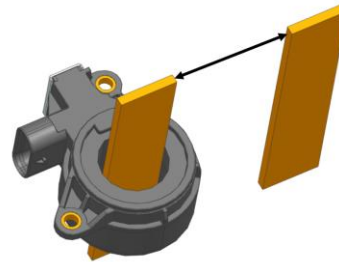

- The distance between sensor cable/busbar and adjacent cable/busbar is recommended to be more than 50mm @1100A
- Adjacent busbar should not pass directly above or below current sensor housing.
- Busbar layout should be reviewed with Littelfuse for compatibility.

Handling

- Handling of sensors should be minimized by maintaining parts within packaging until point of assembly.
- Contact with sensor terminals should be avoided.
- To avoid potential damage, adherence to ESD handling best practices is recommended.
- Dropped parts should be scrapped regardless of evidence of external damage.

Current Sensor

CH1S01xB

Preliminary Datasheet Target Specification Rev. 1.1

Validation Test Specification

Group / Test	Reference	Test Condition
Environmental		
Low temperature storage test	ISO 16750-4	
Low temperature operation test	ISO 16750-4	
High temperature operating endurance test (HTOE)	ISO 16750-4	
Powered thermal cycle endurance	IEC 60068-2-14 Nb	
Thermal shock	EN 60068-2-14 ISO16750-4 §5.3.2	
High temperature and humidity endurance	JESD22-A101	
Salt mist	IEC 60068-2-11	
Mechanical		
Temperature Vibration Test	ISO 16750-3 § 4.1.2.4	
Mechanical Shock	ISO 16750-3 §4.2.2.2	
Free-Fall	ISO 16750-3 § 4.3	
Dust proof	IEC 60529	
Waterproof	IEC 60529	
Electrical		
Single line interruption	ISO 16750-2 §4.9.1	
Reverse supply voltage	-0.3 V for 60 s	
Overvoltage	10 V for 60 s	
Power-on time test	Littelfuse VS	Vdd min to 90% Vout
Response time test	Littelfuse VS	90% Primary current to 90% Vout
Output short circuit to supply	ISO16750-2 §4.10	
Electrical heat rise		100A DC per step for heat rise step
DC insulation resistance	ISO 16750-2 §4.1.2.2	
AC insulation test (Dielectric voltage)	IEC 60664	
EMC		
BCI test	ISO 11452-4 Annex E.1.1, Table E.1	
Radiated electromagnetic immunity	ISO 11452-2	
Radiated emissions	CISPR 25	
ESD handling Test	ISO 10605 §7	
Connector		
Terminal push-out force test	GMW3191:2012 §4.5.2	
Connector to connector engagement force test	GMW3191:2012 §4.2.8/ USCAR25	
Locked connector disengagement force test	GMW3191:2012 §4.2.18	
Unlocked connector disengagement force test	GMW3191:2012 §4.2.19	

Current Sensor

CH1S01xB

Preliminary Datasheet Target Specification Rev. 1.1

Performance Parameter Definitions

Output voltage definition (V_{out})

$$V_{out} = (U_C/5) \times (V_O + I_p \times S)$$

Primary current definition (I_N, I_p)

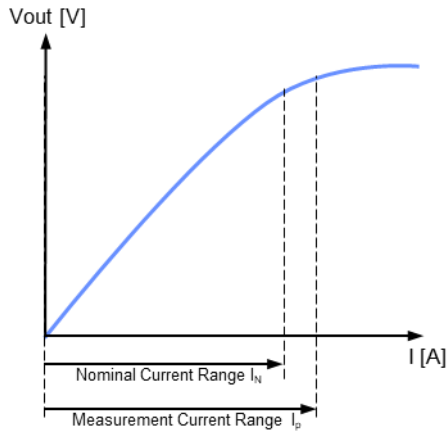

Linearity error (ϵ_L)

The maximum positive or negative discrepancy with a reference straight line $V_{out} = f(I_p)$.

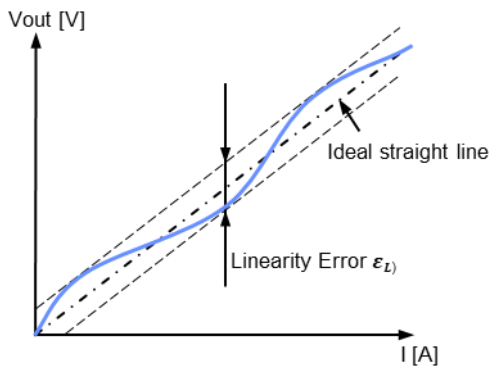

$$\epsilon_L = \pm \frac{\Delta V_{max}}{V_{FS}} \times 100\%$$

Offset error (ϵ_O)

The voltage drift of the measured sensor output V_{out} at 0A compared to the ideal value 2.5V (@ $V_C = 5V$) is called the total offset voltage error. This offset error can be attributed to the electrical offset, magnetic offset and related drift over temperature.

$$\epsilon_O = \pm \frac{V_{out} - V_O}{V_{FS}} \times 100\%$$

Sensitivity error (ϵ_S)

The sensor sensitivity error is the drift of sensor's ideal sensitivity.

$$\epsilon_S = \pm \frac{G - G_{th}}{G_{th}} \times 100\%$$

Power-on time (t_{po})

The Power-on time is the duration from $V_{DD}(\min.)$ to 90% of V_{out} .

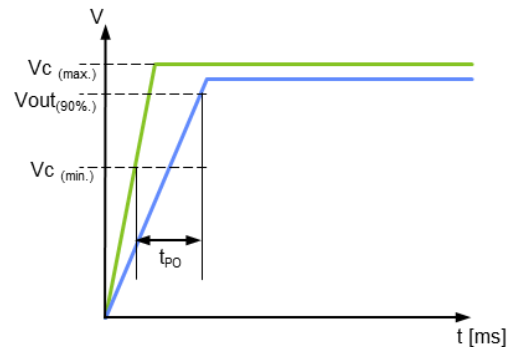

Response time (t_r)

The time between the primary current signal and the output signal reaching at 90% of its final value.

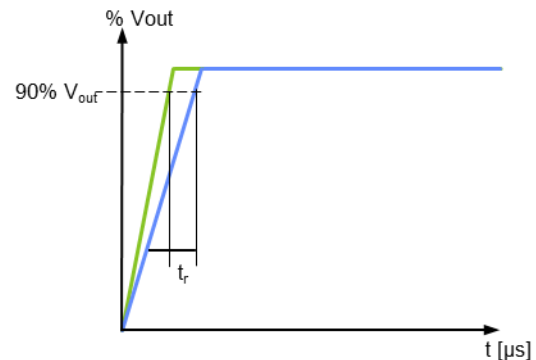

Typical minimum and maximum values

Typical minimum, and maximum values are determined during initial product characterization. Typical values representing the normal of statistical $\pm 1\sigma$ interval (68.27% probability).

Minimum and maximum values representing the Gaussian distribution boundaries of the $\pm 3\sigma$ interval (99.73% probability).

Current Sensor

CH1S01xB

Preliminary Datasheet Target Specification Rev. 1.1

Contact

Custom electrical and environmental specifications can be designed to meet any need, please contact Littelfuse Engineering for details.

Website: www.littelfuse.com
 Sales Support: ALL_Autosensors_Sales@littelfuse.com
 Technical Support: ALL_Autosensors_Tech@littelfuse.com

Revision	Date	Name	Change
1.0	28-Apr-2023	Florent Jolly	Released Preliminary datasheet based on A-Sample results – technical review by Rimantas Radzys
1.1	12-Mar-2024	Stephen Hanks	Added definition for CH1S011B Revised assembly torque (1.5 N·m was 2.5 N·m) Revised chart format

Disclaimer Notice - Information furnished is believed to be accurate and reliable. However, users should independently evaluate the suitability of and test each product selected for their own applications. Littelfuse products are not designed for, and may not be used in, all applications. Read complete Disclaimer Notice at <https://www.littelfuse.com/legal/disclaimers/product-disclaimer>.

Information provided by Littelfuse is believed to be accurate and reliable.

All rights reserved. Trademarks and registered trademarks are the property of their respective owners.

Littelfuse products are designed for specific applications and should not be used for any purpose (including, without limitation, automotive applications) not expressly set forth in applicable Littelfuse product documentation. Warranties granted by Littelfuse shall be deemed void for products used for any purpose not expressly set forth in applicable Littelfuse product documentation. Littelfuse shall not be liable for any claims or damages arising out of products used in applications not expressly intended by Littelfuse as set forth in applicable Littelfuse product documentation.

Document version: Preliminary Datasheet 1.1
 Date of print: 12MAR24