

preliminary

X2PT IGBT

$V_{CES} = 4500 \text{ V}$

$I_{C25} = 74 \text{ A}$

$V_{CE(sat)} = 2.8 \text{ V}$

Very High Voltage
Single IGBT

Part number
IXG 50I4500KN

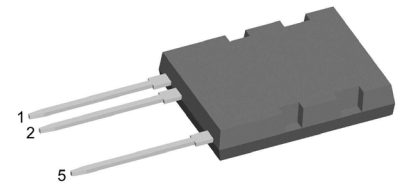

Backside: isolated
see important note page 3

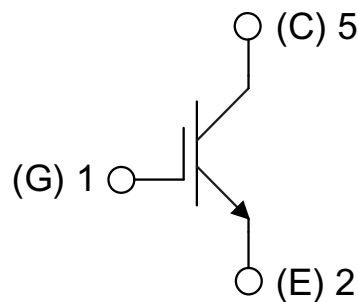

Features / Advantages:

- Easy paralleling due to the positive temperature coefficient of the on-state voltage
- Short circuit rated for 10 μ sec.
- Very low gate charge
- Low EMI

Applications:

- AC motor drives
- Solar inverter
- Medical equipment
- Uninterruptible power supply
- Air-conditioning systems
- Welding equipment
- Switched-mode and resonant-mode power supplies
- Inductive heating, cookers
- Pumps, Fans
- Pulse application
- Capacitor discharge

Package: ISOPLUS264

- Isolation voltage 4200 V~
see important note on page 3
- Industry standard outline
- RoHS compliant
- Epoxy meets UL 94V-0
- Soldering pins for PCB mounting
- Backside: DCB ceramic
- Reduced weight
- Advanced power cycling

Disclaimer Notice

Information furnished is believed to be accurate and reliable. However, users should independently evaluate the suitability of and test each product selected for their own applications. Littelfuse products are not designed for, and may not be used in, all applications. Read complete Disclaimer Notice at www.littelfuse.com/disclaimer-electronics.

IGBT				Ratings		
Symbol	Definitions	Conditions	min.	typ.	max.	
V_{CES}	collector emitter voltage				4500	V
V_{GES}	max. DC gate voltage				± 20	V
V_{GEM}	max. transient gate emitter voltage				± 30	V
I_{C25}	collector current				74	A
I_{C80}					52	A
I_{C100}					42	A
P_{tot}	total power dissipation				368	W
$V_{CE(sat)}$	collector emitter saturation voltage	$I_C = 55 \text{ A}; V_{GE} = 15 \text{ V}$		2.8 3.65	3.2	V V
$V_{GE(th)}$	gate emitter threshold voltage	$I_C = 10 \text{ mA}; V_{GE} = V_{CE}$	5.5	6.3	7	V
I_{CES}	collector emitter leakage current	$V_{CE} = V_{CES}; V_{GE} = 0 \text{ V}$		0.5	0.1	mA mA
I_{GES}	gate emitter leakage current	$V_{GE} = \pm 20 \text{ V}$			500	nA
Q_{Gon}	total gate charge	$V_{CE} = 2800 \text{ V}; V_{GE} = 15 \text{ V}; I_C = 55 \text{ A}$		500		nC
$t_{d(on)}$	turn-on delay time	inductive load $V_{CE} = 2800 \text{ V}; I_C = 55 \text{ A}$ $V_{GE} = \pm 15 \text{ V}; R_G = 47 \Omega, C_{GE} = 6.8 \text{ nF}$ $T_{VJ} = 25^\circ\text{C}$		440		ns
t_r	current rise time			90		ns
$t_{d(off)}$	turn-off delay time			900		ns
t_f	current fall time			1310		ns
E_{on}	turn-on energy per pulse			123*		mJ
E_{off}	turn-off energy per pulse			69		mJ
$t_{d(on)}$	turn-on delay time	inductive load $V_{CE} = 2800 \text{ V}; I_C = 55 \text{ A}$ $V_{GE} = \pm 15 \text{ V}; R_G = 47 \Omega; C_{GE} = 6.8 \text{ nF}$ $T_{VJ} = 125^\circ\text{C}$		300		ns
t_r	current rise time			130		ns
$t_{d(off)}$	turn-off delay time			940		ns
t_f	current fall time			1350		ns
E_{on}	turn-on energy per pulse			150*		mJ
E_{off}	turn-off energy per pulse			73		mJ
RBSOA	reverse bias safe operating area	$V_{GE} = \pm 15 \text{ V};$ $V_{CEmax} = 4500 \text{ V}$			110	A
I_{CM}						
SCSOA	short circuit safe operation area	$V_{CEmax} = 4500 \text{ V}$ $V_{CE} = 3400 \text{ V}; V_{GE} = \pm 15 \text{ V}$ $R_G = 47 \Omega; \text{none repetitive}$			10	μs
t_{SC}	short circuit duration					
I_{SC}	short circuit current			200		A
R_{thJC}	thermal resistance junction to case				0.34	K/W
R_{thJH}	thermal resistance junction to heatsink				0.45	K/W

Note *: Measured with DHG50I4500KN as freewheeling diode

Package ISOPLUS264		Ratings				
Symbol	Definitions	Conditions	min.	typ.	max.	Unit
I_{RMS}	RMS current	per terminal			70	A
C_p	coupling capacity	between shorted pins and back side metallization				pF
$R_{pin-chip}$	resistance terminal to chip	$V_{CE} = V_{CE(sat)} + 2 \cdot I_C \cdot R_{pin-chip}$				mΩ
T_{VJM}	max. virtual junction temperature		-40		150	°C
T_{OP}	operation temperature		-40		125	°C
T_{stg}	storage temperature		-40		150	°C
Weight				10		g
F_C	mounting force with clip		40		130	N
$d_{Spp/App}$	creepage distance on surface / striking distance through air	terminal to terminal (pin 2 to pin 3)	10.2			mm
$d_{Spb/Apb}$		terminal to backside	6.4			mm
V_{ISOL}	isolation voltage	$t = 1$ second	50/60 Hz, RMS, $I_{ISOL} \leq 1$ mA		4200	V

Important note:

External clearances between pins and between pins and tab may be insufficient to prevent flash over under all conditions. It is the customer's responsibility to apply additional insulation appropriate to the application.

ISOPLUS264 is designed to isolate a max continuous operation voltage (DC) of 1700 V. The peak test voltage of 4200 V assures safety for transient voltages only. The package is not tested for partial discharge.

If the product is used outside the package design voltage range the customer must use additional electrical insulation. Extra insulation layers should be used both between the tab and any heatsink and between any conducting clip and the top surface of the package particularly when metal parts (such as a heatsink or a clip) are in contact.

Please note that the intention of this package is to provide customers with an encapsulated die for high voltage application but the responsibility rests entirely with the customer to ensure for safe operation.

Bodily injury cannot be excluded if this warning is disregarded. Device implementation is the end user's responsibility.

For a low FIT rate over lifetime failures due to SEB (Single Event Burnout) and an adequate voltage derating should be considered.

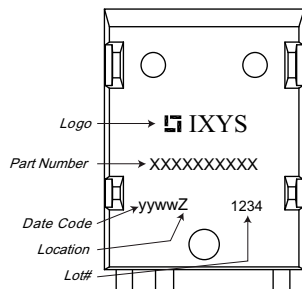
Product Marking

Part number

I = IGBT
 X = XPT IGBT
 G = Gern 2 / std
 50 = Current Rating [A]
 I = Single IGBT
 4500 = Reverse Voltage [V]
 KN = ISOPLUS264 (3HV)

Ordering	Part Name	Marking on Product	Delivering Mode	Base Qty	Ordering Code
Standard	IXG50I4500KN	IXG50I4500KN	Tube	25	IXG50I4500KN

Equivalent Circuits for Simulation

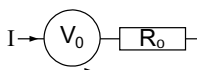
* on die level

 $T_{VJ} = 150$ °C

IGBT Diode

$V_{0\ max}$	threshold voltage	1.7	V
$R_{0\ max}$	slope resistance *	45	mΩ

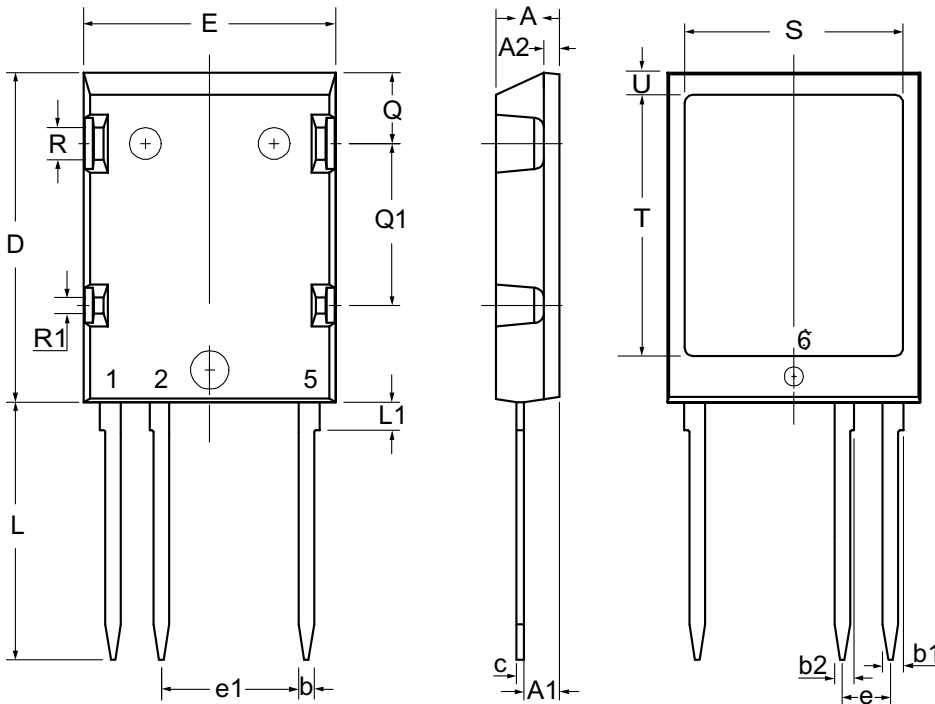
Outlines ISOPLUS264

Dim.	Millimeter		Inches	
	min	max	min	max
A	4.83	5.21	0.190	0.205
A1	2.59	3.00	0.102	0.118
A2	1.17	1.40	0.046	0.055
b	1.14	1.40	0.045	0.055
b1	1.60	1.83	0.063	0.072
b2	1.47	1.73	0.058	0.068
c	0.51	0.74	0.020	0.029
D	25.91	26.42	1.020	1.040
E	19.56	20.29	0.770	0.799
e	3.81 BSC		0.150 BSC	
e1	11.43 BSC		0.450 BSC	
L	19.81	20.83	0.780	0.820
L1	2.03	2.59	0.080	0.102
Q	5.33	5.97	0.210	0.235
Q1	12.45	13.03	0.490	0.513
R	3.81	4.57	0.150	0.180
R1	2.54	3.30	0.100	0.130
S	16.97	17.53	0.668	0.690
T	20.34	20.85	0.801	0.821
U	1.65	2.03	0.065	0.080

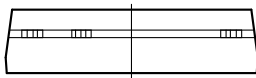

Pin 1 = Gate
 Pin 2 = Emitter
 Pin 5 = Collector
 Tab 6 = isolated

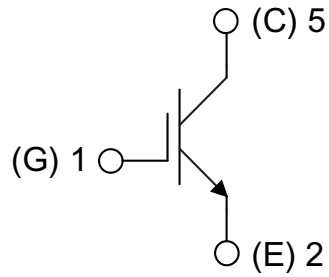

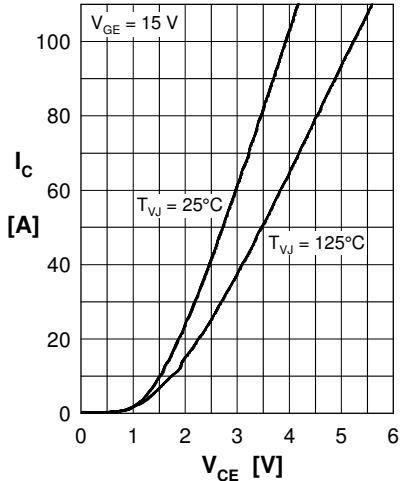

Fig. 1 Typ. output characteristics

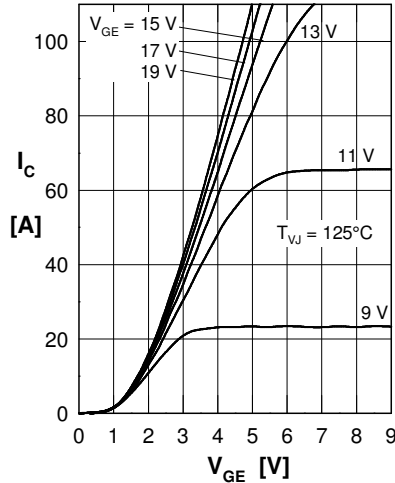

Fig. 2 Typ. transfer characteristics

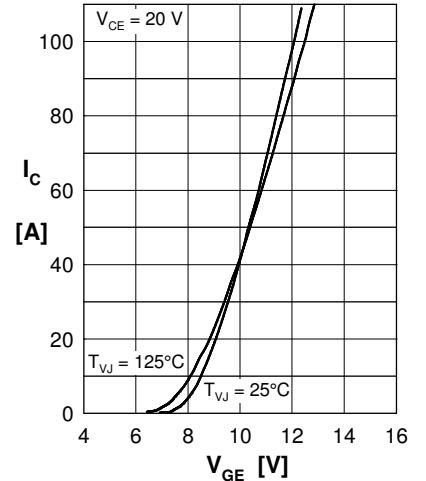

Fig. 3 Typ. transfer characteristics

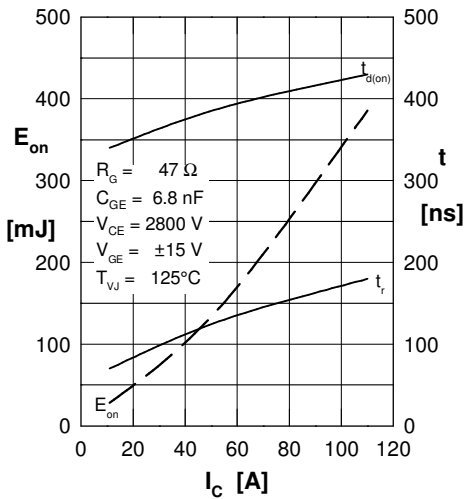

Fig. 4 Typ. turn-on energy and switching times vs. collector current, inductive switching

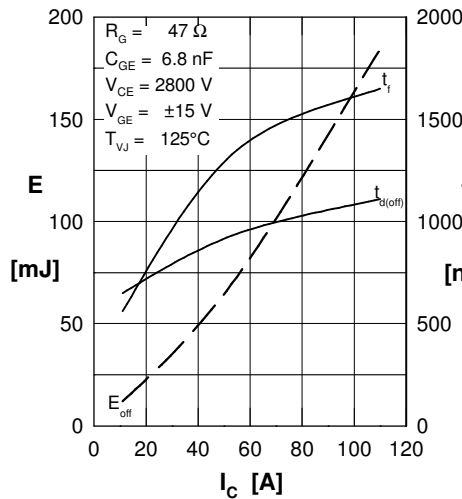

Fig. 5 Typ. turn-off energy and switching times vs. collector current, inductive switching

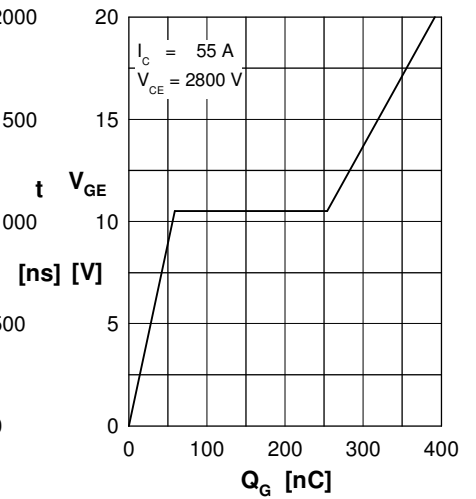

Fig. 6 Typ. turn-on gate charge

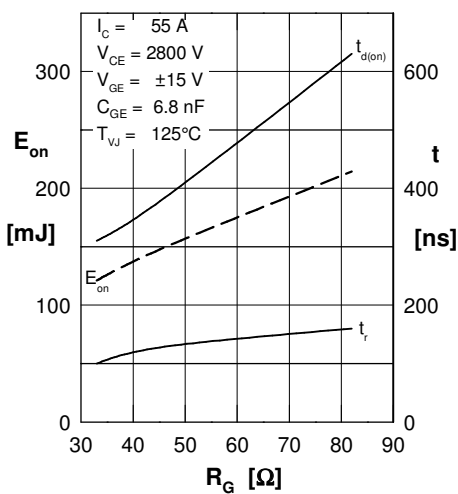

Fig. 7 Typ. turn-on energy and switching times vs. gate resistor, inductive switching

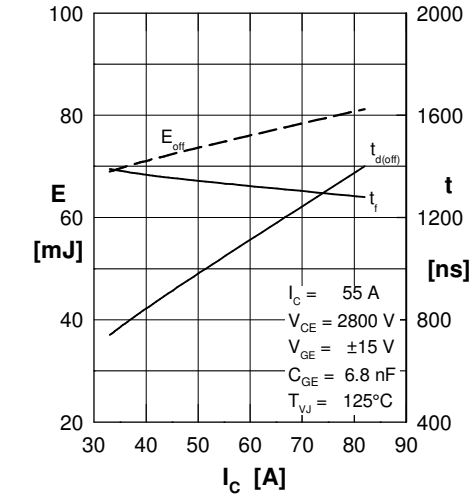

Fig. 8 Typ. turn-off energy and switching times vs. gate resistor, inductive switching

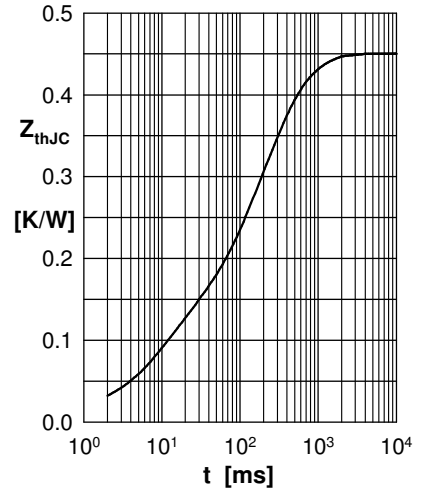

Fig. 8 Transient thermal impedance junction to case