

# KSPU SERIES

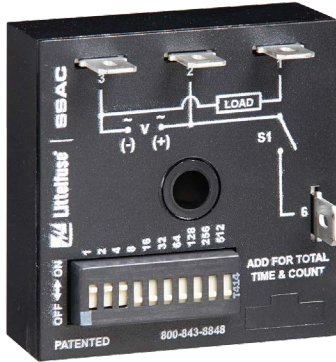

## Wiring Diagram

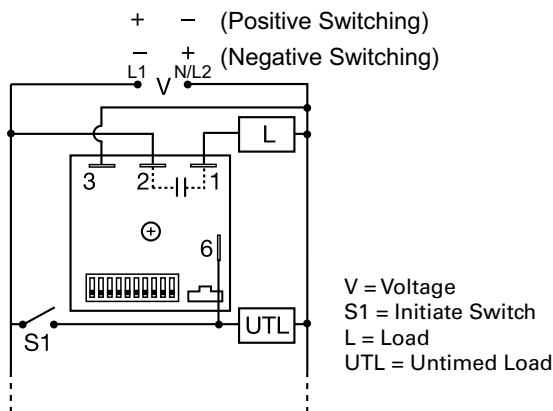



## Description

The KSPU Series is a factory programmed module available in any 1 of 14 standard functions. The KSPU offers a single adjustable timer or counter function. Switch adjustment allows accurate selection of the time delay or number of counts the first time and every time. The 1A steady, 10A inrush rated solid-state output provides 100 million operations, typical. Its microcontroller timing circuit provides excellent repeat accuracy and stability. Encapsulation protects against shock, vibration, and humidity. The KSPU Series is a cost effective approach for OEM applications that require small size, solid state reliability, and accurate switch adjustment.

## Features & Benefits

FEATURES	BENEFITS
<b>Microcontroller based</b>	Repeat Accuracy + / - 0.1%
<b>Compact design</b>	Allows flexibility for OEM applications
<b>1A steady, 10A inrush solid-state output</b>	Provides 100 million operations in typical conditions.
<b>Totally solid state and encapsulated</b>	No moving parts to arc and wear out over time and encapsulated to protect against shock, vibration, and humidity

## Accessories

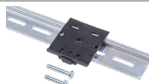
- 
**P1015-64 (AWG 14/16), P1015-14 (AWG 18/22) Female Quick Connect**  
 These 0.25 in. (6.35 mm) female terminals are constructed with an insulator barrel to provide strain relief.
- 
**P1015-18 Quick Connect to Screw Adapter**  
 Screw adapter terminal designed for use with all modules with 0.25 in. (6.35 mm) male quick connect terminals.
- 
**C103PM (AL) DIN Rail**  
 35 mm aluminum DIN rail available in a 36 in. (91.4 cm) length.
- 
**P1023-20 DIN Rail Adapter**  
 Allows module to be mounted on a 35 mm DIN type rail with two #10 screws.

## Ordering Information

MODEL	INPUT VOLTAGE	TIME DELAY/COUNTS	FUNCTION
KSPUA2I	24 to 240VAC	1 - 1023s	Interval
KSPUA8C	24 to 240VAC	1 - 1023 counts (binary) with pulsed output	Counter with pulsed output

If you don't find the part you need, call us for a custom product 800-843-8848

## KSPU SERIES

### Specifications

#### Time Delay

**Range\*** 0.1 - 102.3s, m or h in 0.1s, m or h increments  
 1 - 1023s, m or h in 1s, m or h increments  
 1 - 63s or m in 1s or m increments

**Repeat Accuracy** ±0.1% or 20 ms, whichever is greater

**Setting Accuracy** ≤ ±1% or 20 ms, whichever is greater

**Reset Time** ≤ 150ms

**Initiate Time** ≤ 20ms

#### Time Delay vs. Temperature & Voltage

≤ ±2%

#### Input

**Voltage/Tolerance** 24 to 240VAC, 12 to 120VDC/±15%

**AC Line Frequency/DC Ripple** 50/60 Hz/≤ 10%

**Power Consumption** AC ≤ 2VA; DC ≤ 1W

#### Output

**Type** Solid state

**Form** NO, SPST-NO

**Rating** 1A steady state, 10A inrush for 16ms

**Voltage Drop** AC ≅ 2.5V @ 1A; DC ≅ 1V @ 1A

**Off State Leakage Current** AC ≅ 5mA @ 240VAC; DC ≅ 1 mA

**Counter Output** Output pulse width: 300ms ±20%

Time Delay/Counts Variable 7 & 8

#### Protection

**Circuitry** Encapsulated

**Dielectric Breakdown** ≥ 2000V RMS terminals to mounting surface

**Insulation Resistance** ≥ 100 MΩ

**Polarity** DC units are reverse polarity protected

#### Mechanical

**Mounting** Surface mount with one #10 (M5 x 0.8) screw

**Dimensions** **H** 50.8 mm (2"); **W** 50.8 mm (2");

**D** 30.7 mm (1.21")

0.25 in. (6.35 mm) male quick connect terminals

#### Termination

**Environmental**

**Operating/Storage**

**Temperature**

-40° to 60°C / -40° to 85°C

**Humidity**

95% relative, non-condensing

**Weight**

≅ 2.4 oz (68 g)

\*For CE approved applications, power must be removed from the unit when a switch position is changed.

### Adjustment Switch Operation

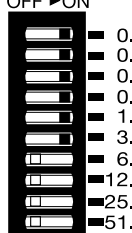
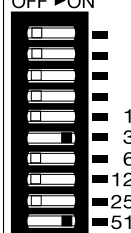
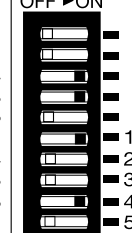
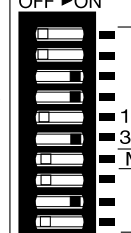
TIME DELAY		COUNTER	
0.1...102.3	1...1023	1...165	1...63
OFF ▶ ON	OFF ▶ ON	OFF ▶ ON	OFF ▶ ON
 0.1 0.2 0.4 0.8 1.6 3.2 6.4 12.8 25.6 51.2	 1 2 4 8 16 32 64 128 256 512	 1 2 3 4 5 10 20 30 40 50	 T 2 4 8 16 32 M* 1 2 4
6.3	544	57 counts	44 s Delay 2 counts to Start

\* for selecting time in minutes or seconds

### Function Diagrams

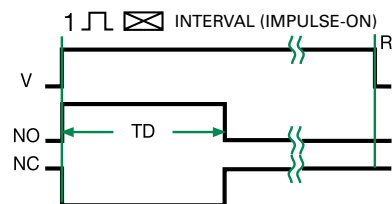
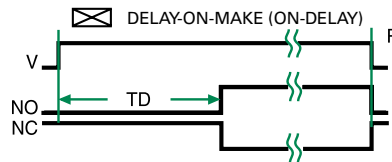

V = Voltage  
 NO = Normally Open Contact  
 NC = Normally Closed Contact  
 TD = Time Delay  
 R = Reset  
 = Undefined Time