

Parameter	Rating	Units
Relay Load Voltage	350	V
Relay Load Current	120	$\text{mA}_{\text{rms}} / \text{mA}_{\text{DC}}$
Relay On-Resistance (max)	15	Ω
Bridge Rectifier Reverse Voltage	100	V
Darlington Collector Current	120	mA
Darlington Current Gain	10,000	-

Features

- 3750V_{rms} Input/Output Isolation
- 2mW Hook Switch Drive Power (Logic Compatible)
- FCC Compatible Part 68
- Full-Wave Bridge Rectifier
- Darlington Transistor for Electronic Inductor “Dry” Circuits
- Full Wave Current Detector for Ring Signal or Loop Current Detect
- JEDEC Standard Pin-Out
- Board Space and Cost Savings
- Small 16-Pin SOIC Package

Applications

- Data/Fax Modem
- Voice Mail Systems
- Telephone Sets
- Computer Telephony Integration
- Set Top Box Modems

Description

This Integrated Telecom Circuit combines a single-pole, normally open (1-Form-A) solid state relay, a bridge rectifier, a Darlington transistor, and an optocoupler into one 16-pin SOIC package, consolidating designs and reducing component count in telecom applications.

The ITC117’s optocoupler provides for full-wave detection of ringing signals.

Approvals

- UL Recognized Component: File E76270
- CSA Certified Component: Certificate 1305490
- TUV EN 62368-1: Certificate B 082667 0008

Ordering Information

Part #	Description
ITC117P	16-Pin SOIC (50/Tube)
ITC117PTR	16-Pin SOIC (1000/Reel)

Pin Configuration

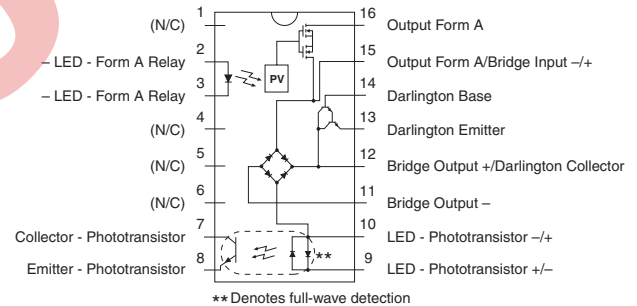

Switching Characteristics of Normally Open Devices

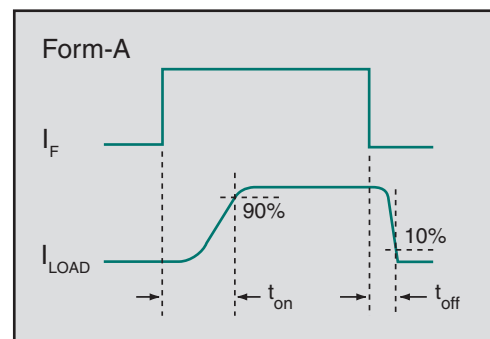

Absolute Maximum Ratings @ 25°C

Parameter	Ratings	Units
Input Control Current, Relay	50	mA
Input Control Current, Detector	100	mA
Total Package Dissipation ¹	1	W
Isolation Voltage, Input to Output	3750	V _{rms}
Operational Temperature	-40 to +85	°C
Storage Temperature	-40 to +125	°C

¹ Derate linearly 8.33 mW / °C

Total Power Dissipation (PD):

$$P_D = P_{\text{HOOKSWITCH}} + P_{\text{BRIDGE}} + P_{\text{DARLINGTON}} + P_{\text{LED}}$$

$$P_D = (P_{\text{DS(on)}})(I_F^2) + 2(V_F)(I_L) + (V_{\text{CE}})(I_L) + (V_{\text{LED}})(I_F)$$

WHERE:

- R_{DS(on)} = Maximum relay on resistance
- I_L = Maximum loop current
- V_F = Maximum diode forward voltage
- V_{CE} = Maximum voltage collector to emitter
- V_{LED} = Maximum LED forward voltage
- I_F = Maximum LED current

Absolute Maximum Ratings are stress ratings. Stresses in excess of these ratings can cause permanent damage to the device. Functional operation of the device at conditions beyond those indicated in the operational sections of this data sheet is not implied.

Typical values are characteristic of the device at +25°C, and are the result of engineering evaluations. They are provided for information purposes only, and are not part of the manufacturing testing requirements.

Electrical Characteristics @25°C: Relay Section

Parameter	Conditions	Symbol	Min	Typ	Max	Units
Output Characteristics						
Blocking Voltage (Peak)	-	V _L	-	-	350	V _P
Load Current						
Continuous	-	I _L	-	-	120	mA _{rms} / mA _{DC}
Peak	t=10ms	I _{LPK}	-	-	400	mA _P
On-Resistance	I _L =120mA	R _{ON}	-	-	15	Ω
Off-State Leakage Current	V _L =350V, T _J =25°C	I _{LEAK}	-	-	1	μA
Switching Speeds						
Turn-On	I _F =5mA, V _L =10V	t _{on}	-	-	3	ms
Turn-Off	I _F =5mA, V _L =10V	t _{off}	-	-	3	ms
Output Capacitance	V _L =50V, f=1MHz	C _{OUT}	-	25	-	pF
Input Characteristics						
Input Control Current to Activate	I _L =120mA	I _F	-	-	5	mA
Input Voltage Drop	I _F =5mA	V _F	0.9	1.2	1.4	V
Reverse Input Voltage	-	V _R	-	-	5	V
Reverse Input Current	V _R =5V	I _R	-	-	10	μA

Electrical Characteristics @25°C: Detector Section

Parameter	Conditions	Symbol	Min	Typ	Max	Units
Output Characteristics						
Phototransistor Blocking Voltage	$I_C=10\mu A$	BV_{CEO}	20	50	-	V
Phototransistor Dark Current	$V_{CE}=5V, I_F=0mA$	I_{CEO}	-	50	500	nA
Saturation Voltage	$I_C=2mA, I_F=16mA$	V_{SAT}	-	0.3	0.5	V
Current Transfer Ratio	$I_F=6mA, V_{CE}=0.5V$	CTR	33	400	-	%
Input Characteristics						
Input Control Current	$I_C=2mA, V_{CE}=0.5V$	I_F	-	2	6	mA
Input Voltage Drop	$I_F=5mA$	V_F	0.9	1.2	1.4	V
Input Current (Detector Must be Off)	$I_C=1\mu A, V_{CE}=5V$	I_F	5	25	-	μA

Electrical Characteristics @25°C (Unless Otherwise Noted): Bridge Rectifier Section

Parameter	Conditions	Symbol	Min	Typ	Max	Units
Reverse Voltage	-	V_{RD}	-	-	100	V
Forward Voltage Drop	$I_{FD}=120mA$	V_{FD}	-	-	1.5	V
Reverse Leakage Current	$T_J=25^\circ C, V_R=100V$	I_{RD}	-	-	10	μA
	$T_J=85^\circ C$		-	-	50	
Forward Current	-	I_{FD}	-	-	140	mA
Continuous	-		-	-	500	
Peak	$t=10ms$		-	-	500	

Electrical Characteristics @25°C: Darlington Transistor Section

Parameter	Conditions	Symbol	Min	Typ	Max	Units
Collector-Emitter Voltage	$I_C=10mA_{DC}, I_B=0mA$	V_{CEO}	40	-	-	V
Collector Current, Continuous	$V_C=3.5V$	I_C	-	-	120	mA
Power Dissipation	-	P_D	-	-	500	mW
Off-State Collector-Emitter Leakage Current	$V_{CE}=10V, I_B=0mA$	I_{CEX}	-	-	1	μA
DC Current Gain	$V_{CE}=10V_{DC}, I_C=120mA$	h_{FE}	10,000	-	-	-
Saturation Voltage	$I_C=120mA$	$V_{CE(sat)}$	-	-	1.5	V
Total Harmonic Distortion	$I_C=40mA, f_O=300Hz @ -10dBm$	-	-	-	-80	dB

DEVICE PERFORMANCE DATA*

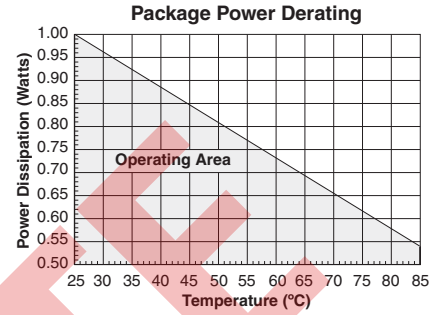
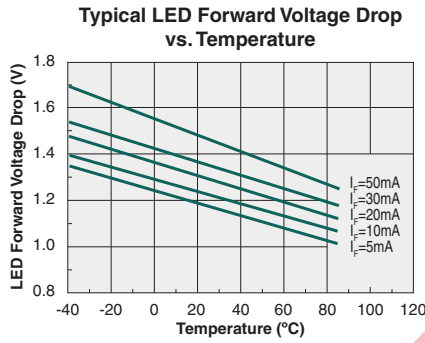
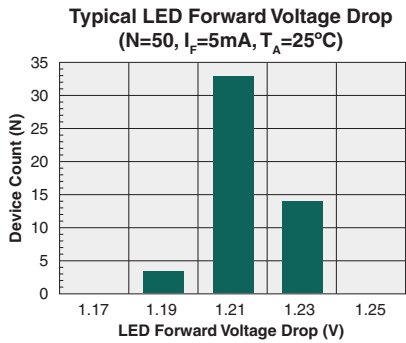

RELAY PERFORMANCE DATA*

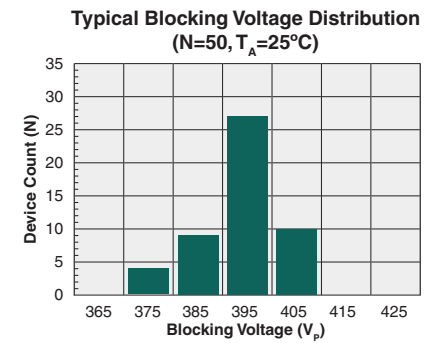
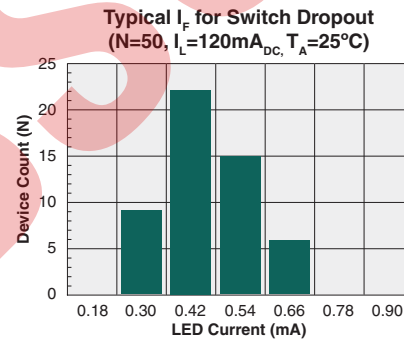
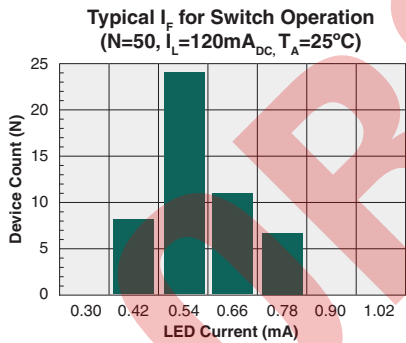
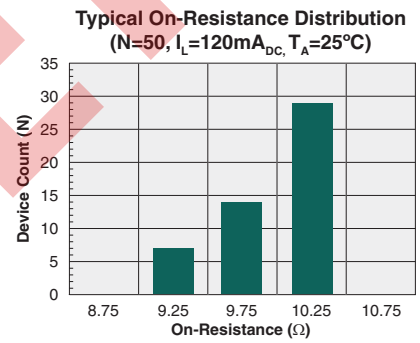
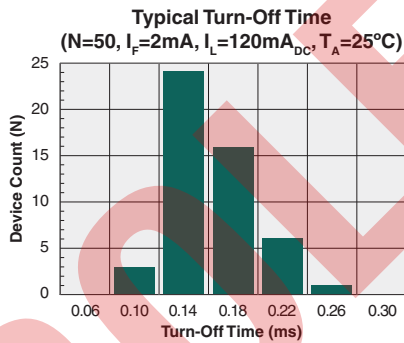
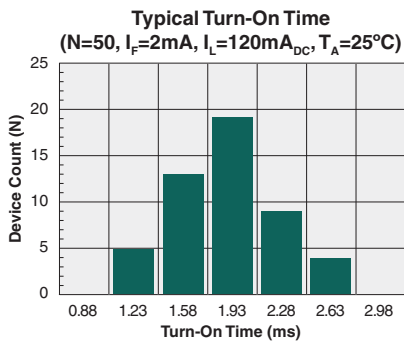

* Unless otherwise noted, data presented in these graphs is typical of device operation at 25°C.

RELAY PERFORMANCE DATA (cont)*

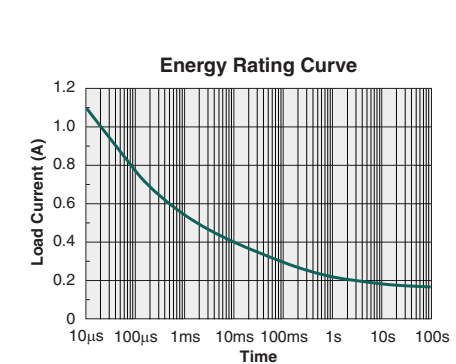
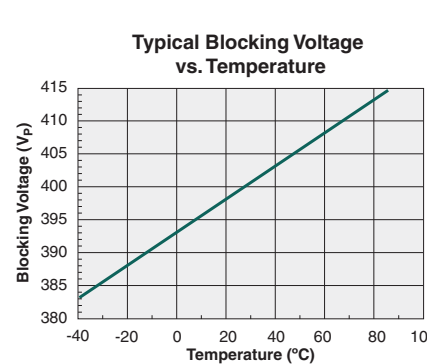
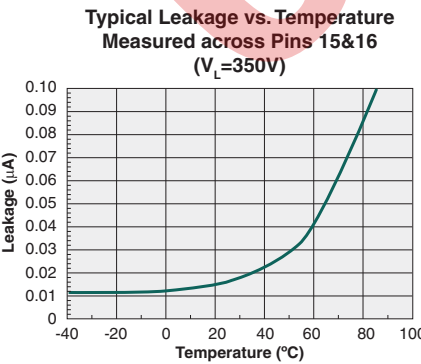
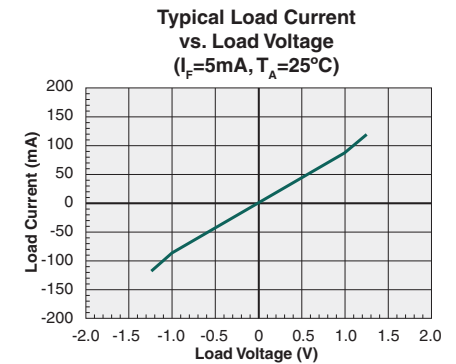
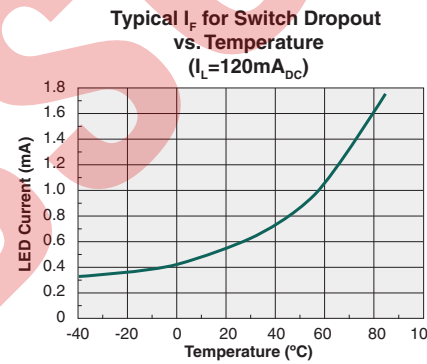
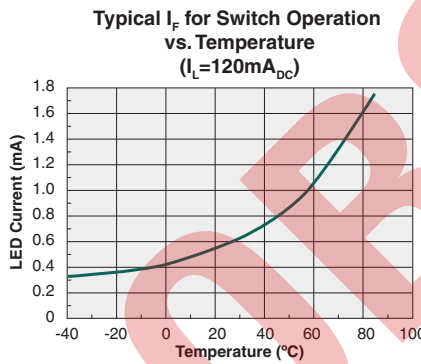
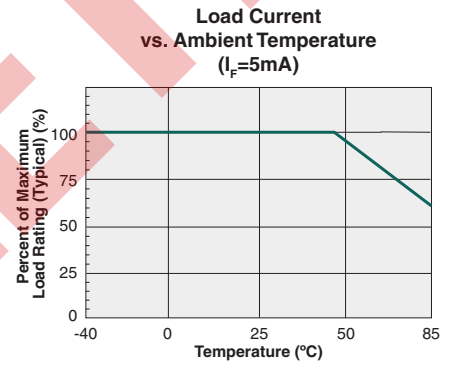
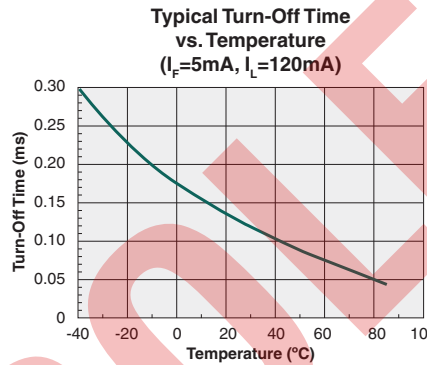
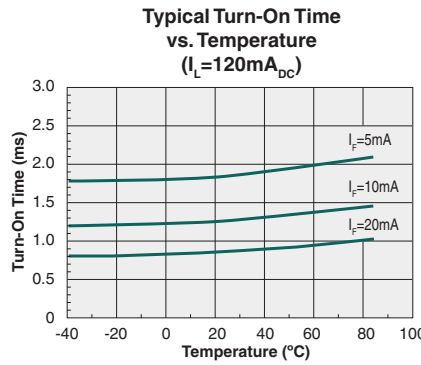
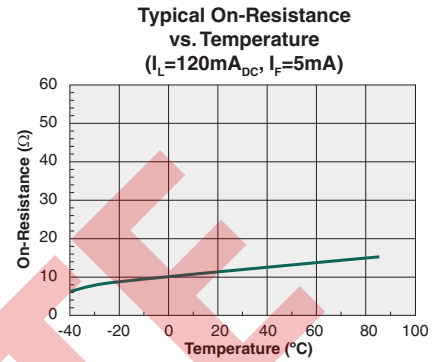
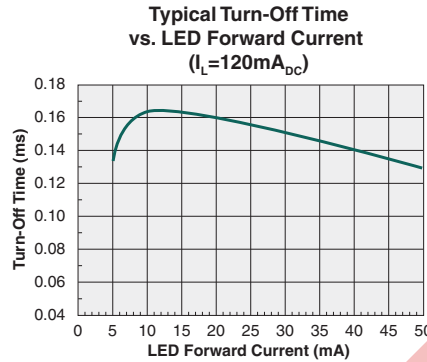
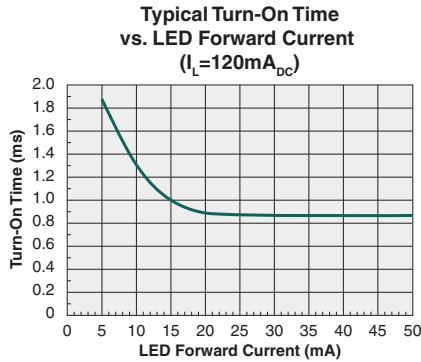

* Unless otherwise noted, data presented in these graphs is typical of device operation at 25°C.

PHOTOTRANSISTOR PERFORMANCE DATA*

Typical Transfer Characteristics of Single Transistor Detector

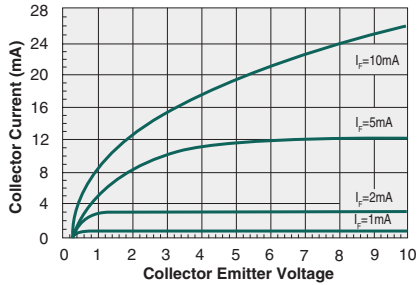

Single Transistor Normalized CTR vs. Temperature ($V_{CE}=0.5V$)

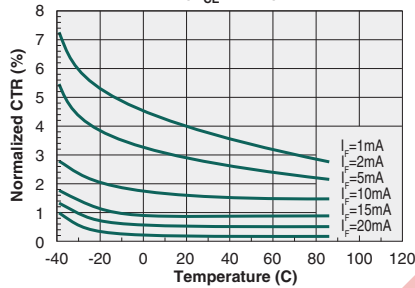

Single Transistor Normalized CTR vs. Forward Current ($V_{CE}=0.5V$)

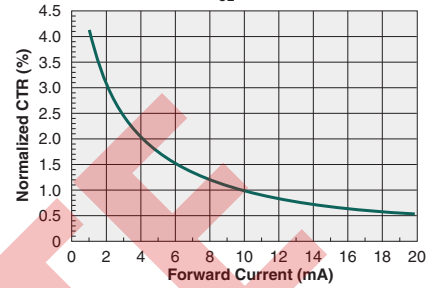

Single Transistor Collector Current vs. Forward Current ($V_{CE}=0.5V$)

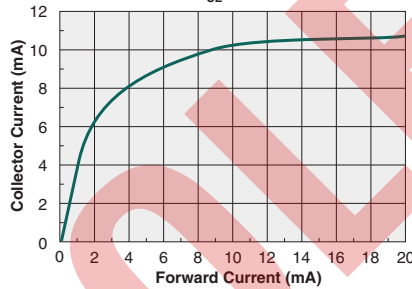

DARLINGTON PERFORMANCE DATA*

Darlington Transistor Collector Current vs. Forward Current ($V_{CE}=0.5V$)

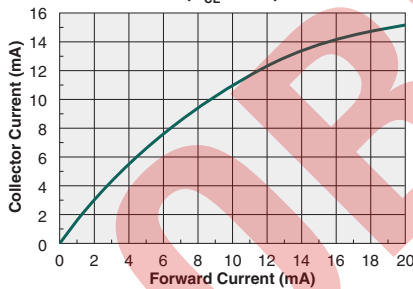

Darlington Transistor Normalized CTR vs. Forward Current ($V_{CE}=0.8V$)

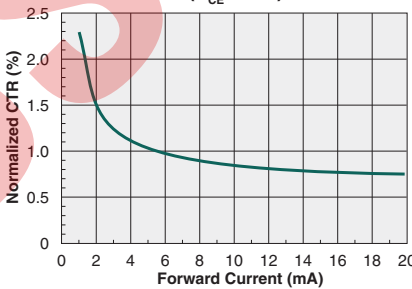

Typical Normalized CTR vs. Temperature ($V_{CE}=0.8V$)

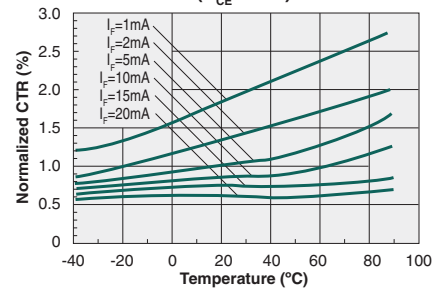

Typical Transfer Characteristics of Darlington Transistor

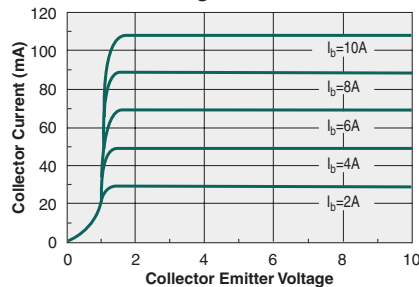

V-I Characteristics for Test Circuit

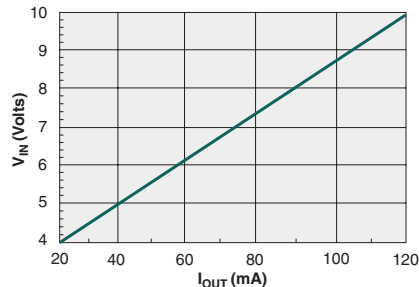

* Unless otherwise noted, data presented in these graphs is typical of device operation at 25°C.

Manufacturing Information

Moisture Sensitivity



All plastic encapsulated semiconductor packages are susceptible to moisture ingress. IXYS Integrated Circuits classifies its plastic encapsulated devices for moisture sensitivity according to the latest version of the joint industry standard, **IPC/JEDEC J-STD-020**, in force at the time of product evaluation. We test all of our products to the maximum conditions set forth in the standard, and guarantee proper operation of our devices when handled according to the limitations and information in that standard as well as to any limitations set forth in the information or standards referenced below.

Failure to adhere to the warnings or limitations as established by the listed specifications could result in reduced product performance, reduction of operable life, and/or reduction of overall reliability.

This product carries a **Moisture Sensitivity Level (MSL)** classification as shown below, and should be handled according to the requirements of the latest version of the joint industry standard **IPC/JEDEC J-STD-033**.

Device	Moisture Sensitivity Level (MSL) Classification
ITC117P	MSL 3

ESD Sensitivity



This product is ESD Sensitive, and should be handled according to the industry standard **JESD-625**.

Soldering Profile

Provided in the table below is the **IPC/JEDEC J-STD-020** Classification Temperature (T_C) and the maximum dwell time the body temperature of these surface mount devices may be ($T_C - 5$)°C or greater. The Classification Temperature sets the Maximum Body Temperature allowed for these devices during reflow soldering processes.

Device	Classification Temperature (T_C)	Dwell Time (t_p)	Max Reflow Cycles
ITC117P	245°C	30 seconds	3

Board Wash

IXYS Integrated Circuits recommends the use of no-clean flux formulations. Board washing to reduce or remove flux residue following the solder reflow process is acceptable provided proper precautions are taken to prevent damage to the device. These precautions include but are not limited to: using a low pressure wash and providing a follow up bake cycle sufficient to remove any moisture trapped within the device due to the washing process. Due to the variability of the wash parameters used to clean the board, determination of the bake temperature and duration necessary to remove the moisture trapped within the package is the responsibility of the user (assembler). Cleaning or drying methods that employ ultrasonic energy may damage the device and should not be used. Additionally, the device must not be exposed to halide flux or solvents.



MECHANICAL DIMENSIONS

ITC117P

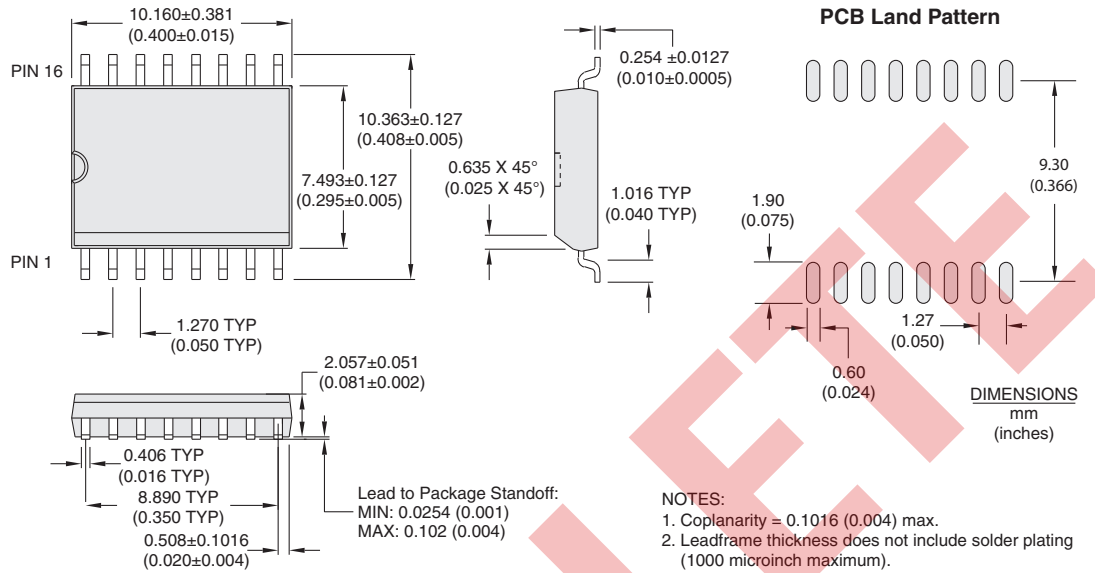

ITC117PTR Tape & Reel

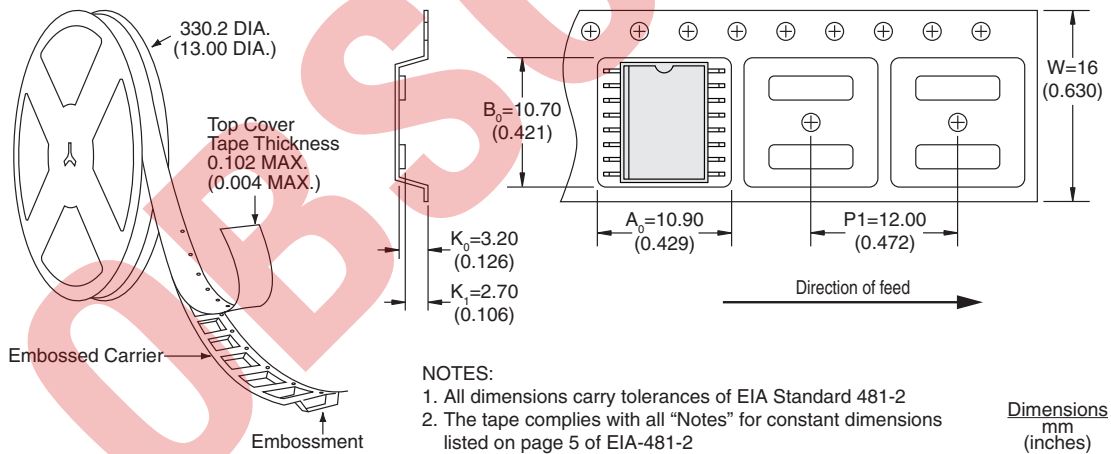

For additional information please visit our website at: <https://www.ixysic.com>