

Parameter	Rating	Units
Blocking Voltage	350	V_P
Load Current	100	mA_{rms} / mA_{DC}
On-Resistance (max)	35	Ω

Features

- 3750V_{rms} Input/Output Isolation
- Bidirectional Current Sensing
- Bidirectional Current Switching
- Replaces up to Three or Four Components
- Three Functions in One Package
- Small 16-Pin SOIC Package
- FCC Compatible
- No EMI/RFI Generation
- Tape & Reel Versions Available

Applications

- Telecommunications
 - Telecom Switching
 - Tip/Ring Circuits
 - Modem Switching (Laptop, Notebook, Pocket Size)
 - Hook Switch
 - Dial Pulsing
 - Ground Start
 - Ringing Injection
- Instrumentation
- Multiplexers
- Data Acquisition
- Electronic Switching
- I/O Subsystems
- Meters (Watt-Hour, Water, Gas)
- Medical Equipment-Patient/Equipment Isolation
- Security
- Industrial Controls

Description

The IAD110P Multifunction Telecom switch combines a 350V normally open (1-Form-A) relay and two optocouplers in a single package. The relay uses optically coupled MOSFET technology to provide 3750V_{rms} of input to output isolation. The efficient MOSFET switch and photovoltaic die use IXYS Integrated Circuits Division's patented OptoMOS® architecture. The optically coupled output is controlled by highly efficient infrared LEDs. The IAD110P enables telecom circuit designers to combine three discrete functions in a single component that uses less space than traditional discrete component solutions.

Approvals

- UL Recognized Component: File E76270
- CSA Certified Component: Certificate 1305490
- TUV EN 62368-1: Certificate B 082667 0008

Ordering Information

Part #	Description
IAD110P	16-Pin SOIC (50/Tube)
IAD110PTR	16-Pin SOIC (1000/Reel)

Pin Configuration

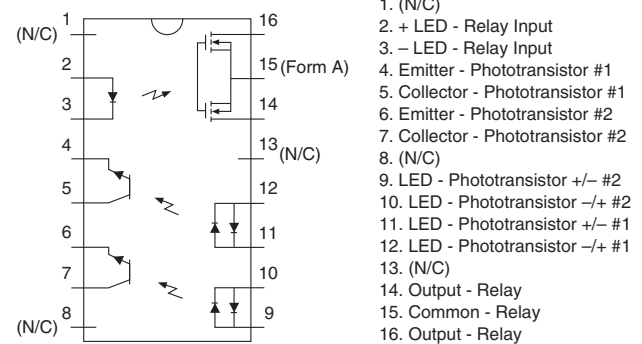

Switching Characteristics of Normally Open Devices

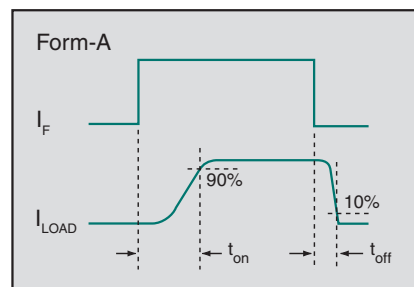

Absolute Maximum Ratings @ 25°C

Parameter	Symbol	Ratings	Units
Input Control Current, Relay	I_F	50	mA
Total Package Dissipation ¹	P_T	1	W
Isolation Voltage, Input to Output	V_{ISO}	3750	V_{rms}
Operational Temperature	T_A	-40 to +85	°C
Storage Temperature	T_{STG}	-40 to +125	°C

¹ Derate linearly 1.67 mW / °C

Absolute Maximum Ratings are stress ratings. Stresses in excess of these ratings can cause permanent damage to the device. Functional operation of the device at conditions beyond those indicated in the operational sections of this data sheet is not implied.

Typical values are characteristic of the device at +25°C, and are the result of engineering evaluations. They are provided for information purposes only, and are not part of the manufacturing testing requirements.

Electrical Characteristics @25°C: Relay Section

Parameter	Conditions	Symbol	Min	Typ	Max	Units
Output Characteristics						
Blocking Voltage (Peak)	$I_L=1\mu A$	V_L	-	-	350	V_P
Load Current						
Continuous	-	I_L	-	-	100	mA_{rms} / mA_{DC}
Peak	$t=10ms$	I_{LPK}	-	-	350	mA_P
On-Resistance	$I_L=100mA$	R_{ON}	-	-	35	Ω
Off-State Leakage Current	$V_L=350V, T_J=25^\circ C$	I_{LEAK}	-	-	1	μA
Switching Speeds						
Turn-On	$I_F=5mA, V_L=10V$	t_{on}	-	-	3	ms
Turn-Off		t_{off}	-	-	3	ms
Output Capacitance	$V_L=50V, f=1MHz$	C_{OUT}	-	25	-	pF
Input Characteristics						
Input Control Current to Activate	$I_L=100mA$	I_F	-	-	5	mA
Input Control Current to Deactivate	$I_L=1mA$	I_F	0.4	-	-	mA
Input Voltage Drop	$I_F=5mA$	V_F	0.9	1.2	1.4	V
Reverse Input Voltage	-	V_R	-	-	5	V
Reverse Input Current	$V_R=5V$	I_R	-	-	10	μA

Electrical Characteristics @25°C: Detector Section

Parameter	Conditions	Symbol	Min	Typ	Max	Units
Output Characteristics						
Phototransistor Blocking Voltage	$I_C=10\mu A$	BV_{CEO}	20	50	-	V
Phototransistor Dark Current	$V_{CE}=5V, I_F=0mA$	I_{CEO}	-	50	500	nA
Saturation Voltage	$I_C=2mA, I_F=16mA$	V_{SAT}	-	0.3	0.5	V
Current Transfer Ratio	$I_F=6mA, V_{CE}=0.5V$	CTR	33	-	-	%
Input Characteristics						
Input Control Current	$I_C=2mA, V_{CE}=0.5V$	I_F	-	2	6	mA
Input Voltage Drop	$I_F=5mA$	V_F	0.9	1.2	1.4	V
Input Current (Detector Must be Off)	$I_C=1\mu A, V_{CE}=5V$	-	5	25	-	μA
Capacitance, Input to Output	$V_L=50V, f=1MHz$	C_{IO}	-	3	-	pF
Isolation, Input to Output	-	V_{IO}	3750	-	-	V_{rms}

RELAY PERFORMANCE DATA *

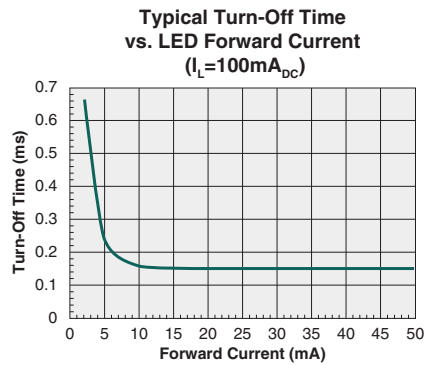
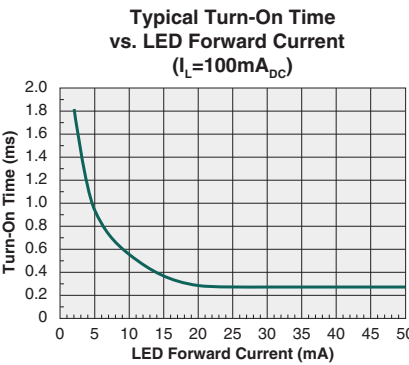
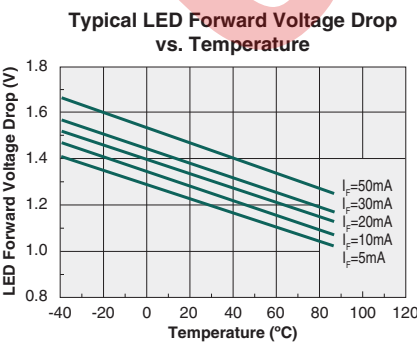
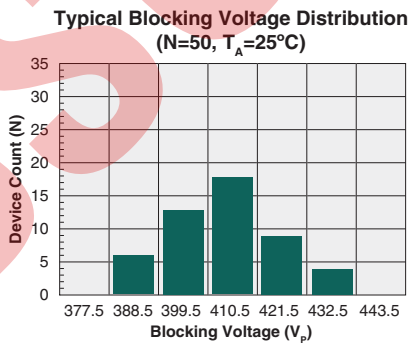
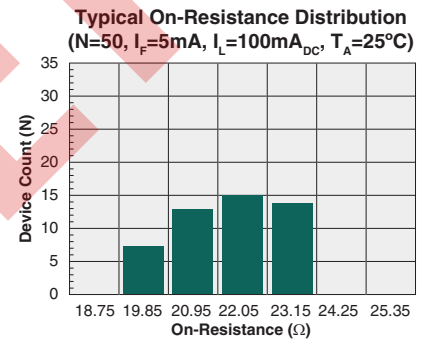
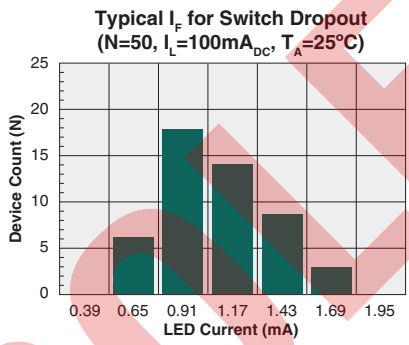
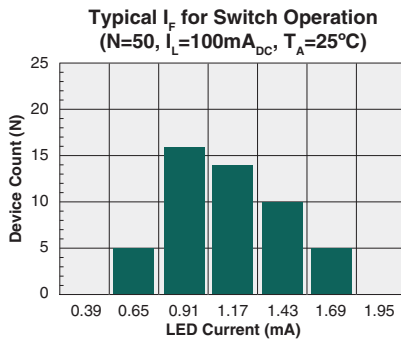
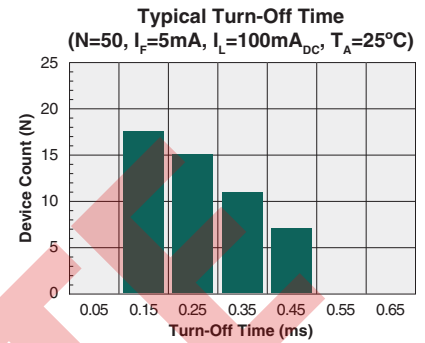
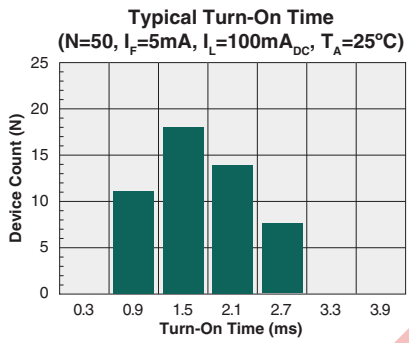
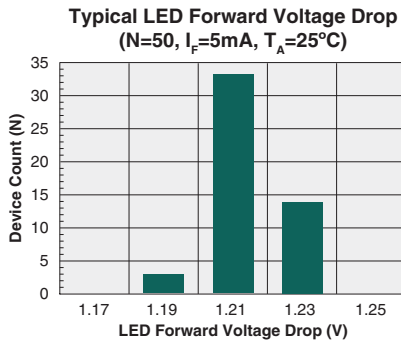

* Unless otherwise noted, data presented in these graphs is typical of device operation at 25°C.

RELAY PERFORMANCE DATA (cont.)*

Typical Turn-On Time vs. Temperature
($I_L=100\text{mA}_{DC}$)

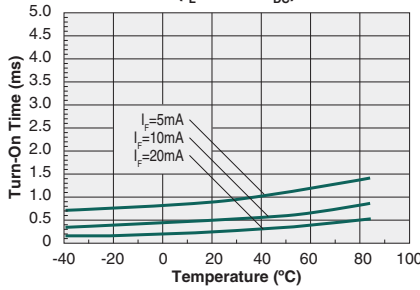

Typical Turn-Off vs. Temperature
($I_F=5\text{mA}$, $I_L=100\text{mA}_{DC}$)

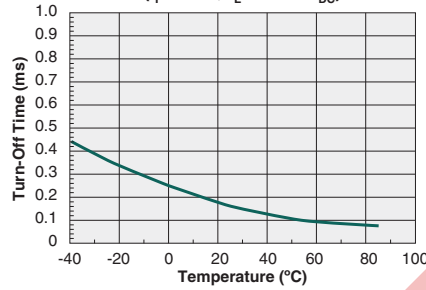

Maximum Load Current vs. Temperature

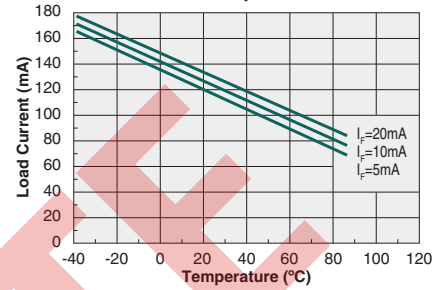

Typical I_F for Switch Operation vs. Temperature
($I_L=100\text{mA}_{DC}$)

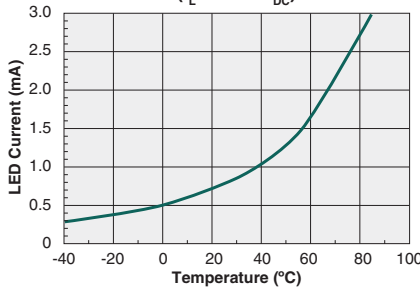

Typical I_F for Switch Dropout vs. Temperature
($I_L=100\text{mA}_{DC}$)

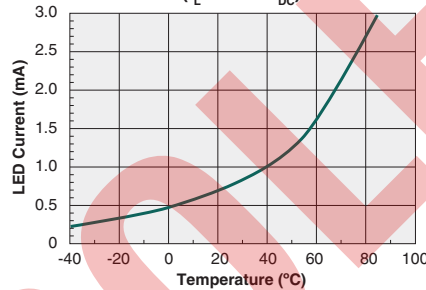

Typical On-Resistance vs. Temperature
($I_F=5\text{mA}$, $I_L=100\text{mA}_{DC}$)

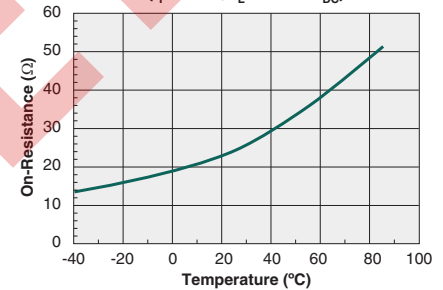

Typical Load Current vs. Load Voltage
($I_F=5\text{mA}$, $T_A=25^\circ\text{C}$)

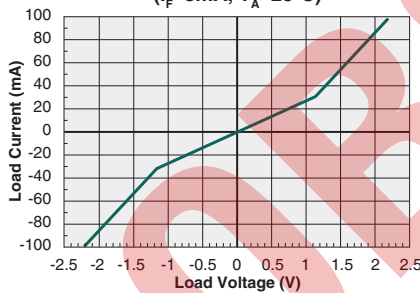

Typical Blocking Voltage vs. Temperature

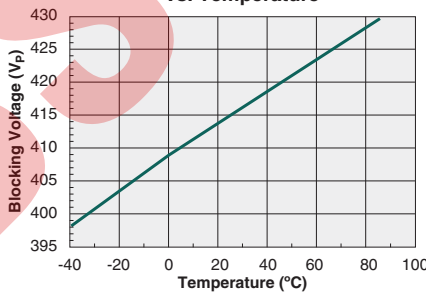

Typical Leakage vs. Temperature Measured across Pins 14&16

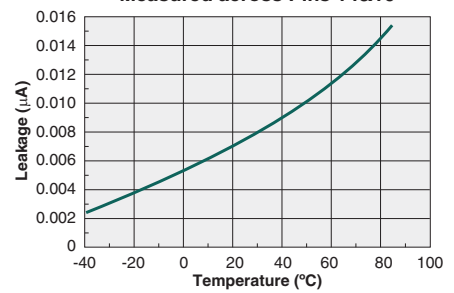

Energy Rating Curve

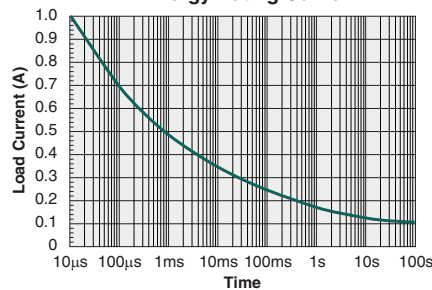

* Unless otherwise noted, data presented in these graphs is typical of device operation at 25°C.

DETECTOR PERFORMANCE DATA*

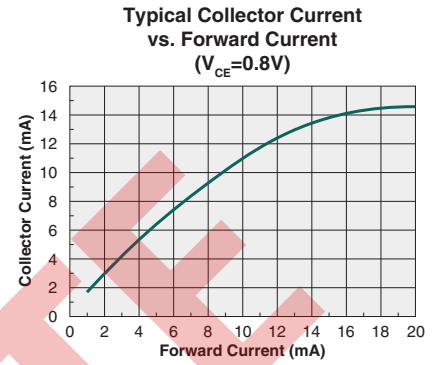
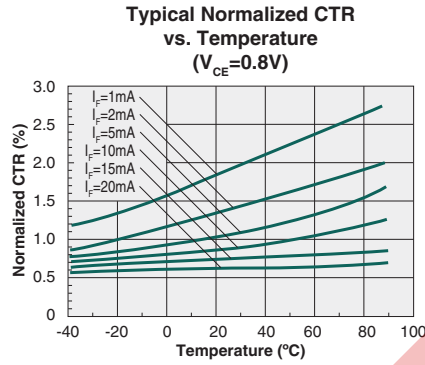
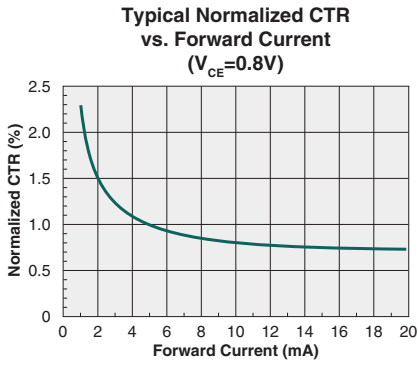

OBSOLETE

* Unless otherwise noted, data presented in these graphs is typical of device operation at 25°C.

Manufacturing Information

Moisture Sensitivity

 All plastic encapsulated semiconductor packages are susceptible to moisture ingress. IXYS Integrated Circuits classifies its plastic encapsulated devices for moisture sensitivity according to the latest version of the joint industry standard, **IPC/JEDEC J-STD-020**, in force at the time of product evaluation. We test all of our products to the maximum conditions set forth in the standard, and guarantee proper operation of our devices when handled according to the limitations and information in that standard as well as to any limitations set forth in the information or standards referenced below.

Failure to adhere to the warnings or limitations as established by the listed specifications could result in reduced product performance, reduction of operable life, and/or reduction of overall reliability.

This product carries a **Moisture Sensitivity Level (MSL)** classification as shown below, and should be handled according to the requirements of the latest version of the joint industry standard **IPC/JEDEC J-STD-033**.

Device	Moisture Sensitivity Level (MSL) Classification
IAD110P	MSL 3

ESD Sensitivity

 This product is ESD Sensitive, and should be handled according to the industry standard **JESD-625**.

Soldering Profile

Provided in the table below is the **IPC/JEDEC J-STD-020** Classification Temperature (T_C) and the maximum dwell time the body temperature of these surface mount devices may be ($T_C - 5$)°C or greater. The Classification Temperature sets the Maximum Body Temperature allowed for these devices during reflow soldering processes.

Device	Classification Temperature (T_C)	Dwell Time (t_p)	Max Reflow Cycles
IAD110P	245°C	30 seconds	3

Board Wash

IXYS Integrated Circuits recommends the use of no-clean flux formulations. Board washing to reduce or remove flux residue following the solder reflow process is acceptable provided proper precautions are taken to prevent damage to the device. These precautions include but are not limited to: using a low pressure wash and providing a follow up bake cycle sufficient to remove any moisture trapped within the device due to the washing process. Due to the variability of the wash parameters used to clean the board, determination of the bake temperature and duration necessary to remove the moisture trapped within the package is the responsibility of the user (assembler). Cleaning or drying methods that employ ultrasonic energy may damage the device and should not be used. Additionally, the device must not be exposed to halide flux or solvents.



MECHANICAL DIMENSIONS

IAD110P

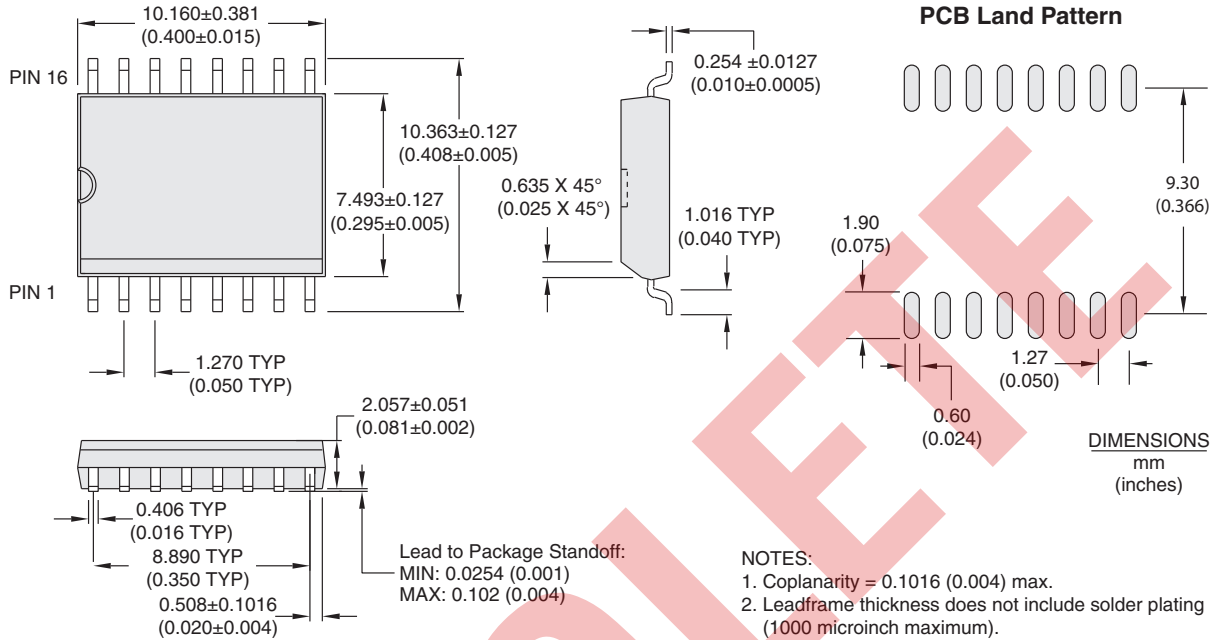

IAD110PTR Tape & Reel

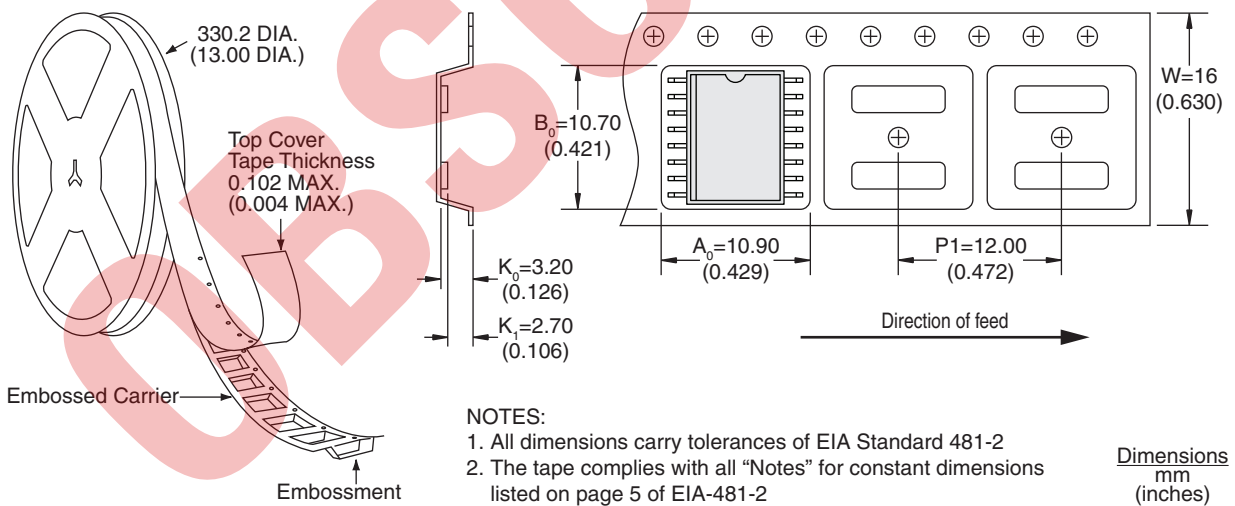

For additional information please visit our website at: <https://www.ixysic.com>