

DSEP60-06AZ

600 V, 60 A High Performance Fast Recovery Diode

Low Loss and Soft Recovery Single Diode

RoHS

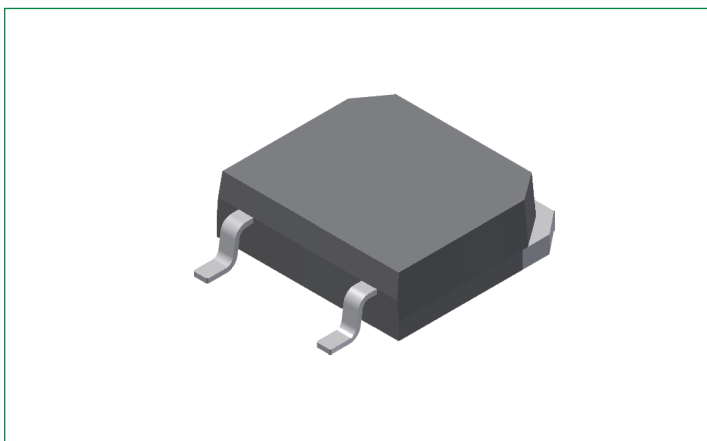

Features:

- Planar passivated chips
- Very low leakage current
- Short recovery time
- Soft recovery behavior
- Low I_{RM} values
- Avalanche voltage rated for reliable operation
- Soft reverse recovery for low EMI/RFI

Benefits:

- Low I_{RM} reduces power dissipation within the diode and turn-on loss in the commutating switch
- Improved thermal behavior

Applications:

- Antiparallel diode for high frequency switching devices
- Antisaturation diode
- Snubber diode
- Freewheeling diode
- Rectifiers in Switch Mode Power Supplies (SMPS)
- Uninterruptible power supplies (UPS)

Package:

- RoHS compliant
- Epoxy meets UL 94V-0
- Industry standard outline

Product Summary

Characteristic	Value	Unit
V_{RRM}	600	V
I_{FAV}	60	A
t_{rr}	35	ns

Pinout Diagram TO-268AA (D³PAK-HV)

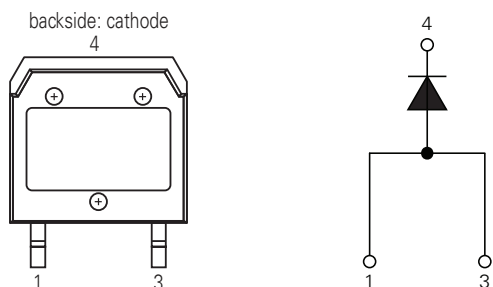

1: Anode; 3: Anode; 4: Cathode

Maximum Ratings

Symbol	Characteristics	Conditions	Value	Units
V_{RRM}	Repetitive Reverse Blocking Voltage	$T_{vj} = 25\text{ °C}$	600	V
I_{FAV}	Average Forward Current	$T_C = 130\text{ °C}$, $T_{vj} = 175\text{ °C}$; rectangular d = 0.5	60	A
I_{FSM}	Forward Surge Current	t = 10 ms; (50 Hz), sine; $V_R = 0\text{ V}$, $T_{vj} = 45\text{ °C}$	600	A
T_{stg}	Storage Temperature Range	–	–55 to +150	°C
T_{vj}	Virtual Junction Temperature Range	–	–55 to +175	°C
T_{OP}	Operating Temperature Range	–	–55 to +150	°C
P_{tot}	Total Power Dissipation	$T_C = 25\text{ °C}$	330	W

Thermal Specifications

Symbol	Characteristic	Value			Units
		Min.	Typ.	Max.	
R_{thJC}	Thermal Resistance, Junction to Case	–	–	0.45	K/W
R_{thCH}	Thermal Resistance, Case to Heatsink	–	0.15	–	K/W

Electrical Characteristics – Static

Symbol	Characteristics	Conditions	Value			Units		
			Min.	Typ.	Max.			
I_R	Reverse Leakage Current	$T_{vj} = 25\text{ °C}$	$V_R = 600\text{ V}$	–	–	650	μA	
		$T_{vj} = 150\text{ °C}$		–	–	2.5	mA	
V_F	Forward Voltage	$T_{vj} = 25\text{ °C}$	$I_F = 60\text{ A}$	–	–	2.04	V	
				$I_F = 120\text{ A}$	–	–		2.33
		$T_{vj} = 150\text{ °C}$		$I_F = 60\text{ A}$	–	–		1.39
				$I_F = 120\text{ A}$	–	–		1.70
V_{FO}	Threshold Voltage	$T_{vj} = 175\text{ °C}$	–	–	0.95	V		
r_F	Slope Resistance	$T_{vj} = 175\text{ °C}$	–	–	5	mΩ		
C_J	Junction Capacitance	$V_R = 400\text{ V}$; f = 1 MHz	–	67	–	pF		

Electrical Characteristics – Dynamic

Symbol	Characteristics	Conditions	Value			Units	
			Min.	Typ.	Max.		
I_{RM}	Reverse Recovery Current	$T_{vj} = 25\text{ °C}$	$I_F = 60\text{ A}$; $V_R = 300\text{ V}$; -di/dt = 200 A/μs	–	8	–	A
		$T_{vj} = 100\text{ °C}$		–	13	–	
t_{rr}	Reverse Recovery Time	$T_{vj} = 25\text{ °C}$		–	35	–	ns
		$T_{vj} = 100\text{ °C}$		–	110	–	

Package TO-268AA (D³PAK-HV)

Symbol	Characteristics	Conditions	Value			Units
			Min.	Typ.	Max.	
I_{RMS}	RMS Current	per terminal	–	–	70	A
F_C	Mounting Force with Clip	–	20	–	120	N
G	Weight	–	–	4	–	g
$d_{Spp/App}$	Creepage Distance on Surface/ Striking Distance through Air	terminal to terminal	9.4	–	–	mm
$d_{Spb/Apb}$		terminal to backside	5.6	–	–	mm

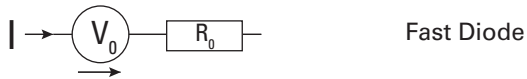
Equivalent Circuits for Simulation ($T_{vj} = 175\text{ }^{\circ}\text{C}$)

Symbol	Characteristics	Value	Units
$V_{0\text{ max}}$	Threshold Voltage	0.95	V
$R_{0\text{ max}}$	Slope Resistance ¹	2.4	mΩ

Note 1: On die level

Characteristic Curves

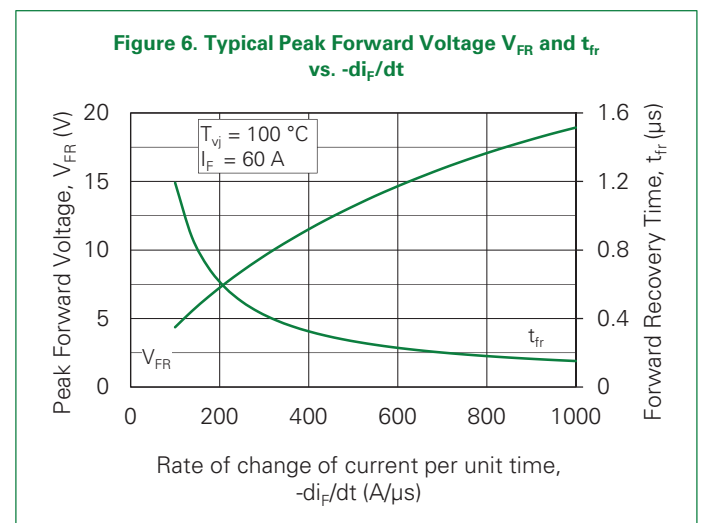
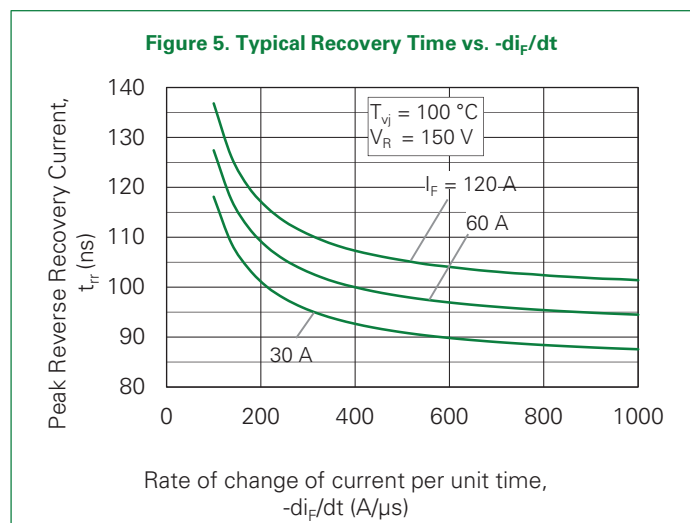
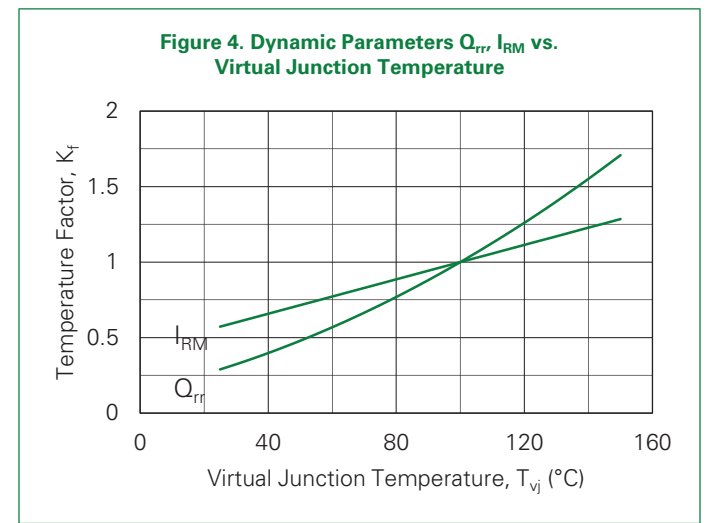
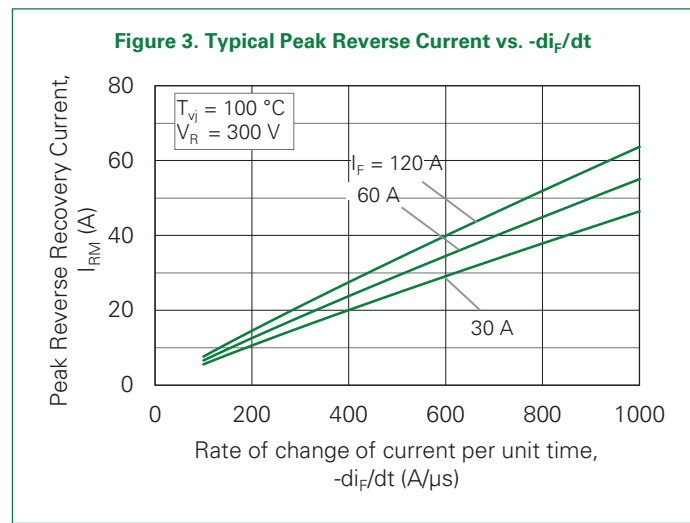
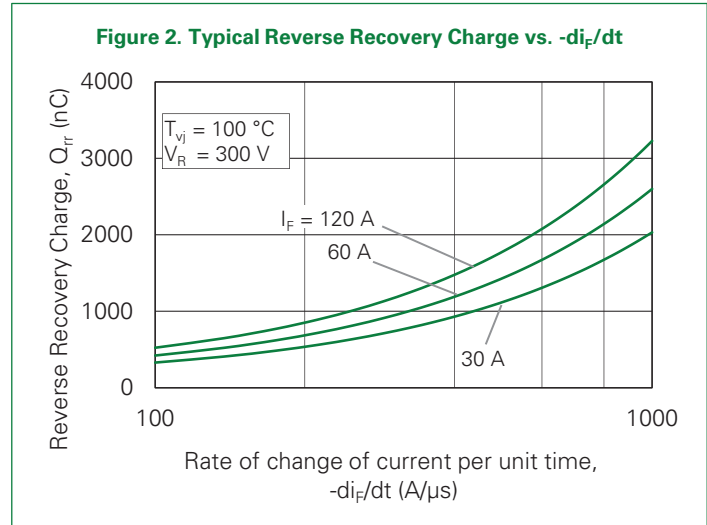
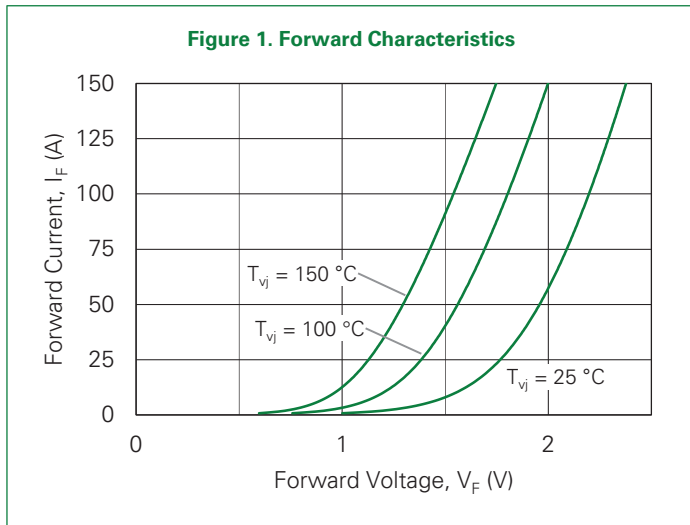
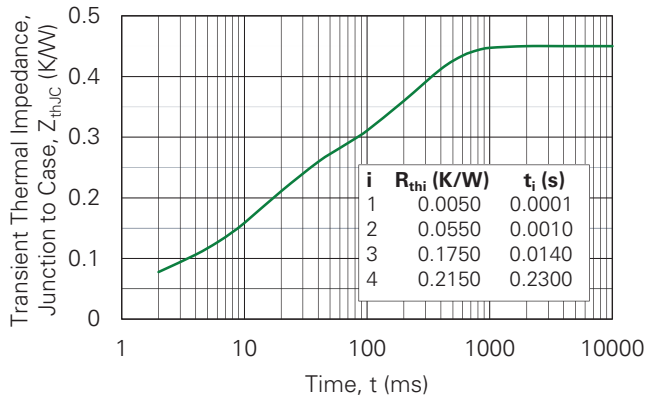
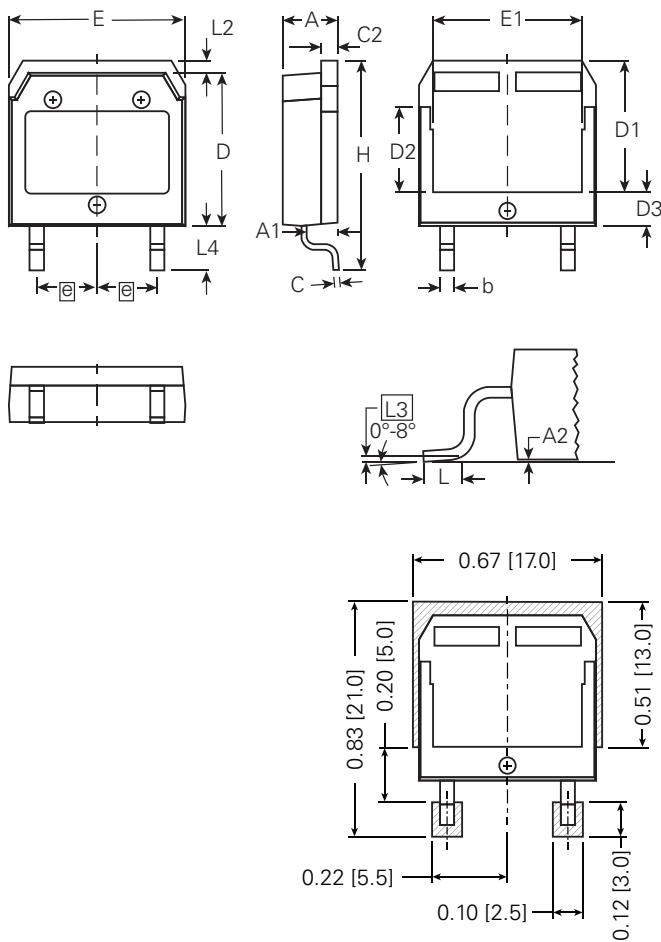

Figure 7. Transient Thermal Impedance, Junction to Case



Part Outline Drawing TO-268AA (D³PAK-HV)



Symbol	Millimeters		Inches	
	Min.	Max.	Min.	Max.
A	4.90	5.10	0.193	0.201
A1	2.70	2.90	0.106	0.114
A2	0.02	0.25	0.001	0.010
b	1.15	1.45	0.045	0.057
C	0.40	0.65	0.016	0.026
C2	1.45	1.60	0.057	0.063
D	13.80	14.00	0.543	0.551
D1	11.80	12.10	0.465	0.476
D2	7.50	7.80	0.295	0.307
D3	2.90	3.20	0.114	0.126
E	15.85	16.05	0.624	0.632
E1	13.30	13.60	0.524	0.535
e	5.450 BSC		0.215 BSC	
H	18.70	19.10	0.736	0.752
L	1.70	2.00	0.067	0.079
L2	1.00	1.15	0.039	0.045
L3	0.250 BSC		0.010 BSC	
L4	3.80	4.10	0.150	0.161

Part Numbering and Marking

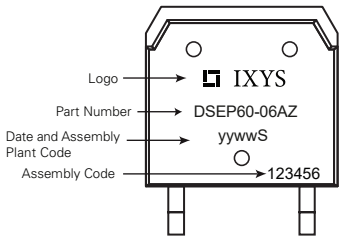

- DS = Diode
- E = Fast Recovery Diode
- P = HiPerFRED
- 60 = Current Rating (A)
- 06 = Reverse Voltage (600 V)
- AZ = Package (TO-268 HV)

Packing Options

Part Number	Marking	Packing Mode	Quantity
DSEP60-06AZ-TUB	DSEP60-06AZ	Tube	30 pcs
DSEP60-06AZ-TRL	DSEP60-06AZ	Tape & Reel	400 pcs

Disclaimer Notice

Information furnished is believed to be accurate and reliable. However, users should independently evaluate the suitability of and test each product selected for their own applications. Littelfuse products are not designed for, and may not be used in, all applications. Read complete Disclaimer Notice at <http://www.littelfuse.com/disclaimer-electronics>.



Part of:

