



Parameter	Rating	Units
Blocking Voltage	60	V _P
Load Current (T _A ≤ 60°C)	1	A _{DC} /A _{rms}
Input Control Current	2.5	mA
On-Resistance (max)	245	mΩ

Features

- 1A_{DC}/A_{rms} to 60°C
- 60V blocking voltage
- Highly robust switching relay
 - Integrated active current-limit protection
 - Thermal shutdown
- Auto-recovery following fault removal
- Low input control current: 2.5mA
- Linear AC or DC operation
- Low power consumption
- Clean, bounce-free switching
- Low power drive requirements
- Flammability rating UL 94 V-0

Applications

- 16-24V AC Systems
- Security Systems
- Residence and Building Controls
- Gaming
- Instrumentation
- Battery Powered Systems

Approvals

- UL 1577 Recognized Component: File Pending

Description

CPC1561B is a single-pole, normally open (1-Form-A) optically isolated Solid State Relay with integrated current limit and thermal shutdown features. The current limit remains flat over the operating temperature range. Perfect for replacing electromechanical relays while enhancing the robustness of applications. The CPC1561B can switch 1A_{DC} or 1A_{rms} loads up to 60°C.

The relay is constructed using an efficient LED and a photodiode array die for actuation control and an integrated monolithic die for the switch output. The protected switch die, fabricated in a high voltage dielectrically isolated technology, comprises switch control, active current limiting, and thermal shutdown circuitry with the MOSFET switches.

CPC1561B incorporates thermal shutdown circuitry for improved survivability in harsh environments, and is designed to pass regulatory voltage surge requirements when provided with appropriate over-voltage protection circuitry.

Designed specifically for environmentally demanding AC or DC applications the CPC1561B is an ideal solution.

Ordering Information

Part	Description
CPC1561B	16-Pin SOIC, Surface Mount in tubes (50/Tube)
CPC1561BTR	16-Pin SOIC, Surface Mount in Tape & Reel (1000/Reel)

Block Diagram

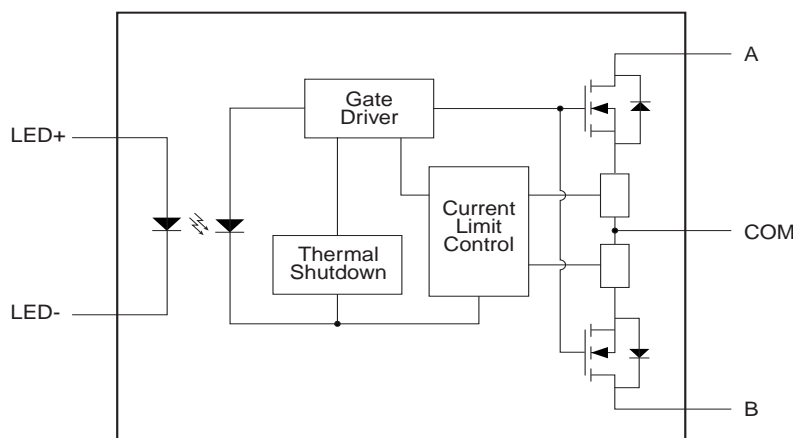

1. Specifications	3
1.1 Package Pinout	3
1.2 Pin Description	3
1.3 Absolute Maximum Ratings	3
1.4 Electrical Characteristics	4
1.5 Thermal Characteristics	4
1.6 Timing Diagram	4
2. Performance Data	5
3. Manufacturing Information	8
3.1 Moisture Sensitivity	8
3.2 ESD Sensitivity	8
3.3 Soldering Profile	8
3.4 Board Wash	8
3.5 Mechanical Information	9

1. Specifications

1.1 Package Pinout

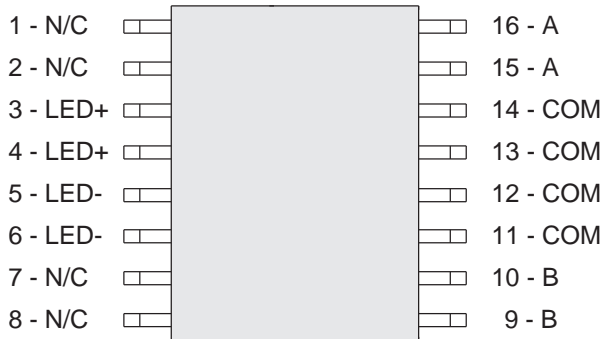

1.2 Pin Description

Pin #	Symbol	Description
1, 2	-	Not connected
3, 4	LED+	Positive input to LED (internally connected)
5, 6	LED-	Negative input to LED (internally connected)
7, 8	-	Not connected
9, 10	B	Switch terminal B (AC/DC)
11, 12, 13, 14	COM	For thermal dissipation to PCB, not for current carrying (internally connected)
15, 16	A	Switch terminal A (AC/DC)

1.3 Absolute Maximum Ratings

Parameter	Symbol	Rating	Unit
Blocking Voltage	V_{DRM}	60	V_P
Reverse Input Voltage	V_R	5	V
Input Control Current, Continuous	I_F	20	mA
Peak (10ms)		1	A
Input Power Dissipation ¹ ($T \leq 60^\circ C$)	P_{IN}	50	mW
Output Power Dissipation ² ($T \leq 60^\circ C$)	P_{OUT}	1.25	W
Total Power Dissipation ³ ($T \leq 60^\circ C$)	P_T	1.3	W
ESD, Human Body Model	-	3	kV
Isolation Voltage (Input to Output)	V_{ISO}	3750	V_{rms}
Operating Temperature	T_A	-40 to +85	$^\circ C$
Storage Temperature	-	-40 to +125	$^\circ C$

¹ Derate input linearly by 1.33 mW/ $^\circ C$ above 60 $^\circ C$.

² Derate output linearly by 10 mW/ $^\circ C$ above 60 $^\circ C$.

³ The sum of the input and output power dissipation values must not exceed the package total power dissipation rating.

Absolute maximum electrical ratings are at 25 $^\circ C$, unless otherwise specified.

Absolute maximum ratings are stress ratings. Stresses in excess of these ratings can cause permanent damage to the device. Functional operation of the device at conditions beyond those indicated in the operational sections of this data sheet is not implied.

1.4 Electrical Characteristics

Unless otherwise specified, minimum and maximum values are guaranteed by production testing at 25°C only.

Typical values are characteristic of the device at 25°C and are the result of engineering evaluations. They are provided for informational purposes only and are not part of the manufacturing testing requirements.

Parameter	Conditions	Symbol	Min	Typ	Max	Units
Output Characteristics						
Blocking Voltage	$I_F=0\text{mA}$ or $V_F=0\text{V}$, $I_L=1\mu\text{A}$	V_{DRM}	60	-	-	V_P
Load Current, Continuous ¹	$T_A \leq 60^\circ\text{C}$	I_L	-	-	1	A
Current Limit	$I_F=5\text{mA}$, $V_L=\pm 4\text{V}$, $t=2\text{ms}$	I_{LMT}	1.56	2.1	3	A
On-Resistance ²	$I_F=5\text{mA}$, $I_L=100\text{mA}$	R_{ON}	-	193	245	$\text{m}\Omega$
Off-State Leakage Current	$V_L=60\text{V}$	I_{LEAK}	-	-	1	μA
Switching Speeds	$I_F=5\text{mA}$, $I_L=100\text{mA}$, $V_L=10\text{V}$	t_{on} t_{off}	-	1.2	2.5	ms
Turn-On				0.06	0.5	
Turn-Off						
Output Capacitance	$I_F=0\text{mA}$, $V_L=1V_{\text{DC}}$, $f=1\text{MHz}$	C_O	-	170	-	pF
Input Characteristics						
Input Control Current to Activate ³	$I_L=100\text{mA}$	I_F	-	0.65	2.5	mA
Input Voltage to Deactivate	$I_L=1\mu\text{A}$	V_F	0.8	-	-	V
Reverse Input Current	$V_F=-5\text{V}$	I_R	-	-	10	μA
LED Forward Voltage	$I_F=5\text{mA}$	V_F	0.9	1.22	1.5	V
Common Characteristics						
Input to Output Capacitance	$V_{\text{IO}}=0V_{\text{DC}}$, $f=1\text{MHz}$	C_{IO}	-	1	-	pF
Thermal Characteristics						
Thermal Impedance, Junction to Ambient	-	Θ_{JA}	-	100	-	$^\circ\text{C}/\text{W}$
Thermal Shutdown	-	T_{SD}	-	128	-	$^\circ\text{C}$

¹ For applications requiring operation at high temperature (greater than 60°C) derate the load current by 12mA/°C.

² Measurement taken within 1 second of on time.

³ For applications requiring operation at high temperature (greater than 60°C) or in noisy environments a minimum LED drive current of 5mA is recommended.

1.5 Thermal Characteristics

Parameter	Conditions	Symbol	Min	Typ	Max	Units
Thermal Characteristics						
Thermal Impedance, Junction to Ambient	Based on use of the land pattern shown in Section 3.5.1	Θ_{JA}	-	100	-	$^\circ\text{C}/\text{W}$
Thermal Shutdown	-	T_{SD}	-	128	-	$^\circ\text{C}$

1.6 Timing Diagram

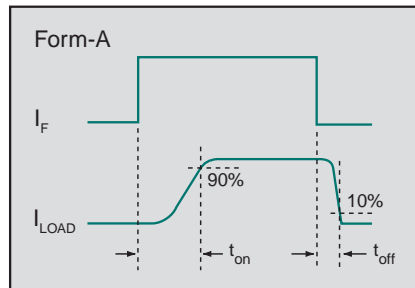

2. Performance Data

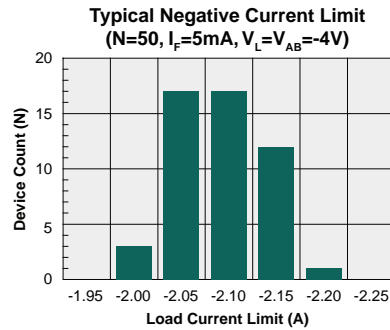
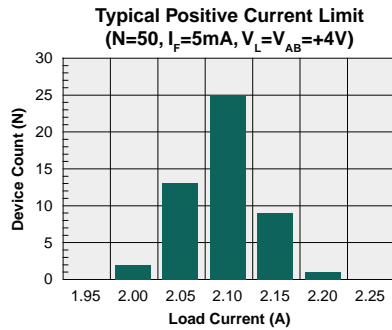
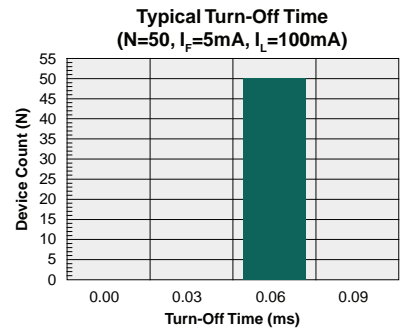
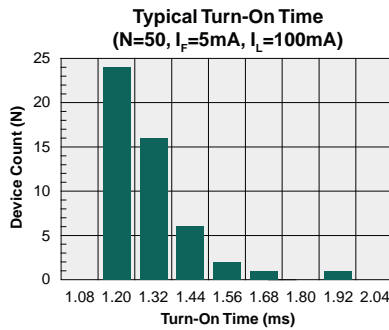
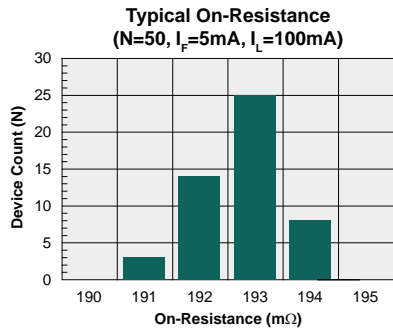
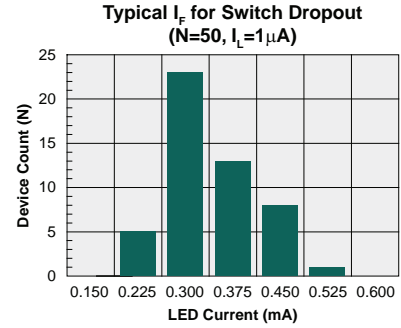
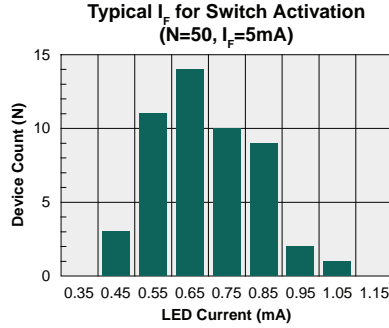
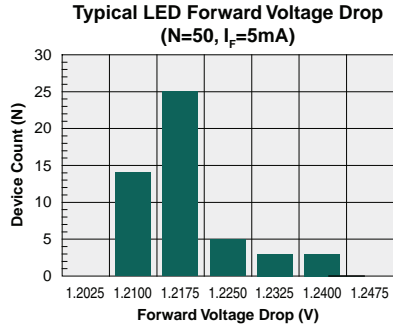

*Unless otherwise noted, data presented in these graphs is typical of device operation at 25°C.

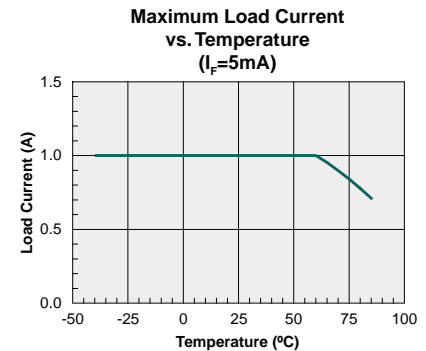
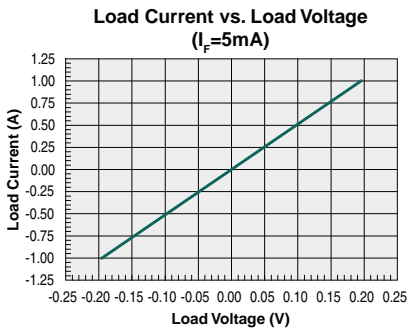
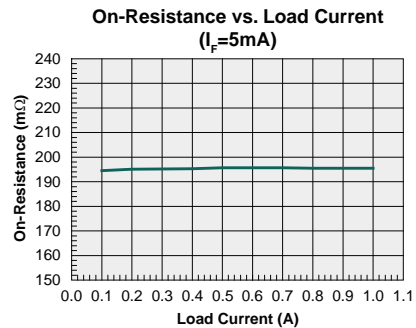
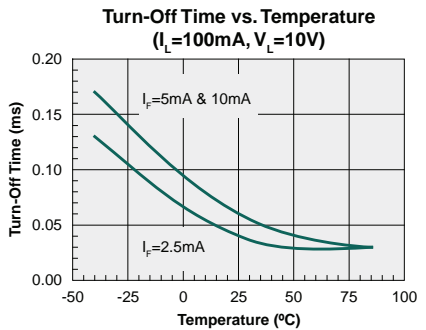
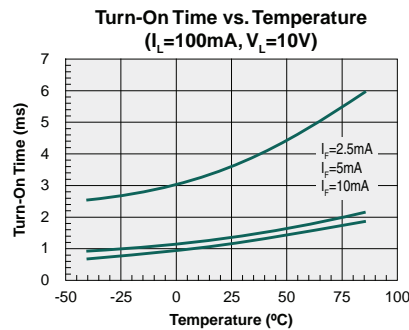
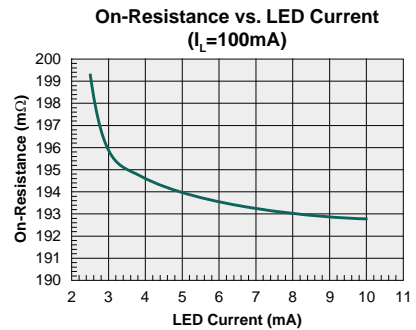
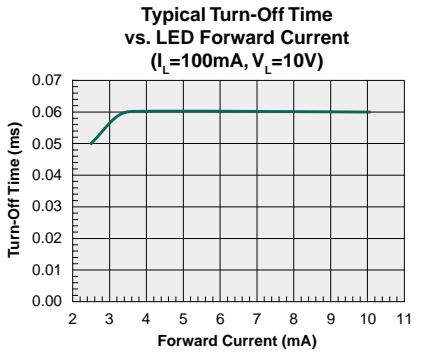
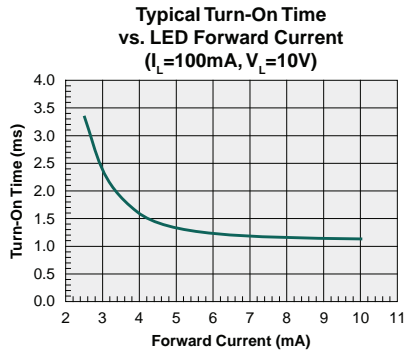
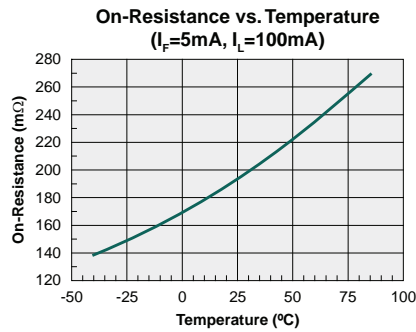
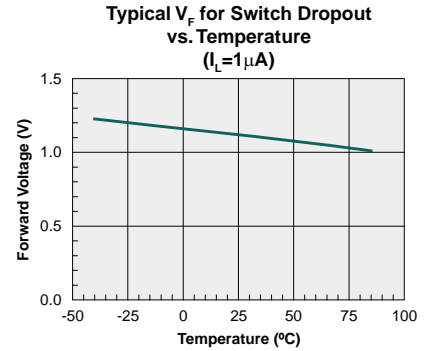
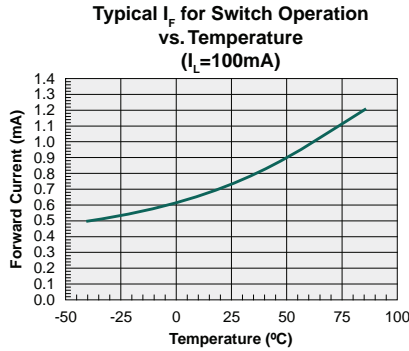
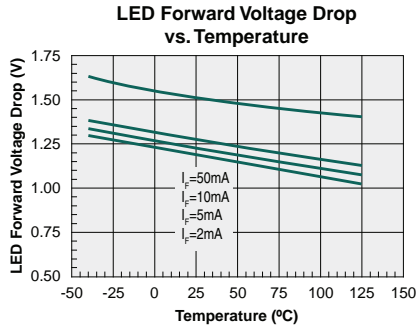

*Unless otherwise noted, data presented in these graphs is typical of device operation at 25°C.

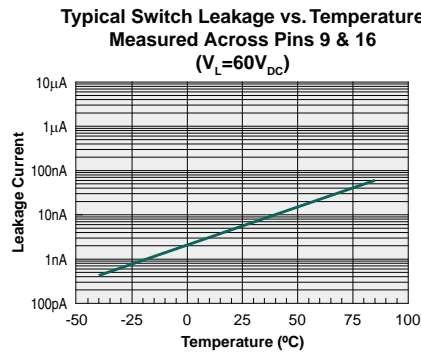
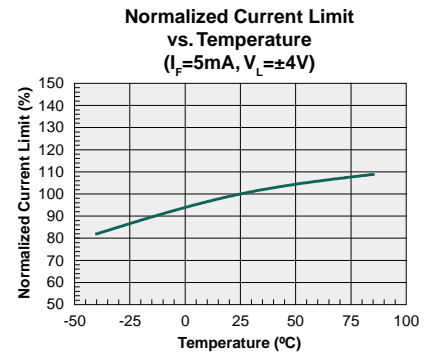
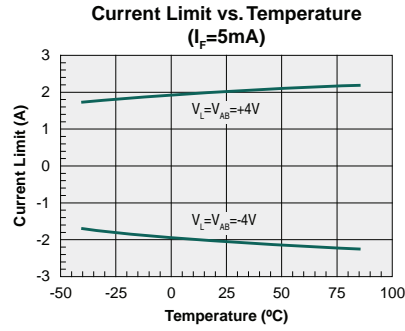
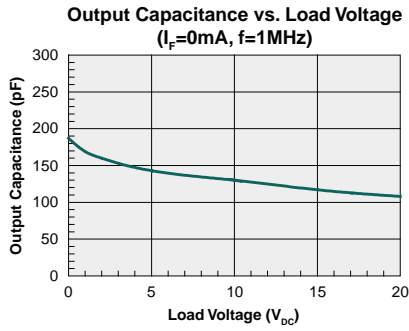

*Unless otherwise noted, data presented in these graphs is typical of device operation at 25°C.

3 Manufacturing Information

3.1 Moisture Sensitivity



All plastic encapsulated semiconductor packages are susceptible to moisture ingress. IXYS Integrated Circuits classifies its plastic encapsulated devices for moisture sensitivity according to the latest version of the joint industry standard, **IPC/JEDEC J-STD-020**, in force at the time of product evaluation. We test all of our products to the maximum conditions set forth in the standard, and guarantee proper operation of our devices when handled according to the limitations and information in that standard as well as to any limitations set forth in the information or standards referenced below.

Failure to adhere to the warnings or limitations as established by the listed specifications could result in reduced product performance, reduction of operable life, and/or reduction of overall reliability.

This product carries a **Moisture Sensitivity Level (MSL)** classification as shown below, and should be handled according to the requirements of the latest version of the joint industry standard **IPC/JEDEC J-STD-033**.

Device	Moisture Sensitivity Level (MSL) Classification
CPC1561B	MSL 3

3.2 ESD Sensitivity



This product is **ESD Sensitive**, and should be handled according to the industry standard **JESD-625**.

3.3 Soldering Profile

Provided in the table below is the **IPC/JEDEC J-STD-020** Classification Temperature (T_C) and the maximum dwell time the body temperature of these surface mount devices may be ($T_C - 5$)°C or greater. The Classification Temperature sets the Maximum Body Temperature allowed for these devices during reflow soldering processes.

Device	Classification Temperature (T_C)	Dwell Time (t_p)	Max Reflow Cycles
CPC1561B	260°C	30 seconds	3

3.4 Board Wash

IXYS Integrated Circuits recommends the use of no-clean flux formulations. Board washing to reduce or remove flux residue following the solder reflow process is acceptable provided proper precautions are taken to prevent damage to the device. These precautions include but are not limited to: using a low pressure wash and providing a follow up bake cycle sufficient to remove any moisture trapped within the device due to the washing process. Due to the variability of the wash parameters used to clean the board, determination of the bake temperature and duration necessary to remove the moisture trapped within the package is the responsibility of the user (assembler). Cleaning or drying methods that employ ultrasonic energy may damage the device and should not be used. Additionally, the device must not be exposed to halide flux or solvents.



3.5 Mechanical Information

3.5.1 CPC1561B 16-pin SOIC Package Dimensions

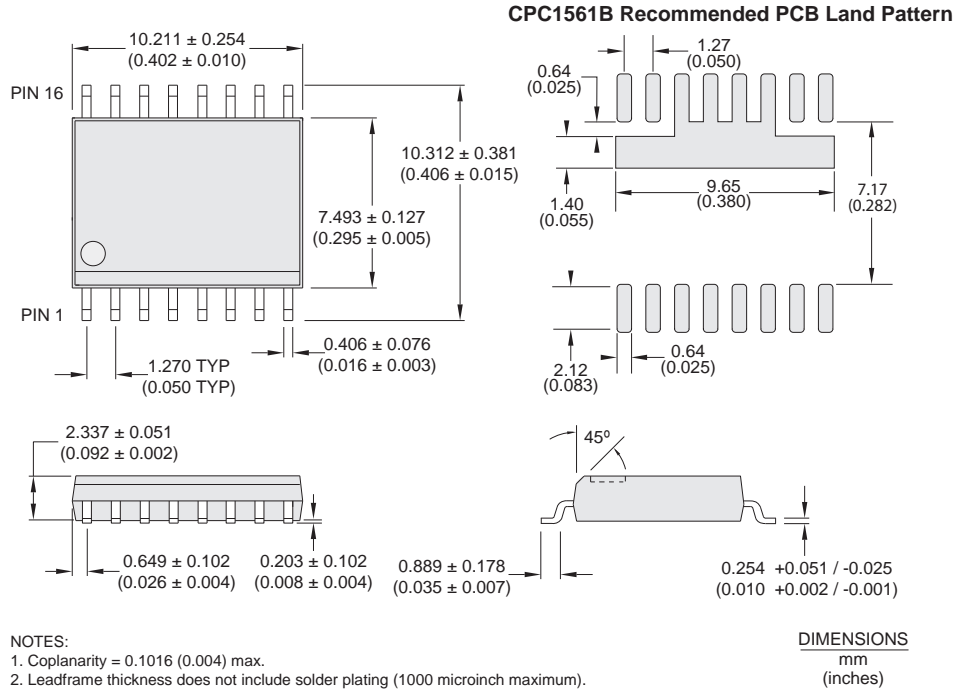

3.5.2 CPC1561B Tape & Reel Dimensions

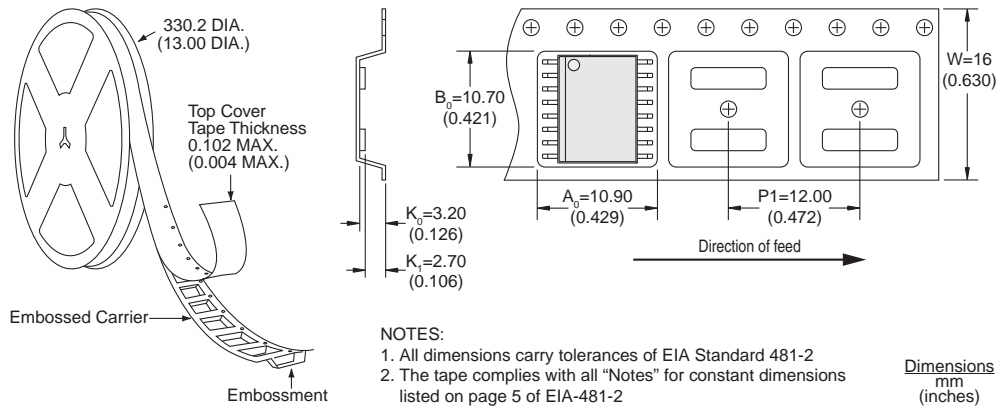

For additional information please visit our website at: www.ixysic.com