

Parameters	Ratings	Units
Load Voltage, AC/DC	350	$V_P$
Load Current	100	$mA_{rms} / mA_{DC}$
On-Resistance (max)	35	$\Omega$
LED Current to Operate	1	mA

### Transient Protection Characteristics

Peak Pulse Power	$V_{RWM}$
600W	40.2V

### Features

- Meets Requirements of EN50130-4 (Installation Class 3)
- 3750V<sub>rms</sub> Input/Output Isolation
- 100% Solid State
- Low Drive Power Requirements
- Greater Reliability than Electromechanical Relays
- No EMI/RFI Generation
- Flammability Rating UL 94 V-0

### Applications

- Security
- Sensor Circuitry
- Instrumentation
- Multiplexers
- Data Acquisition
- Electronic Switching
- I/O Subsystems
- Industrial Controls

### Description

The CPC1335P is a single-pole, normally open (1-Form-A) solid state relay with bi-directional transient voltage suppressor (TVS) relay protection designed to meet the requirements of EN50130-4 (installation class 3).

The relay output is constructed with efficient MOSFET switches that use Littelfuse IXYS Integrated Circuits' patented OptoMOS architecture. The input, a highly efficient infrared LED, controls the optically coupled output.

The CPC1335P is available in a space-saving 8-pin SOIC package.

### Approvals

- UL Recognized Component: File E76270
- EN 62368-1: TUV Certificate # B 082667 0008

### Ordering Information

Part #	Description
CPC1335P	8-Pin SOIC (Flatpack) (50/Tube)
CPC1335PTR	8-Pin SOIC (Flatpack) (1000/Reel)

### Pin Configuration

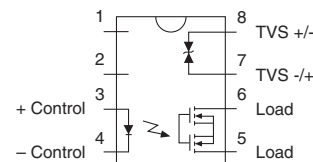

Switching Characteristics of Normally Open Devices

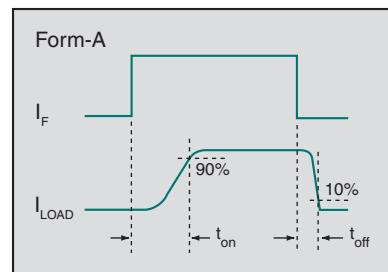

### Absolute Maximum Ratings @ 25°C

Parameter	Ratings	Units
SSR Output Blocking Voltage	350	V <sub>P</sub>
TVS Working Voltage, Maximum (V <sub>RWM</sub> )	40.2	V
Reverse Input Voltage	5	V
Input Control Current	50	mA
Peak (10ms)	1	A
Input Power Dissipation <sup>1</sup>	150	mW
SSR Output Power Dissipation <sup>2</sup>	400	mW
TVS Peak Pulse Power (P <sub>PP</sub> ) (I <sub>PP</sub> =9.3A, 10/1000µs pulse)	600	W
Isolation Voltage, Input to Output	3750	V <sub>rms</sub>
Operating Temperature, Ambient	-40 to +85	°C
Storage Temperature	-40 to +125	°C

<sup>1</sup> Derate linearly 1.33 mW / °C

<sup>2</sup> Derate output power linearly 6.67 mW / °C

Absolute Maximum Ratings are stress ratings. Stresses in excess of these ratings can cause permanent damage to the device. Functional operation of the device at conditions beyond those indicated in the operational sections of this data sheet is not implied.

Typical values are characteristic of the device at +25°C, and are the result of engineering evaluations. They are provided for information purposes only, and are not part of the manufacturing testing requirements.

### Electrical Characteristics: TVS

Parameters	Conditions	Symbol	Min	Typ	Max	Units
<b>Output Characteristics @ 25°C</b>						
Clamping Voltage	I <sub>PP</sub> =9.3A	V <sub>C</sub>	-	-	66.5	V
Reverse Breakdown Voltage	I=1mA	V <sub>BR</sub>	44.4	-	-	V
Reverse Leakage Current	V <sub>RWM</sub> =40.2V	I <sub>L</sub>	-	-	5	µA

### Electrical Characteristics @ 25°C

Parameters	Conditions	Symbol	Min	Typ	Max	Units
<b>Output Characteristics</b>						
Blocking Voltage	I <sub>L</sub> =1µA	V <sub>DRM</sub>	350	-	-	V <sub>P</sub>
Load Current						
Continuous <sup>1</sup>	I <sub>F</sub> =2mA	I <sub>L</sub>	-	-	100	mA <sub>rms</sub> / mA <sub>DC</sub>
Peak	t=10ms	I <sub>LPK</sub>	-	-	±350	mA
On-Resistance <sup>2</sup>	I <sub>L</sub> =100mA	R <sub>ON</sub>	-	25	35	Ω
Off-State Leakage Current	V <sub>L</sub> =350V <sub>P</sub>	I <sub>LEAK</sub>	-	-	1	µA
Switching Speeds						
Turn-On	I <sub>F</sub> =2mA, V <sub>L</sub> =10V	t <sub>on</sub>	-	-	10	ms
Turn-Off	(See Timing Diagram)	t <sub>off</sub>	-	-	10	
Output Capacitance	I <sub>F</sub> =0V, V <sub>L</sub> =50V, f=1MHz	C <sub>OUT</sub>	-	40	-	pF
<b>Input Characteristics</b>						
Input Control Current to Activate <sup>3</sup>	I <sub>L</sub> =100mA	I <sub>F</sub>	-	-	1	mA
Input Voltage Drop	I <sub>F</sub> =5mA	V <sub>F</sub>	0.9	1.36	1.5	V
Reverse Input Current	V <sub>R</sub> =5V	I <sub>R</sub>	-	-	10	µA
<b>Common Characteristics</b>						
Input to Output Capacitance	V <sub>IO</sub> =0V, f=1MHz	C <sub>IO</sub>	-	3	-	pF

<sup>1</sup> Load current derates linearly from 100mA @ 25°C to 70mA @ 85°C

<sup>2</sup> Measurement taken within 1 second of on-time

<sup>3</sup> For applications requiring high temperature operation (greater than 60°C) a minimum LED drive current of 3mA is recommended.

### Timing Diagram

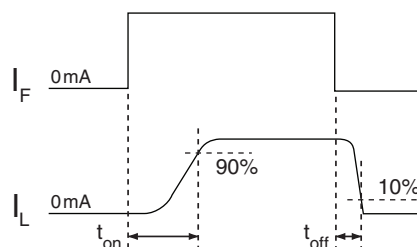

**PERFORMANCE DATA\***

**Typical LED Forward Voltage Drop**  
(N=50,  $I_F=5\text{mA}$ )

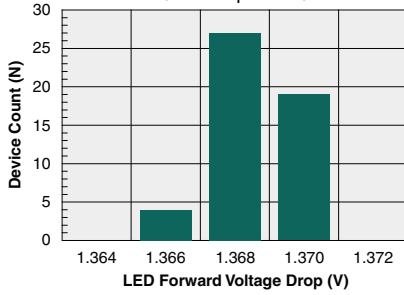

**Typical Turn-On Time**  
(N=50,  $I_F=5\text{mA}$ ,  $I_L=100\text{mA}$ )

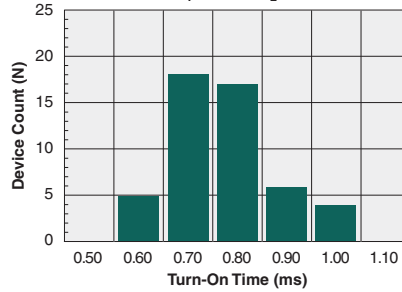

**Typical Turn-Off Time**  
(N=50,  $I_F=5\text{mA}$ ,  $I_L=100\text{mA}$ )

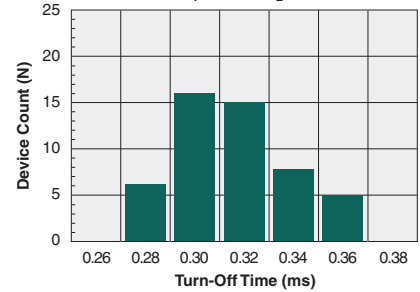

**Typical  $I_F$  for Switch Operation**  
(N=50,  $I_L=100\text{mA}$ )

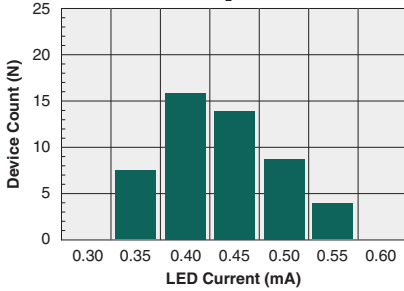

**Typical On-Resistance Distribution**  
(N=50,  $I_L=120\text{mA}$ )

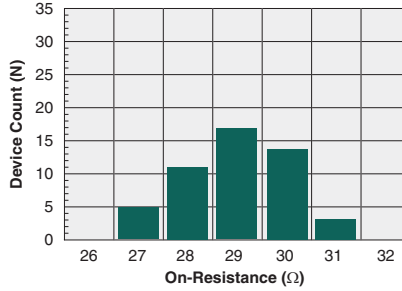

**Typical Blocking Voltage Distribution**  
(N=50)

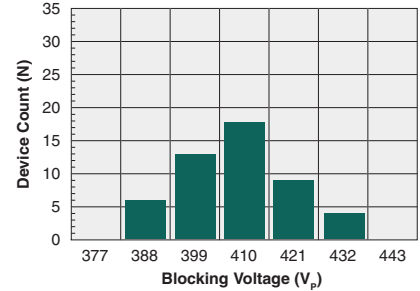

**Typical LED Forward Voltage Drop vs. Ambient Temperature**

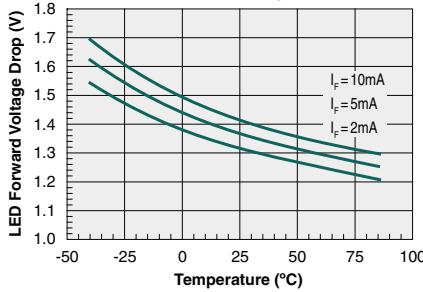

**Turn-On Time vs. LED Forward Current**

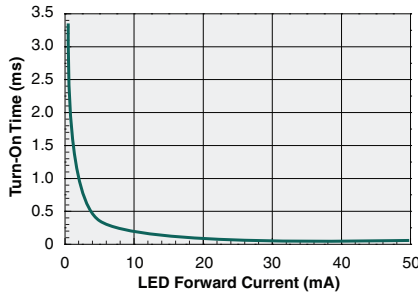

**Typical Turn-Off Time vs. LED Forward Current**

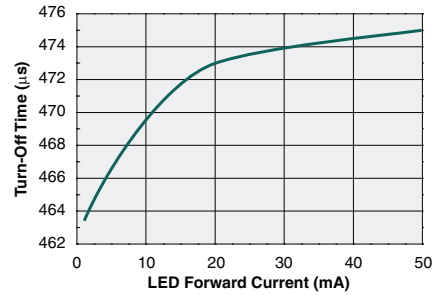

**Typical LED Current to Operate vs. Ambient Temperature**  
( $I_L=70\text{mA}$ )

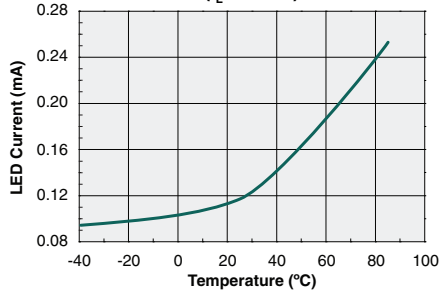

**Typical Turn-On Time vs. Ambient Temperature**  
( $V_L=10\text{V}$ )

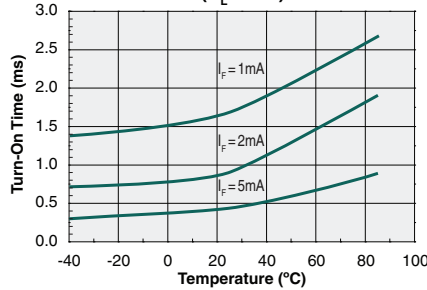

**Typical Turn-Off Time vs. Ambient Temperature**  
( $V_L=10\text{V}$ )

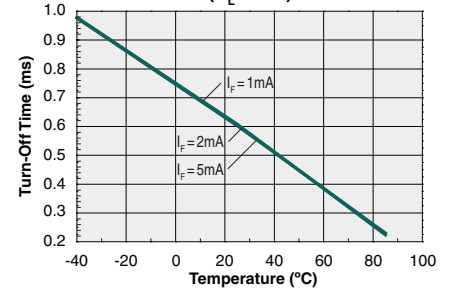

\*Unless otherwise noted, data presented in these graphs is typical of device operation at  $T_A=25^\circ\text{C}$ .

**PERFORMANCE DATA\***

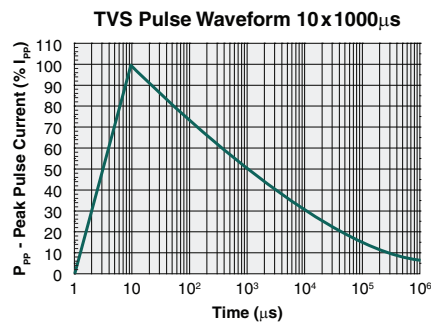
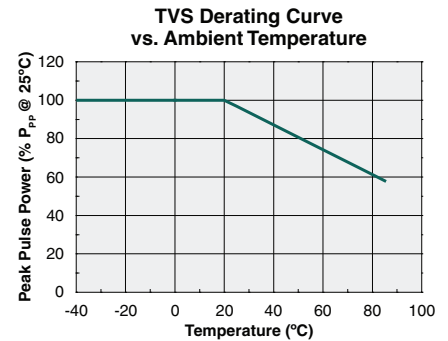
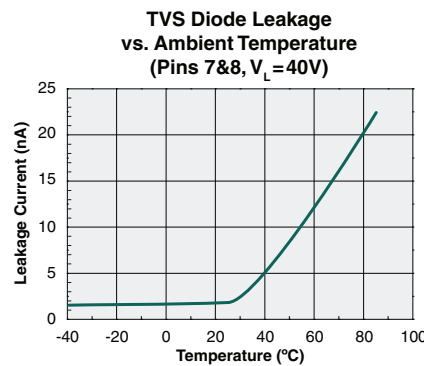
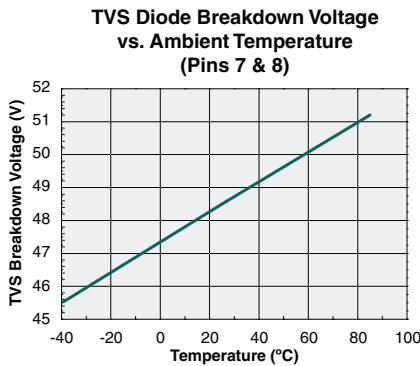
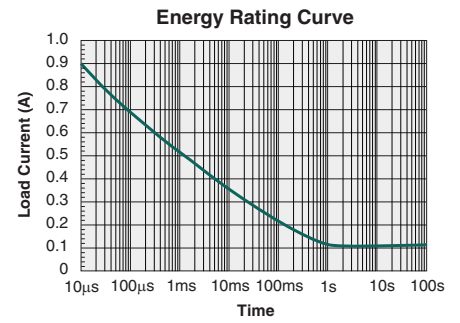
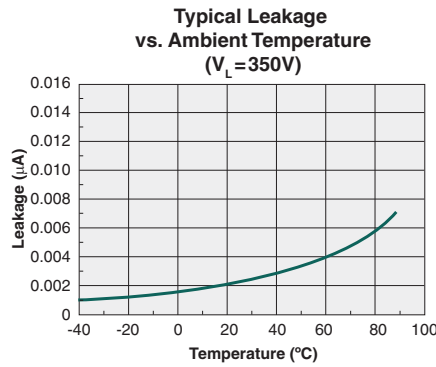
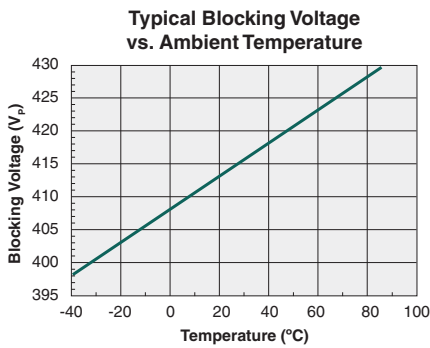
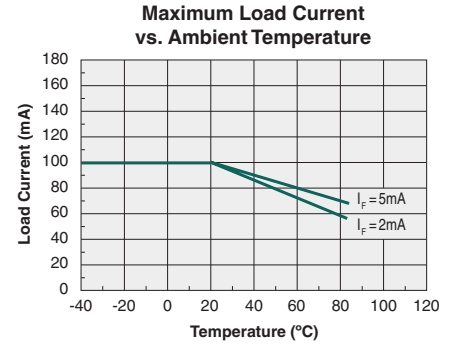
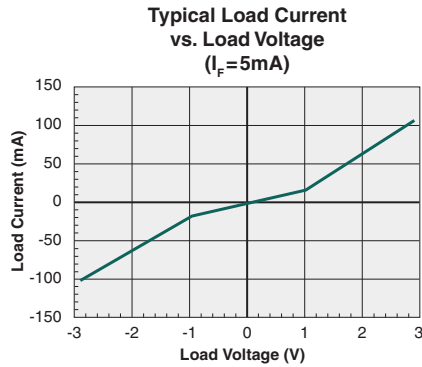
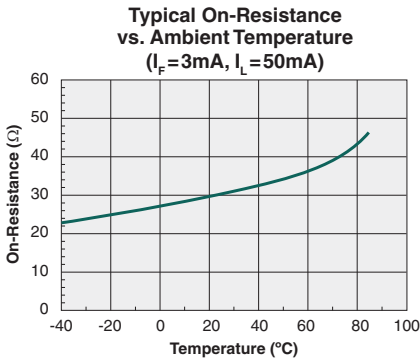

\*Unless otherwise noted, data presented in these graphs is typical of device operation at  $T_A = 25^\circ\text{C}$ .

## Manufacturing Information

### Moisture Sensitivity



All plastic encapsulated semiconductor packages are susceptible to moisture ingress. Littelfuse classifies its plastic encapsulated devices for moisture sensitivity according to the latest version of the joint industry standard, **IPC/JEDEC J-STD-020**, in force at the time of product evaluation. We test all of our products to the maximum conditions set forth in the standard, and guarantee proper operation of our devices when handled according to the limitations and information in that standard as well as to any limitations set forth in the information or standards referenced below.

Failure to adhere to the warnings or limitations as established by the listed specifications could result in reduced product performance, reduction of operable life, and/or reduction of overall reliability.

This product carries a **Moisture Sensitivity Level (MSL)** classification as shown below, and should be handled according to the requirements of the latest version of the joint industry standard **IPC/JEDEC J-STD-033**.

Device	Moisture Sensitivity Level (MSL) Classification
CPC1335P	MSL 3

### ESD Sensitivity



This product is ESD Sensitive, and should be handled according to the industry standard **JESD-625**.

### Soldering Profile

Provided in the table below is the **IPC/JEDEC J-STD-020** Classification Temperature ( $T_c$ ) and the maximum total dwell time ( $t_p$ ) in all reflow processes that the body temperature of these surface mount devices may be ( $T_c - 5$ )°C or greater. The device's body temperature must not exceed the Classification Temperature at any time during reflow soldering processes.

Device	Classification Temperature ( $T_c$ )	Dwell Time ( $t_p$ )	Max Reflow Cycles
CPC1335P	245°C	30 seconds	3

### Board Wash

Littelfuse recommends the use of no-clean flux formulations. Board washing to reduce or remove flux residue following the solder reflow process is acceptable provided proper precautions are taken to prevent damage to the device. These precautions include but are not limited to: using a low pressure wash and providing a follow up bake cycle sufficient to remove any moisture trapped within the device due to the washing process. Due to the variability of the wash parameters used to clean the board, determination of the bake temperature and duration necessary to remove the moisture trapped within the package is the responsibility of the user (assembler). Cleaning or drying methods that employ ultrasonic energy may damage the device and should not be used. Additionally, the device must not be exposed to halide flux or solvents.



### MECHANICAL DIMENSIONS

#### CPC1335P

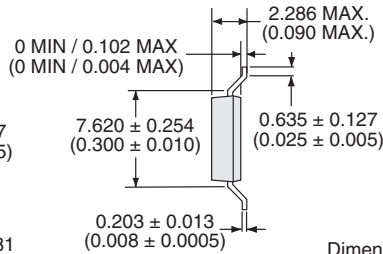
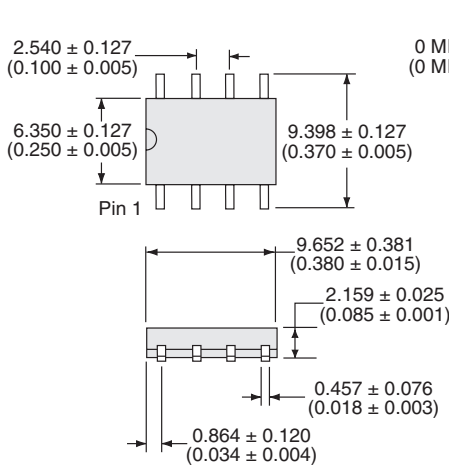

Dimensions  
mm  
(inches)

Notes:

1. Controlling dimension: Inches
2. Coplanarity = 0.004" (0.102 mm) max
3. Leadframe thickness does not include solder plating (1000μinches max)
3. Sum of package height, standoff, and coplanarity shall not exceed 0.090" (2.286 mm)

#### PCB Land Pattern

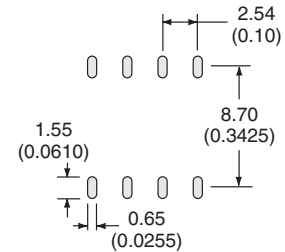

#### CPC1335PTR Tape & Reel

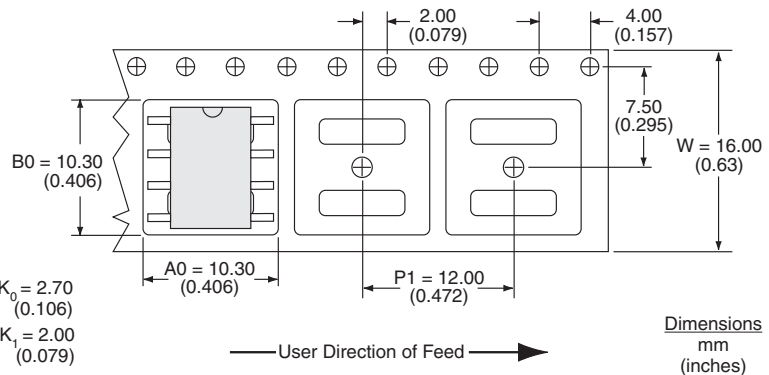
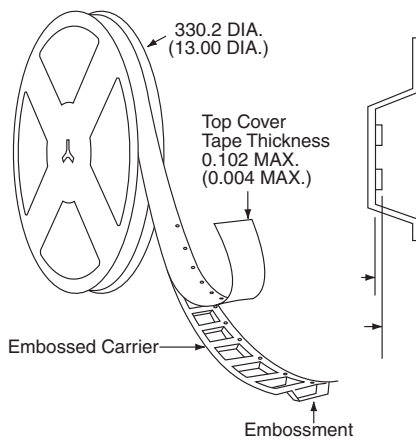

NOTES:

1. All dimensions carry tolerances of EIA Standard 481-2
2. The tape complies with all "Notes" for constant dimensions listed on page 5 of EIA-481-2
3. Controlling dimension: mm

For additional information please visit our website at: <https://www.littelfuse.com>