











**ARC-FLASH RELAYS**  
PRODUCT CAPABILITIES

# Reliable Operation with Built-In Redundancies

When you are entrusting a safety device to protect equipment from catastrophic damage, it is important to know that it will operate as expected. Littelfuse Arc-Flash Relays do this by having built-in redundancies and health monitors, making maintenance and installation tasks faster, more efficient and helping to minimize downtime.

	AF0025	AF0100	AF0500	PGR-8800
 <b>Redundant Internal Trip Path</b> <ul style="list-style-type: none"> <li>Two internal trip paths for added reliability—if the microprocessor trip path fails, the backup analog trip path will seamlessly take over, sending an alarm notification to operators</li> <li>Backup analog trip path initializes very quickly upon power up, ensuring protection is enabled while energizing the system when hazard risk is higher</li> </ul>	<input checked="" type="checkbox"/>	<input checked="" type="checkbox"/>	<input checked="" type="checkbox"/>	<input checked="" type="checkbox"/>
 <b>Health Monitoring</b> <ul style="list-style-type: none"> <li>Continuously monitors connection to trip coil to ensure path is intact</li> <li>LED indication of sensors' "Ready" or "Tripped" status on sensor and relay</li> <li>Sensors are durable enough to withstand a detected arc-flash event</li> </ul>	<input checked="" type="checkbox"/>	<input checked="" type="checkbox"/>	<input checked="" type="checkbox"/>	<input checked="" type="checkbox"/>
 <b>Reliable Light Detection</b> <ul style="list-style-type: none"> <li>Two types of light sensors (point and fiber-optic) for different applications</li> <li>Adjustable light-level and wide-angle detection add flexibility</li> <li>Durable and flexible sensor design eliminates breakage and re-work</li> </ul>		<input checked="" type="checkbox"/>	<input checked="" type="checkbox"/>	<input checked="" type="checkbox"/>
 <b>High-Speed (&lt;1 ms) Trip</b> <ul style="list-style-type: none"> <li>Rapidly initiate the removal of power to reduce the incident energy of the arc flash</li> </ul>			<input checked="" type="checkbox"/>	<input checked="" type="checkbox"/>
 <b>Upstream Tripping</b> <ul style="list-style-type: none"> <li>Ability to trip upstream device if the local breaker fails to clear the fault</li> </ul>			<input checked="" type="checkbox"/>	<input checked="" type="checkbox"/>
 <b>Data Logging</b> <ul style="list-style-type: none"> <li>Quickly assess the factors that led to a trip in order to get back online quickly</li> </ul>			<input checked="" type="checkbox"/>	<input checked="" type="checkbox"/>
 <b>Optional Current Detection for Fault Verification</b> <ul style="list-style-type: none"> <li>Avoid nuisance tripping with current-supervised arc-flash trips</li> <li>Phase Current Transformers for overcurrent detection</li> <li>Two user-defined definite-time overcurrent protection levels and times</li> </ul>				<input checked="" type="checkbox"/>
 <b>Tie Breaker Tripping</b> <ul style="list-style-type: none"> <li>Ability to trip both incoming feeder and tie breaker when arc is detected in one section of a switchboard</li> <li>Affected part of the switchboard is isolated from the non-affected part</li> </ul>			<input checked="" type="checkbox"/>	
 <b>Zone Tripping</b> <ul style="list-style-type: none"> <li>Ability to trip 2 separate zones with 1 relay</li> <li>Sensor zone assignment through simple PC configuration and/or digital inputs and outputs</li> </ul>		<input checked="" type="checkbox"/>	<input checked="" type="checkbox"/>	

# Fast Arc-Flash Detection

## in Less Than 1 ms

Minimize Damage. Circuit breakers or overcurrent protection devices (OCPDs) alone do not provide optimal protection for your personnel and equipment. The Littelfuse Arc-Flash Relays rapidly detect an arc flash and send a trip signal to interrupt power.

### PGR-8800 Arc-Flash Relay

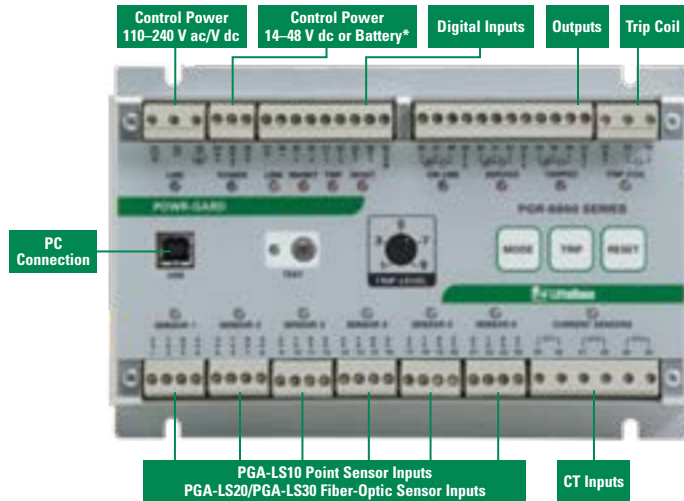

\*Backup battery not included

### AF0500 Arc-Flash Relay

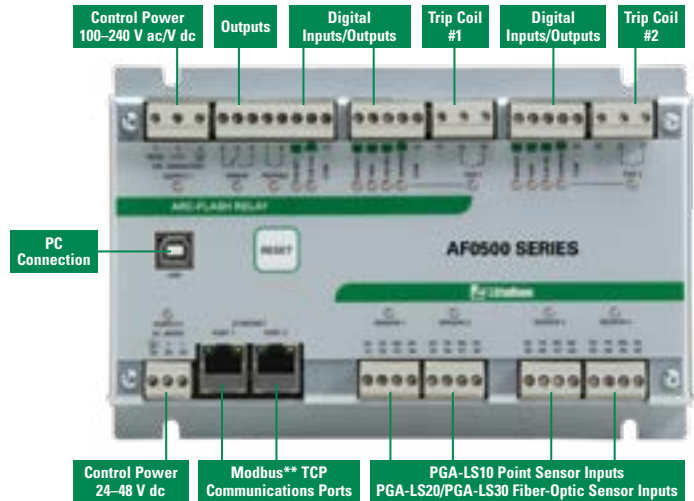

## Simple Plug & Play Installation and Maintenance

The Littelfuse Arc-Flash Relays and sensors are easily retrofitted into existing switchgear or pre-installed in new equipment with little or no configuration. Even elaborate systems only take minutes to configure.

- Improve sustainability and life of electrical equipment
- Lower the PPE Category of the equipment
- Provide protection against equipment damage and potential injury to personnel or incident energy
- Easily installed without changes to existing layout
- Flexible sensor configuration for any application
- No additional software is required

## In the Zone

The AF0500 Arc-Flash Relay provides tie breaker and zone tripping capabilities - one relay trips two separate zones. With unrestricted scalability, multiple AF0500 relays can be connected to cover multiple zones.

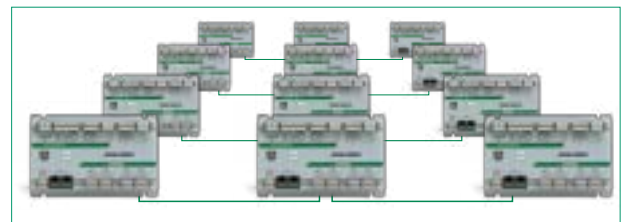

\*\*Modbus is a trademark of its respective owner.

# Reliable Arc-Flash Detection

## for Small Spaces

**AF0100 Arc-Flash Relay**

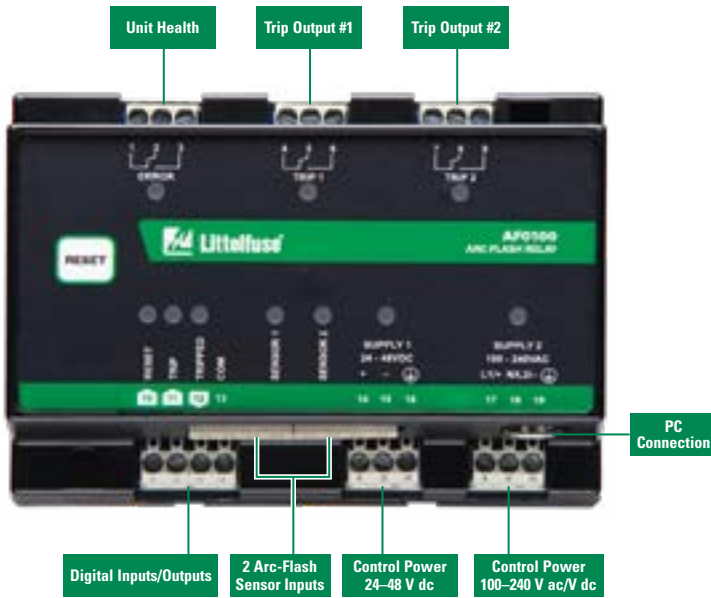

**AF0025 Space Saver**

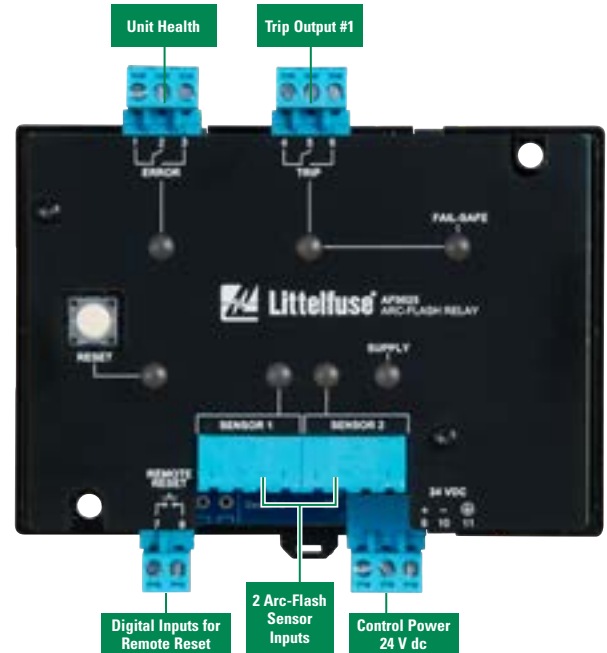

## Small and Adjustable

Smaller incident energy. Smaller footprint. Smaller cost. The AF0100 and AF0025 deliver leading arc-flash technology at a size and price to make improved electrical safety accessible for everyone.

### Width and Height Footprint

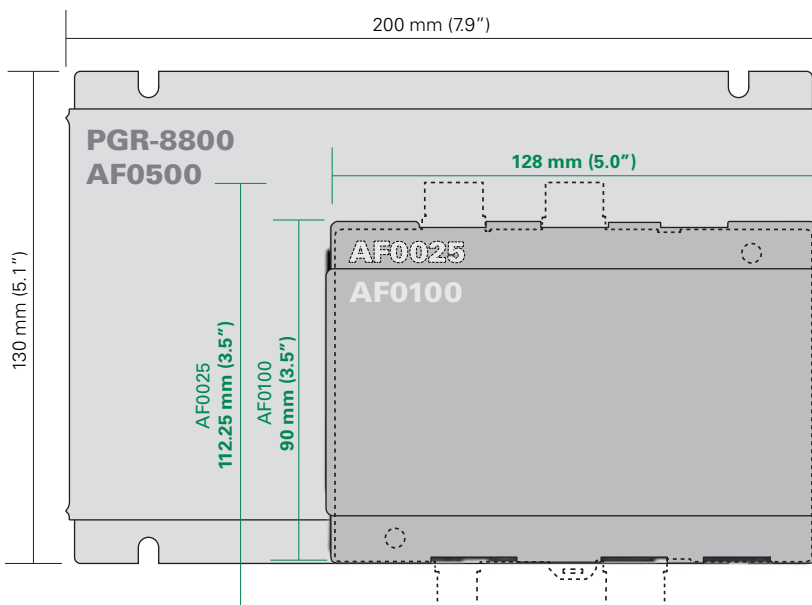

### Depth Footprint

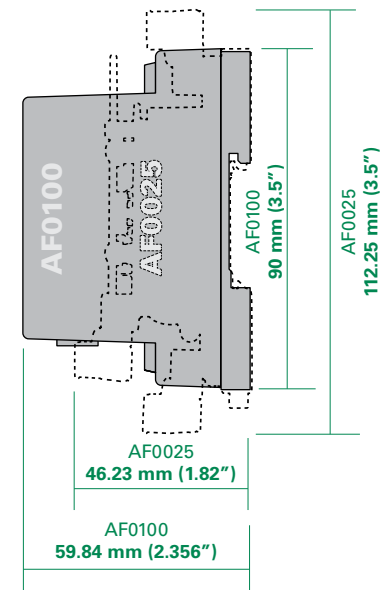

# Robust Sensor Design



## Point Light Sensor

Line-of-sight light sensor detects an arc as small as 3 kA in a 2-meter half-sphere radius.

- Visual LED indication for "Ready" or "Tripped" state to assist with fault location
- Robust sensor design can withstand a detected arc-flash event
- Fixed length of 1 m for the AF0025 relay

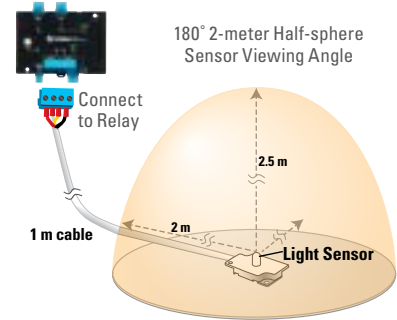

## Point Light Sensor

Line-of-sight light sensor detects an arc as small as 3 kA in a 2-meter half-sphere radius.

- Visual LED indication for "Ready" or "Tripped" state to assist with fault location
- Robust sensor design can withstand a detected arc-flash event
- Sensor can be installed up to 50 m (164 ft) away from relay; electrical cable can be cut and easily re-terminated in the field

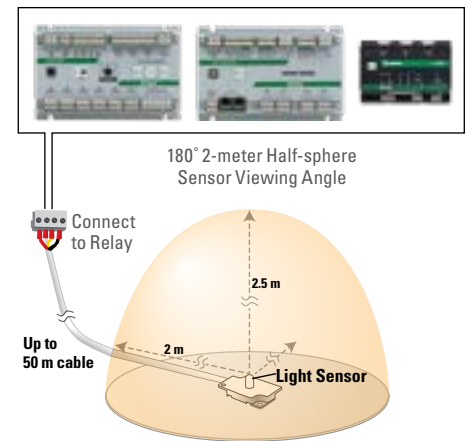

## Fiber-Optic Light Sensor

The 360° light sensor detects light throughout the entire length of the fiber. Ideal to protect bus bars, multiple compartment installations like motor control centers, or areas with many obstructions.

- Visual LED indication for "Ready" or "Tripped" state to assist with fault location
- Durable resin fiber material allows small bending radius (> 5 cm) and greater flexibility without breaking
- Ready to install from the factory, no need to terminate in the field or polish as with glass fiber
- Fiber sensors can be installed in locations up to 50 m (164 ft) away from relay; electrical cable can be cut and easily re-terminated in the field

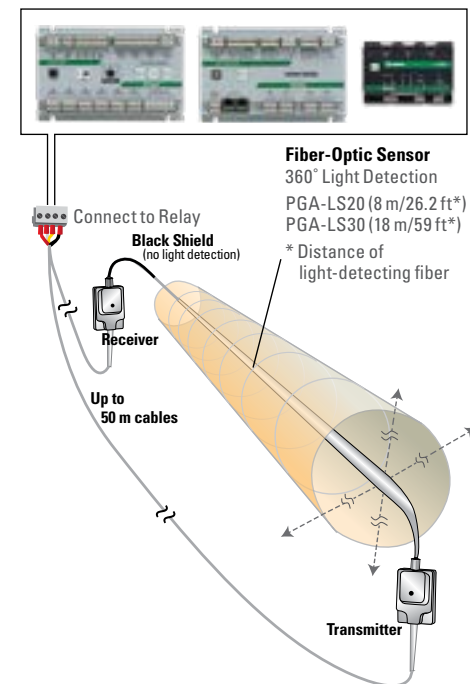



## Technical Specifications



### PGR-8800 Arc-Flash Relay

<b>Relay Part Nos.</b>	PGR-8800-00 PGR-8800-00-CC (conformal coating)
<b>Sensor Inputs</b>	6 light sensor inputs for PGA-LS10, PGA-LS20 and PGA-LS30 sensors
<b>Sensor Part Nos.</b>	PGA-LS10 (Point) PGA-LS20 (Fiber-Optic) PGA-LS30 (Fiber-Optic)
<b>IEEE Device No.</b>	Overcurrent (50), Arc Flash (AFD)
<b>Input Voltage</b>	100–240 V ac, 110–250 V dc, or 14–48 V dc
<b>Dimensions</b>	<b>H</b> 130 mm (5.2") <b>W</b> 200 mm (7.9") <b>D</b> 54 mm (2.2")
<b>Optical Trip Settings</b>	9–25 klux
<b>Trip Coil Output</b>	<1 ms; IGBT switch <u>Current Rating:</u> <u>Voltage Rating:</u> 750 mA cont. 24–300 V ac 20 A for 2 s 24–300 V dc 10 A for 5 s
<b>Relay Outputs</b>	Programmable <u>Form C Output Contact:</u> 5 A at 250 V ac/30 V dc <u>Status Output Contact:</u> 3 A at 50 V ac/50 V dc
<b>Communications</b>	RS-485, Modbus* RTU
<b>System Expansion</b>	Link up to 4 units
<b>Sensors</b>	Up to 24 (6 per unit)
<b>Battery</b>	24 V lead-acid gel cell (not included)
<b>Approvals</b>	CE, UL Listed (UL508), RCM, CSA, DNV
<b>Warranty</b>	5 years
<b>Mounting</b>	DIN, surface mount

### AF0500 Arc-Flash Relay

<b>Relay Part Nos.</b>	AF0500-00 AF0500-00-CC (conformal coating)
<b>Sensor Inputs</b>	4 light sensor inputs for PGA-LS10, PGA-LS20 and PGA-LS30 sensors
<b>Sensor Part Nos.</b>	PGA-LS10 (Point) PGA-LS20 (Fiber-Optic) PGA-LS30 (Fiber-Optic)
<b>IEEE Device No.</b>	Arc Flash (AFD)
<b>Input Voltage</b>	100–240 V ac, 110–250 V dc, or 24–48 V dc
<b>Dimensions</b>	<b>H</b> 130 mm (5.1") <b>W</b> 200 mm (7.9") <b>D</b> 54 mm (2.1")
<b>Optical Trip Settings</b>	10–30 klux
<b>Trip Coil Outputs</b>	<1 ms; IGBT switch <u>Current Rating:</u> <u>Voltage Rating:</u> 750 mA cont. 24–300 V ac 20 A for 2 s 24–300 V dc 10 A for 5 s
<b>Communications</b>	Ethernet, 2 ports with internal Ethernet switch, Modbus* TCP
<b>System Expansion</b>	Unlimited
<b>Sensors</b>	4 per unit
<b>Approvals</b>	CE, UL (UL508), RCM
<b>Warranty</b>	5 years
<b>Mounting</b>	Surface, DIN (with optional D0050 adapter clips)

### AF0100 Arc-Flash Relay

<b>Relay Part Nos.</b>	AF0100-00: Universal supply AF0100-00-CC: Universal supply (conformal coating) AF0100-10: 24–48 V dc supply AF0100-10-CC: 24–48 V dc supply (conformal coating)
<b>Sensor Inputs</b>	2 light sensor inputs for PGA-LS10, PGA-LS20 and PGA-LS30 sensors
<b>Sensor Part Nos.</b>	PGA-LS10 (Point) PGA-LS20 (Fiber-Optic) PGA-LS30 (Fiber-Optic)
<b>IEEE Device No.</b>	Arc Flash (AFD)
<b>Input Voltage</b>	100–240 V ac/V dc, 24–48 V dc
<b>AF0100-00</b>	24–48 V dc
<b>AF0100-10</b>	24–48 V dc
<b>Dimensions</b>	<b>H</b> 90 mm (3.5") <b>W</b> 128 mm (5.0") <b>D</b> 60 mm (2.4")
<b>Optical Trip Settings</b>	10–25 klux
<b>Trip Coil Outputs</b>	<5 ms (typical); Relay output <u>Current Rating:</u> <u>Voltage Rating:</u> 6 A cont. 250 V ac/V dc 30 A for 0.2 s 250 V ac/V dc
<b>Communications</b>	None
<b>System Expansion</b>	Unlimited
<b>Sensors</b>	2 per unit
<b>Approvals</b>	CE, UL (UL508), RCM, FCC
<b>Warranty</b>	2 years
<b>Mounting</b>	Surface, DIN rail

### PGA-1100 Diode Logic Unit

<b>Type</b>	Diode logic unit
<b>Diodes</b>	1000 V reverse voltage, 3 A continuous, 25 A for 1 second
<b>Certification</b>	CE
<b>Dimensions</b>	<b>H</b> 70 mm (2.76") <b>W</b> 20 mm (5.90") <b>D</b> 80 mm (3.15")

\*Modbus is a trademark of its respective owner.

## AF0025 Arc-Flash Relay

<b>Relay Part Nos.</b>	AF0025-00
<b>Sensor Inputs</b>	2 light sensor inputs for PGA-LS10-01B
<b>Sensor Part Nos.</b>	PGA-LS10-01B (Point)
<b>Input Voltage</b>	24 V dc
<b>Dimensions</b>	<b>H</b> 112.25 mm (4.42"); <b>W</b> 127.50 mm (5.01"); <b>D</b> 46.23 mm (1.82")
<b>Trip and Error Output Contacts</b>	Form C, 250 V ac/30 V dc, 6 A resistive
<b>Onboard and Remote Reset</b>	Allows for flexible reset options, mounted internal or external to the cabinet
<b>Communications</b>	None
<b>Sensors</b>	2 per unit
<b>Approvals</b>	CE, FCC
<b>Warranty</b>	2 years
<b>Mounting</b>	Surface, or DIN rail

## PGA-LS10 Point Sensor

<b>Type</b>	Point light sensor
<b>Detection Radius</b>	180° Line-of-sight light sensor
<b>Trip Status LED</b>	Displays "tripped" state on each sensor
<b>Health Status LED</b>	Displays "ready" state on each sensor
<b>Electrical Cable</b>	<b>PGA-LS10:</b> 10 m (32.8 ft) included, expandable to 50 m (164 ft) <b>PGA-LS10-01B:</b> Fixed length of 1 m for the AF0025 relay

## PGA-LS20/LS30 Fiber-Optic Sensors

<b>Type</b>	Fiber-optic light sensor
<b>Detection Radius</b>	360° Line-of-sight light sensor
<b>Trip Status LED</b>	Displays "tripped" state on each sensor
<b>Health Status LED</b>	Displays "ready" state on each sensor
<b>Sensor Length</b>	<b>PGA-LS20:</b> 8 m (26.2 ft) active; 10 m (32.8 ft) total <b>PGA-LS30:</b> 18 m (59 ft) active; 20 m (66 ft) total
<b>Electrical Cable</b>	10 m (32.8 ft) included, expandable to 50 m (164 ft)

## Sensor Placement Recommendations

Generally, it is recommended to mount 1 or 2 sensors per cubicle to cover all horizontal and vertical bus bars, breaker compartments, drawers, and anywhere that there is potential for an arc fault. Threading a fiber-optic sensor through the cabinets and in areas where point-sensor coverage is uncertain results in complete coverage and an added level of protection. Even if policy is to only work on de-energized systems, all maintenance areas should be monitored for arc flash to prevent potential damage and additional cost. For more information, download the Installation Guide PF711 from [Littelfuse.com/ArcFlash](http://Littelfuse.com/ArcFlash).

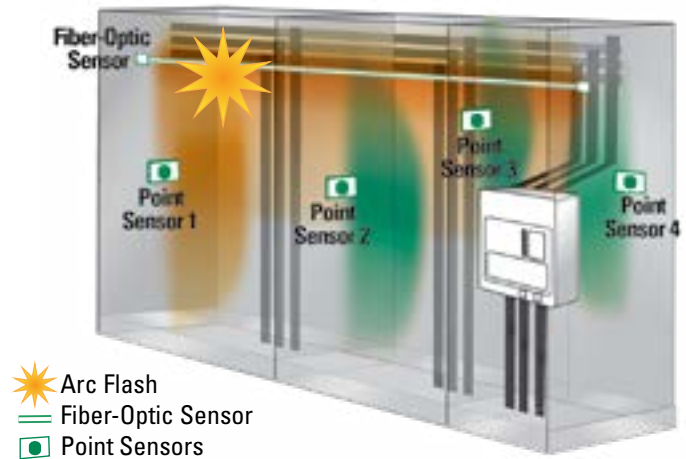

Scenario with point sensor placement on the wall of each compartment. Arc detection area for each sensor is shown in green shade. In this case, both Point Sensor 1 and the Fiber-Optic Sensor detected the flash as it was within their viewing area (shown in orange).

## Build an Arc-Flash Protection System

Connect the AF0100 and AF0500 together to design a right-sized protection system. Use the innovative digital input and output terminals to add sensors or zones. Build your custom protection without complex programming or configuration.

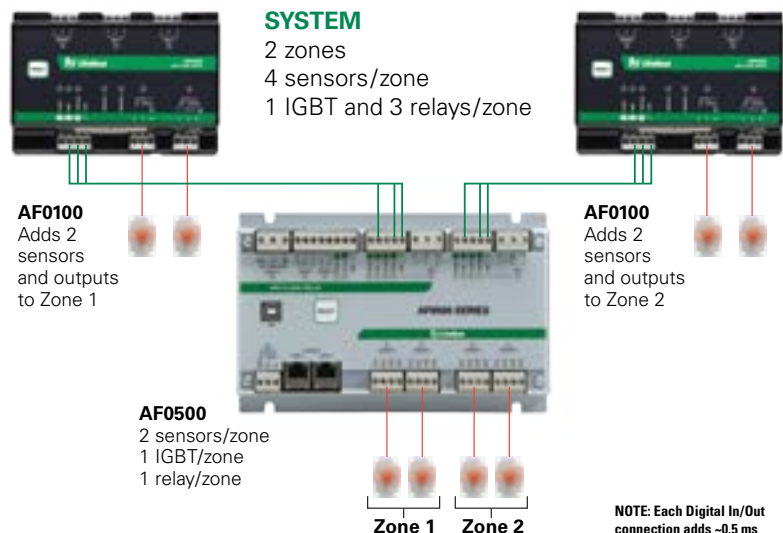

# Case Studies



## General Manufacturing

Tim Deschamp from Evans Enterprises, Tulsa, Oklahoma, was working with a customer to help them resolve and reduce a critical issue with an electrical hazard in their furnace control room. An earlier arc-flash analysis had determined that one 480-volt cabinet, which was fed from a 3500 kVA transformer, exceeded an arc-flash Hazard Risk Category 4 (HRC). Deschamp needed to find a way to lower the HRC so he could work on the cabinet. He installed the PGR-8800 Arc-Flash Relay in less than three hours in the controls section of the cabinet, with two light sensors mounted in each of the three power compartments. The trip output of the relay was connected to the shunt trip input of the main breaker.

Only one week after the relay was installed, the plant experienced an arc-flash incident. "Had this relay not been there, they were looking at between \$800,000 and \$1 million of cost, considering downtime and equipment replacement," Deschamp said.



## Food & Beverage Processing

Littelfuse Arc-Flash Relays are the main ingredient in safety and reduced downtime for a major beer manufacturer. The brewer saw a need to reduce high incident energy for a 480 V DS style switchgear application to a PPE category below 8 cal/cm<sup>2</sup>. They were considering ARMS (Arc Flash Maintenance System Breakers) but chose the Littelfuse AF0500 arc-flash relay instead. The AF0500 proved to be more cost effective than installing ARMS breakers throughout the facility. The AF0500 was installed, and the substation was back online in 4.5 hours. Cheers!



## Healthcare

A top ranked Chinese hospital with over 4,300 beds installed a new 10 kV switchgear and needed arc-flash hazard mitigation for this critical power continuity. The application required protection for the busbar region where the relay could trip the incoming breaker and busbar tie breaker plus protection in the switchgear and cable section where the relay could trip the individual panel. The added protection of the arc-flash relay would prevent equipment damage, personnel injury, and improve reliability of the power supply. They chose the PGR-8800 arc-flash relay because it has four outputs to meet their trip scheme, proven no nuisance tripping, quick response time, safety approvals, and easy plug-and-play installation.

The Littelfuse Arc-Flash Relays use a 125- $\mu$ s light-sampling scheme in combination with an ultra-fast IGBT output to be able to detect a developing arc flash and send a trip signal to a circuit breaker in milliseconds.

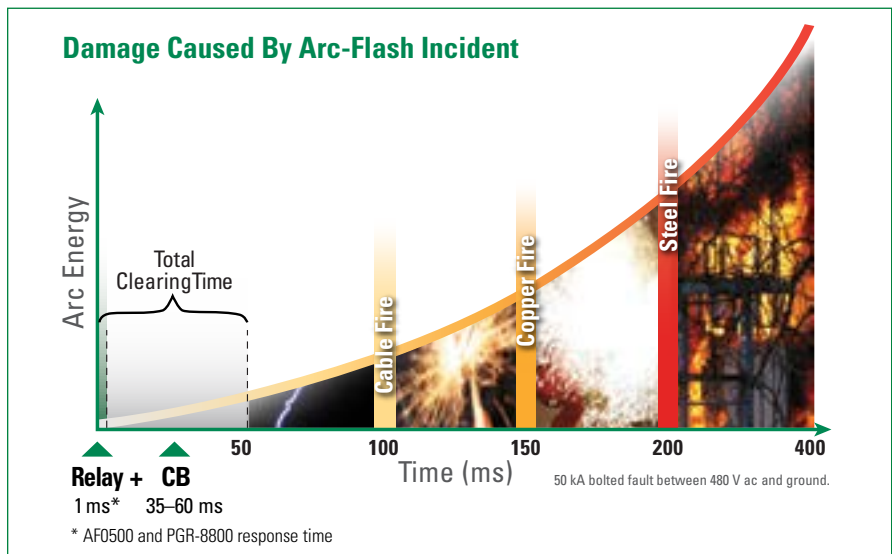



# FAQ

## *Do arc-flash relays lower the Personal Protective Equipment (PPE) required?*

In order to lower the amount of PPE required, the incident energy must be reduced. There are two ways to lower the incident energy of an arc-flash event, reducing the fault current or the clearing time and reducing the available energy. Reducing the available energy can be achieved by using current-limiting fuses and, for single-phase faults, resistance grounding. Reducing the clearing time typically is not possible when using overcurrent protection due to system coordination requirements. Current-based protection must have sufficient delay to prevent unnecessary tripping on momentary overload or current spikes, thus losing valuable reaction time. Arc Flash relays resolve this issue by relying primarily on light, which allows for the quickest reaction time in the industry. The PGR-8800 and AF0500 relays can detect an arcing condition and send a trip signal to the circuit breaker within 1 ms. The AF0500 reaction time is between 3-8 ms depending on configuration. This detection time is much faster than standard protection and circuit breakers, which means using an Arc Flash relay in combination with a circuit breaker (PGR-8800 only) will lower the incident energy. This results in an increase in worker safety, less fault damage, and improved uptime. While the arc-flash energy has decreased, determining if the reduction will result in a decreased PPE category will ultimately depend on the electrical system.

## *What are typical arc-flash protection applications?*

Although an arc flash is improbable on systems operating at 208 V or less, systems with higher voltages have sufficient capacity to cause an arc flash and should use proper protection. Arc-flash protection is especially important in the following applications:

**Solidly grounded electrical distribution systems:** It is estimated that over 95 % of all electrical faults are, or begin as, a ground fault. Ground-fault current on a solidly grounded system is only limited by the resistance of the fault and system impedance, and has the potential to cause an arc flash.

**Alarm-only systems:** When ground faults are allowed to persist on a system, particularly in an ungrounded system, the faults can cause rapid deterioration of electrical safety and escalation into an arc flash.

**High-Current Systems:** The 2017 US NEC, section 240.87 includes “active arc-flash mitigation system” in a short list of options that shall be used to reduce clearing time “Where the highest continuous current trip setting for which the actual overcurrent device installed in a circuit breaker is rated or can be adjust is 1200 A or higher.”

**Air-cooled transformers:** On air-cooled equipment, the winding insulation, terminals, and ground points are exposed to the environment. Pollution, dust, and other contaminants can cause premature insulation failure and can lower the resistance of the air gap between energized conductors, and between energized conductors and ground. Insulation failure and lower air-gap resistance increase the probability of an arc flash.

**Generators:** Incident energy levels are typically very high on generators, and portable generators are often in enclosed trailers which make maintenance difficult and dangerous.

**Rack-out breakers:** As a circuit breaker is racked out, there is a potential for an arc flash to develop when the electrical contacts are disconnected while energized.

**Devices with high inrush currents:** Transformers, capacitor-banks, surge arrestors, large motors, and other reactive loads will cause a high-inrush current when energized. To allow these systems to operate properly, instantaneous-current settings on circuit breakers will either be set very high or not used, allowing an arc-flash to remain on the system for longer, or not be detected at all.

**Low-voltage equipment:** Higher fault currents at lower voltage and a mentality that lower voltages are safer than high voltages mean that many arc-flash incidents actually occur on low-voltage equipment.

**Medium and high-voltage equipment:** Medium-voltage equipment (4160 V and higher) often uses air insulation.

**Moveable and mobile electrical equipment:** Mobile electrical equipment is subject to physical damage while in motion and has a higher potential for an arc flash. The designs are often more compact, reducing air gap insulation levels.

**Areas where work or maintenance is regularly performed on energized equipment:** While maintenance personnel are required to wear proper PPE when working on or around energized equipment, an arc-flash relay can be used to lower the levels of hazard that personnel are exposed to.

**Older facilities:** Where often, room is not available for any other means of Arc-Flash Hazard mitigation.

# Application Examples

## PGR-8800

### Switchgear Protection

Monitor each cabinet with a PGA-LS10 point sensor, providing arc-flash protection and fault location indication. The entire length of the back bus bar is monitored by a PGA-LS20 or PGA-LS30 fiber-optic sensor. The PGR-8800 uses current transformers to monitor the current, and trips the local “feeder” circuit breaker only when high amounts of light and current are present. The relay is also configured to only trip the upstream “main” breaker if the local circuit breaker fails to open.

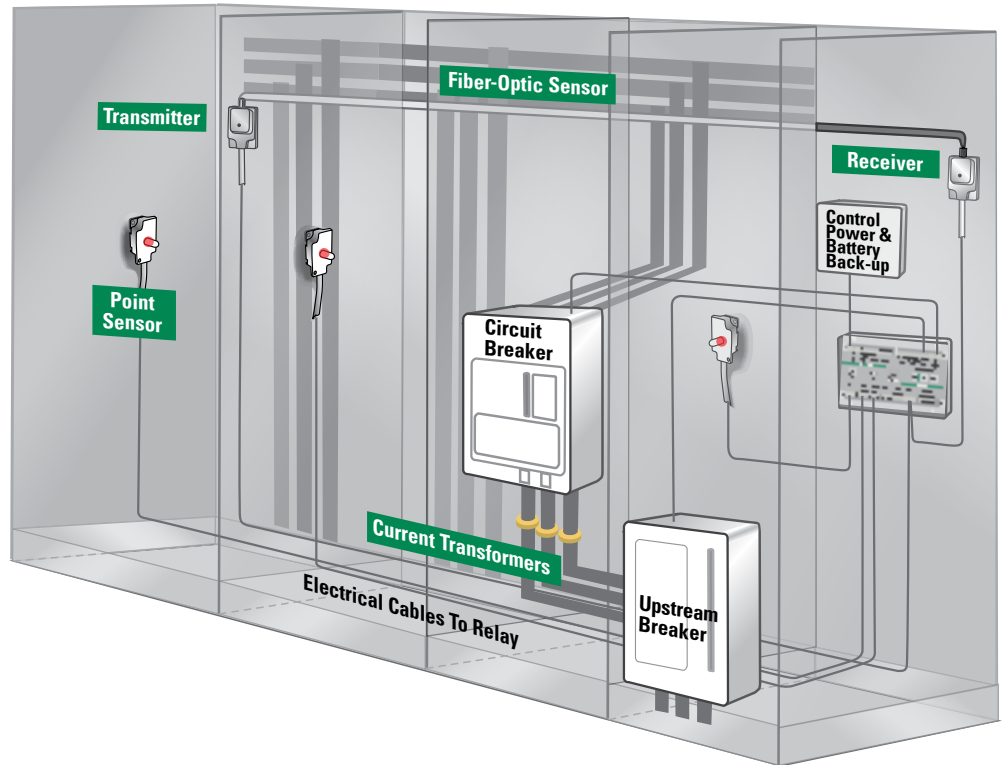

## AF0500

### Main-Tie-Main Protection

In a main-tie-main application, arc-flash energy can come from either main. Protection zones on the AF0500 remove power from the faulted section of the bus by tripping that main and the tie breaker (coupler). Relay A can directly trip both its Main and the tie breaker. Relay B trips its Main and uses a high-speed digital output to make Relay A open the Tie Breaker.

In the event of an arc flash in the tie breaker cabinet, both mains must be tripped. Here, Relay A will trip its Main and use a digital output to make Relay B trip Main Breaker B.

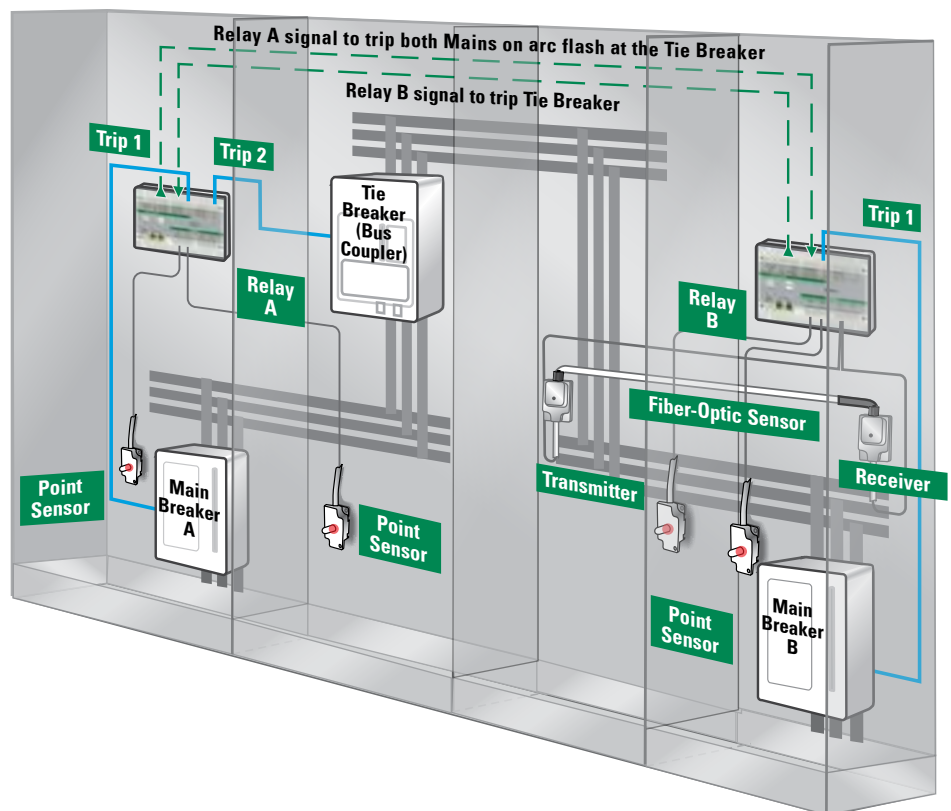

## AF0100

### Generator Protection

Generators are often the last line of defense in powering and protecting critical applications. The generator breaker is the last line of defense protecting the generator itself: there is no protection at all between the line side of the breaker and the generator.

The AF0100 includes two Form-C Trip outputs that quickly respond to an arc flash, turning off the generator using the AVR or other control circuits and disconnecting from the utility or parallel generators by tripping the generator breaker. The AF0100 can be supplied directly off a battery bank and withstand the challenging environment, vibration, and space requirements of a generator application.

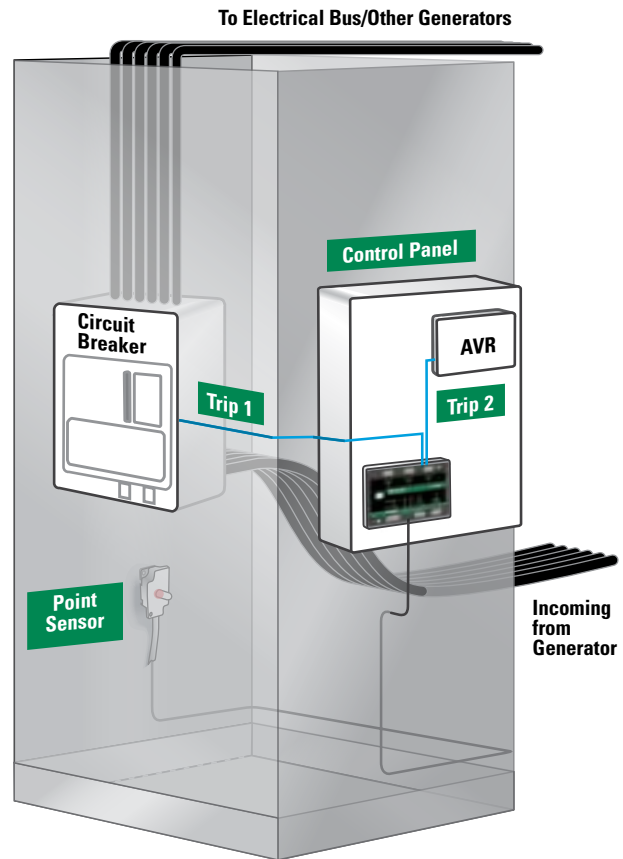

## AF0025

### Space Saving Protection

The compact design of the AF0025 makes it ideal for space saving situations where room on the back of the panel comes at a premium. The AF0025 is small enough to be installed on the side-wall of most control panels, and the DIN rail mounting capability makes for an easy installation. One or two sensors, can be plugged in to the relay, for cost-effective arc flash mitigation in any control panel, or combiner box.



# LOCAL RESOURCES FOR A **GLOBAL** MARKET

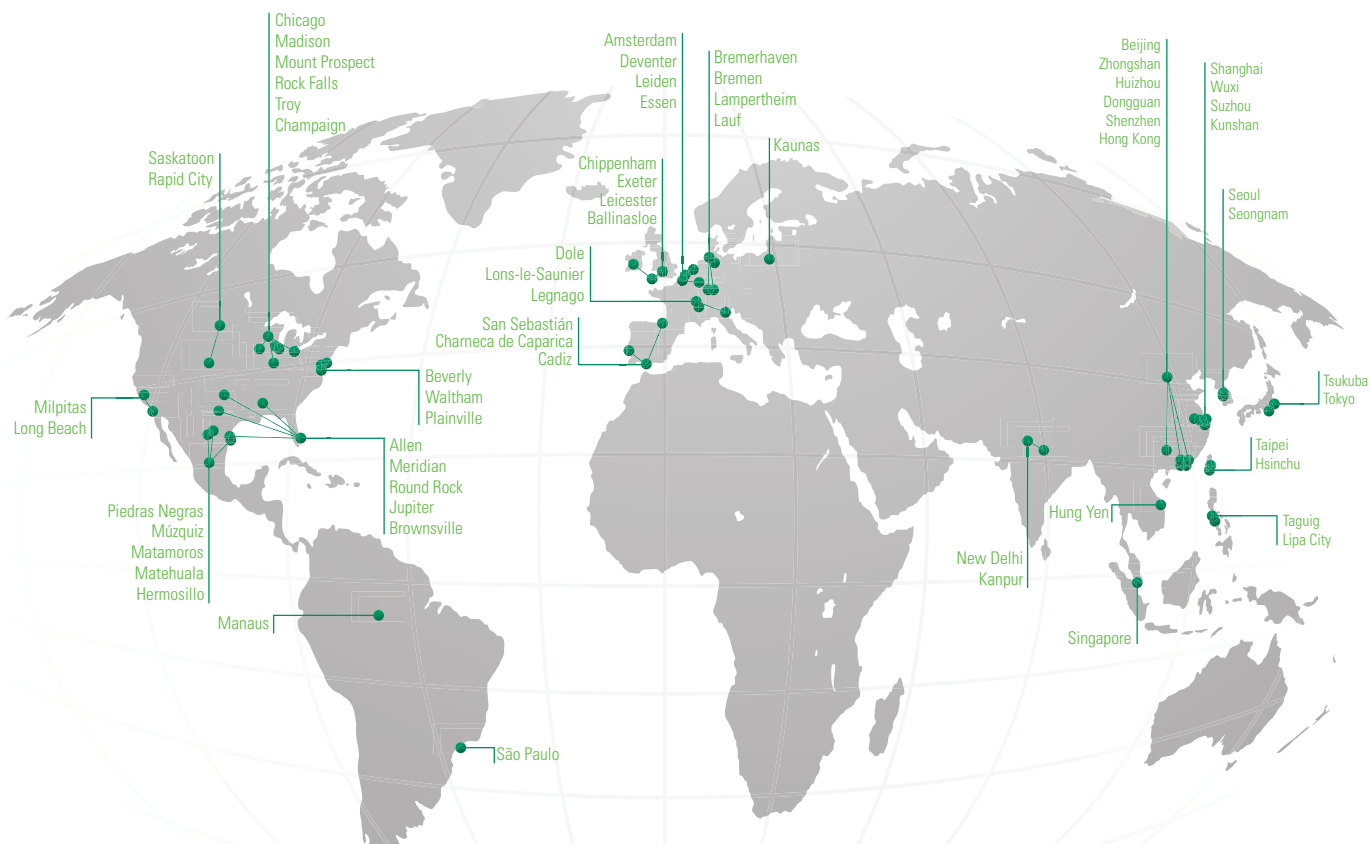

[Littelfuse.com/ArcFlash](https://www.littelfuse.com/ArcFlash)

For a comprehensive library of resources including datasheets, product manuals, white papers, application guides, demos, online design tools, catalogs, and more, visit [Littelfuse.com/TechnicalResources](https://www.littelfuse.com/TechnicalResources)

## North America

**Littelfuse World Headquarters**  
8755 West Higgins Road, Suite 500  
Chicago, IL 60631, USA

**Littelfuse SymCom**  
1241 Concourse Drive  
Rapid City, SD 57703, USA

**Littelfuse Startco**  
140 – 15 Innovation Boulevard  
(The Galleria Building)  
Saskatoon, SK S7N 2X8, Canada  
Tel: +1-306-373-5505

**Littelfuse Hartland Controls**  
807 Antec Road  
Rock Falls, IL 61071, USA  
Tel: +1-815-626-5170

## Fuse and Relay

**Technical Support:**  
Tel: +1-800-TEC-FUSE  
Tel: +1-800-832-3873  
Fuses: [techline@littelfuse.com](mailto:techline@littelfuse.com)  
Relays: [relays@littelfuse.com](mailto:relays@littelfuse.com)

**Customer Service:**  
Tel: +1-800-227-0029  
E-mail: [PG\\_CSG@littelfuse.com](mailto:PG_CSG@littelfuse.com)

## Asia

**Littelfuse**  
Unit 1604B Desay Building,  
Gaoxin Nanyi Ave.  
Hi-Tech Industrial Park  
Nashan District  
Shenzhen, 518057, China  
+86 755 8207 0760

## Europe

**Littelfuse**  
Julius-Bamberger-Str. 8a  
Bremen, D-28279, Germany  
+49 421 82 87 3 147

**Western Automation  
now part of Littelfuse**  
2 Atrius Place, Poolboy,  
Ballinalsee, Co. Galway,  
H53 TD 78, Ireland  
Tel: +353 (0) 90 9643359



Littelfuse products are certified to many standards around the world. To check certifications on specific components, please refer to the specific product datasheet on [Littelfuse.com](https://www.littelfuse.com).

**Disclaimer Notice** – Information furnished is believed to be accurate and reliable. However, users should independently evaluate the suitability of and test each product selected for their own applications. Littelfuse products are not designed for, and may not be used in, all applications. Read complete Disclaimer Notice at [www.littelfuse.com/product-disclaimer](https://www.littelfuse.com/product-disclaimer).