

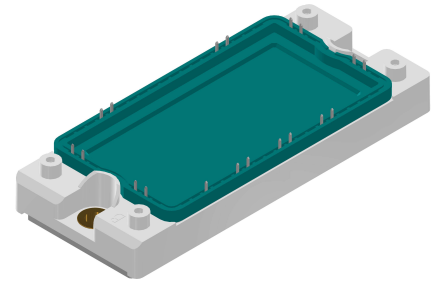
Standard Rectifier Module

| 3~ Rectifier | Brake Chopper |
|----------------------------|-------------------------------|
| $V_{RRM} = 1600 \text{ V}$ | $V_{CES} = 1200 \text{ V}$ |
| $I_{DAV} = 150 \text{ A}$ | $I_{C25} = 180 \text{ A}$ |
| $I_{FSM} = 1100 \text{ A}$ | $V_{CE(sat)} = 1.7 \text{ V}$ |


3~ Rectifier Bridge + Brake Unit + NTC

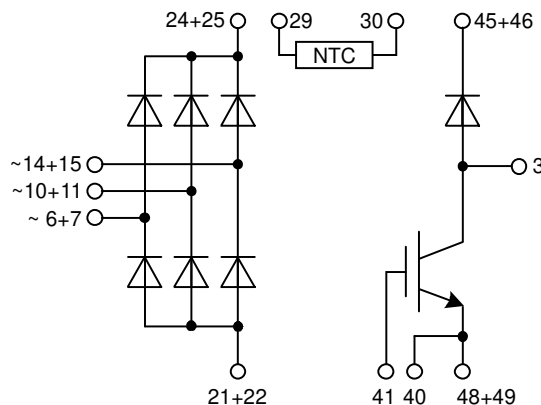
Part number

VUB145-16NOXT



Backside: isolated

 E72873



Features / Advantages:

- Package with DCB ceramic
- Improved temperature and power cycling
- Planar passivated chips
- Very low forward voltage drop
- Very low leakage current
- NTC
- X2PT - 2nd generation Xtreme light Punch Through
- Rugged X2PT design results in:
 - short circuit rated for 10 μsec .
 - very low gate charge
 - low EMI
 - square RBSOA @ 2x I_c
- Thin wafer technology combined with X2PT design results in a competitive low $V_{CE(sat)}$ and low thermal resistance

Applications:

- 3~ Rectifier with brake unit for drive inverters

Package: E2-Pack

- Isolation Voltage: 3600 V~
- Industry standard outline
- RoHS compliant
- Soldering pins for PCB mounting
- Height: 17 mm
- Base plate: Copper internally DCB isolated
- Advanced power cycling
- Phase Change Material available

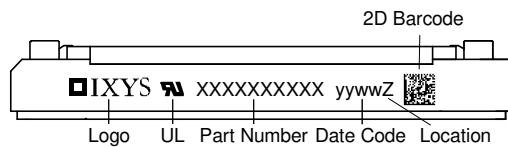
Disclaimer Notice

Information furnished is believed to be accurate and reliable. However, users should independently evaluate the suitability of and test each product selected for their own applications. Littelfuse products are not designed for, and may not be used in, all applications. Read complete Disclaimer Notice at www.littelfuse.com/disclaimer-electronics.

| Rectifier | | | | Ratings | | | |
|------------|--|-----------------------------------|-------------|------------------------------|------|------|-------------------|
| Symbol | Definition | Conditions | | min. | typ. | max. | Unit |
| V_{RSM} | max. non-repetitive reverse blocking voltage | | | | | 1700 | V |
| V_{RRM} | max. repetitive reverse blocking voltage | | | | | 1600 | V |
| I_R | reverse current | $V_R = 1600$ V | | $T_{VJ} = 25^\circ\text{C}$ | | 100 | μA |
| | | $V_R = 1600$ V | | $T_{VJ} = 150^\circ\text{C}$ | | 2 | mA |
| V_F | forward voltage drop | $I_F = 50$ A | | $T_{VJ} = 25^\circ\text{C}$ | | 1.20 | V |
| | | $I_F = 150$ A | | | | 1.68 | V |
| | | $I_F = 50$ A | | $T_{VJ} = 125^\circ\text{C}$ | | 1.13 | V |
| | | $I_F = 150$ A | | | | 1.74 | V |
| I_{DAV} | bridge output current | $T_C = 105^\circ\text{C}$ | rectangular | $T_{VJ} = 150^\circ\text{C}$ | | 150 | A |
| V_{FO} | threshold voltage | } for power loss calculation only | | $T_{VJ} = 150^\circ\text{C}$ | | 0.87 | V |
| r_F | slope resistance | | | | | 5.9 | m Ω |
| R_{thJC} | thermal resistance junction to case | | | | | 0.5 | K/W |
| R_{thCH} | thermal resistance case to heatsink | | | | 0.1 | | K/W |
| P_{tot} | total power dissipation | | | $T_C = 25^\circ\text{C}$ | | 250 | W |
| I_{FSM} | max. forward surge current | $t = 10$ ms; (50 Hz), sine | | $T_{VJ} = 45^\circ\text{C}$ | | 1.10 | kA |
| | | $t = 8,3$ ms; (60 Hz), sine | | $V_R = 0$ V | | 1.19 | kA |
| | | $t = 10$ ms; (50 Hz), sine | | $T_{VJ} = 150^\circ\text{C}$ | | 935 | A |
| | | $t = 8,3$ ms; (60 Hz), sine | | $V_R = 0$ V | | 1.01 | kA |
| I^2t | value for fusing | $t = 10$ ms; (50 Hz), sine | | $T_{VJ} = 45^\circ\text{C}$ | | 6.05 | kA ² s |
| | | $t = 8,3$ ms; (60 Hz), sine | | $V_R = 0$ V | | 5.89 | kA ² s |
| | | $t = 10$ ms; (50 Hz), sine | | $T_{VJ} = 150^\circ\text{C}$ | | 4.37 | kA ² s |
| | | $t = 8,3$ ms; (60 Hz), sine | | $V_R = 0$ V | | 4.25 | kA ² s |
| C_J | junction capacitance | $V_R = 400$ V; $f = 1$ MHz | | $T_{VJ} = 25^\circ\text{C}$ | | 37 | pF |

| Brake IGBT + Diode | | | | Ratings | | | |
|--------------------|--------------------------------------|--|--------------------------------|---------|----------|---------------|--|
| Symbol | Definition | Conditions | min. | typ. | max. | Unit | |
| V_{CES} | collector emitter voltage | $T_{VJ} = 25^{\circ}\text{C}$ | | | 1200 | V | |
| V_{GES} | max. DC gate voltage | | | | ± 20 | V | |
| V_{GEM} | max. transient gate emitter voltage | | | | ± 30 | V | |
| I_{C25} | collector current | $T_C = 25^{\circ}\text{C}$ | | | 180 | A | |
| I_{C80} | | $T_C = 80^{\circ}\text{C}$ | | | 140 | A | |
| P_{tot} | total power dissipation | $T_C = 25^{\circ}\text{C}$ | | | 500 | W | |
| $V_{CE(sat)}$ | collector emitter saturation voltage | $I_C = 100\text{ A}; V_{GE} = 15\text{ V}$ | | | 1.7 | V | |
| | | | | | 1.9 | V | |
| $V_{GE(th)}$ | gate emitter threshold voltage | $I_C = 4\text{ mA}; V_{GE} = V_{CE}$ | 6 | 6.8 | 7.5 | V | |
| I_{CES} | collector emitter leakage current | $V_{CE} = V_{CES}; V_{GE} = 0\text{ V}$ | | | 0.1 | mA | |
| | | | | | 0.1 | mA | |
| I_{GES} | gate emitter leakage current | $V_{GE} = \pm 20\text{ V}$ | | | 500 | nA | |
| $Q_{G(on)}$ | total gate charge | $V_{CE} = 600\text{ V}; V_{GE} = 15\text{ V}; I_C = 100\text{ A}$ | | 340 | | nC | |
| $t_{d(on)}$ | turn-on delay time | inductive load $V_{CE} = 600\text{ V}; I_C = 100\text{ A}$ $V_{GE} = \pm 15\text{ V}; R_G = 6.8\ \Omega$ | $T_{VJ} = 125^{\circ}\text{C}$ | | 230 | ns | |
| t_r | current rise time | | | | 70 | ns | |
| $t_{d(off)}$ | turn-off delay time | | | | 380 | ns | |
| t_f | current fall time | | | | 230 | ns | |
| E_{on} | turn-on energy per pulse | | | | 12.5 | mJ | |
| E_{off} | turn-off energy per pulse | | | | 11.5 | mJ | |
| RBSOA | reverse bias safe operating area | $V_{GE} = \pm 15\text{ V}; R_G = 6.8\ \Omega$ | | | | | |
| I_{CM} | | $V_{CEK} = 1200\text{ V}$ | | | 300 | A | |
| SCSOA | short circuit safe operating area | $V_{CEK} = 1200\text{ V}$ | | | | | |
| t_{SC} | short circuit duration | $V_{CE} = 720\text{ V}; V_{GE} = \pm 15$ | $T_{VJ} = 125^{\circ}\text{C}$ | | 10 | μs | |
| I_{SC} | short circuit current | $R_G = 6.8\ \Omega$; non-repetitive | | 450 | | A | |
| R_{thJC} | thermal resistance junction to case | | | | 0.25 | K/W | |
| R_{thCH} | thermal resistance case to heatsink | | | | 0.1 | K/W | |
| Brake Diode | | | | | | | |
| V_{RRM} | max. repetitive reverse voltage | | | | 1200 | V | |
| I_{F25} | forward current | | $T_C = 25^{\circ}\text{C}$ | | 48 | A | |
| I_{F80} | | | $T_C = 80^{\circ}\text{C}$ | | 32 | A | |
| V_F | forward voltage | $I_F = 30\text{ A}$ | $T_{VJ} = 25^{\circ}\text{C}$ | | 2.75 | V | |
| | | | $T_{VJ} = 125^{\circ}\text{C}$ | 1.60 | | V | |
| I_R | reverse current | $V_R = V_{RRM}$ | $T_{VJ} = 25^{\circ}\text{C}$ | | 0.25 | mA | |
| | | | $T_{VJ} = 125^{\circ}\text{C}$ | | 1 | mA | |
| Q_{rr} | reverse recovery charge | $V_R = 600\text{ V}$ $-di_f/dt = 1000\text{ A}/\mu\text{s}$ $I_F = 30\text{ A}; V_{GE} = 0\text{ V}$ | $T_{VJ} = 125^{\circ}\text{C}$ | | 5.2 | μC | |
| I_{RM} | max. reverse recovery current | | | | 50 | A | |
| t_{rr} | reverse recovery time | | | | 300 | ns | |
| E_{rec} | reverse recovery energy | | | | 1.9 | mJ | |
| R_{thJC} | thermal resistance junction to case | | | | 0.9 | K/W | |
| R_{thCH} | thermal resistance case to heatsink | | | | 0.1 | K/W | |

| Package E2-Pack | | Ratings | | | | |
|-----------------|--|---|------|------|------|------|
| Symbol | Definition | Conditions | min. | typ. | max. | Unit |
| I_{RMS} | RMS current | per terminal | | | 50 | A |
| T_{VJ} | virtual junction temperature | | -40 | | 150 | °C |
| T_{op} | operation temperature | | -40 | | 125 | °C |
| T_{stg} | storage temperature | | -40 | | 125 | °C |
| Weight | | | | 176 | | g |
| M_D | mounting torque | | 3 | | 6 | Nm |
| $d_{Spp/App}$ | creepage distance on surface / striking distance through air | terminal to terminal | 6.0 | | | mm |
| $d_{Spb/Apb}$ | | terminal to backside | 12.0 | | | mm |
| V_{ISOL} | isolation voltage | t = 1 second 50/60 Hz, RMS; $I_{ISOL} \leq 1$ mA | 3600 | | | V |
| | | t = 1 minute | 3000 | | | V |



| Ordering | Ordering Number | Marking on Product | Delivery Mode | Quantity | Code No. |
|----------|-----------------|--------------------|---------------|----------|----------|
| Standard | VUB145-16NOXT | VUB145-16NOXT | Box | 6 | 521635 |

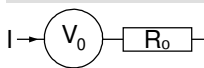
Temperature Sensor NTC

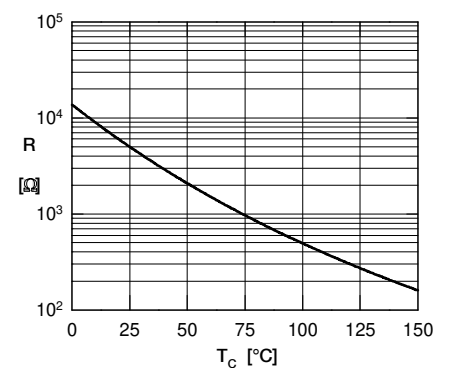
| Symbol | Definition | Conditions | min. | typ. | max. | Unit |
|-------------|-------------------------|---------------------|------|------|------|------------|
| R_{25} | resistance | $T_{VJ} = 25^\circ$ | 4.75 | 5 | 5.25 | k Ω |
| $B_{25/50}$ | temperature coefficient | | | 3375 | | K |

Equivalent Circuits for Simulation

* on die level

$T_{VJ} = 150^\circ\text{C}$

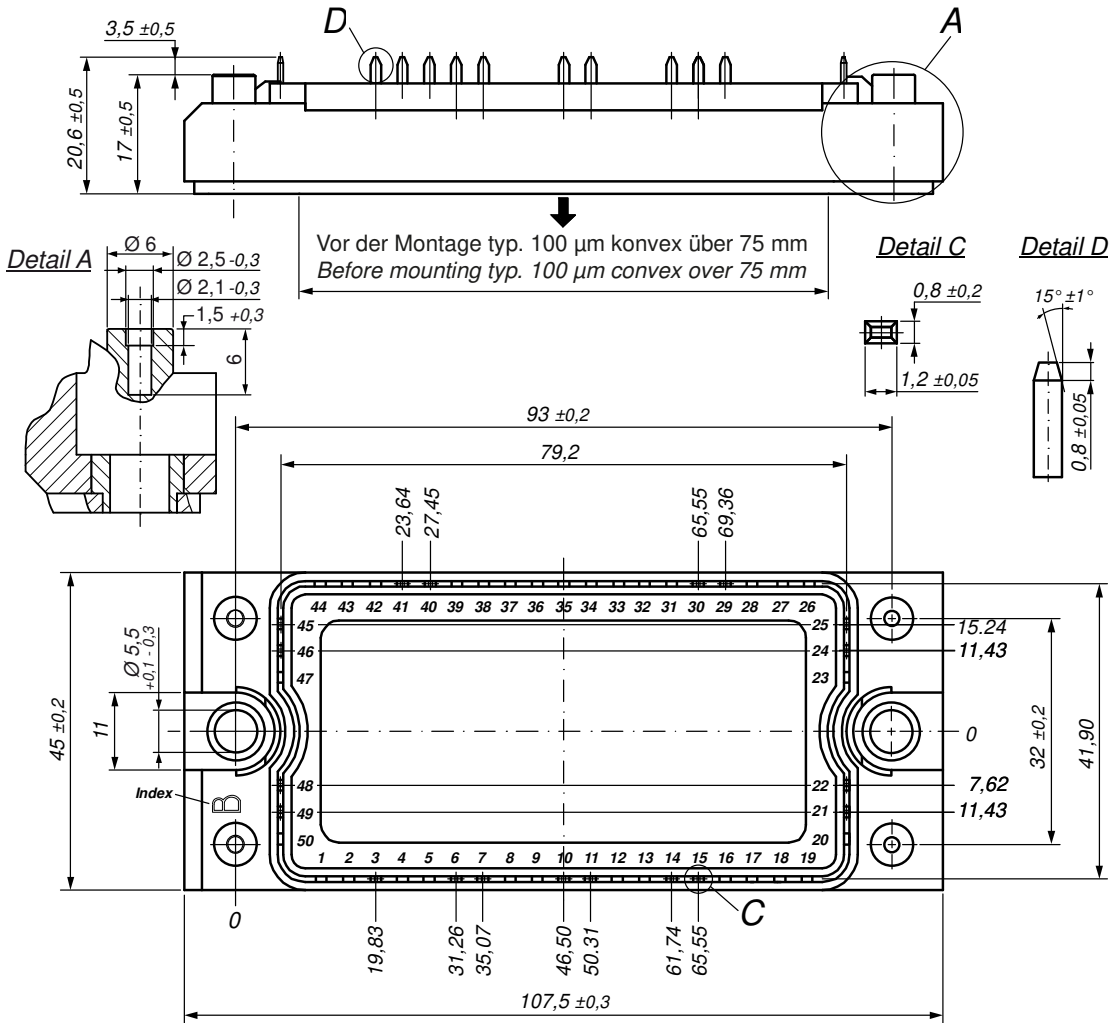
| | Rectifier | Brake Diode | |
|---|-----------|-------------|------------|
|  | | | |
| $V_{0 \max}$ | 0.87 | 1.31 | V |
| $R_{0 \max}$ | 3.3 | 8 | m Ω |



Typ. NTC resistance vs. temperature



Outlines E2-Pack

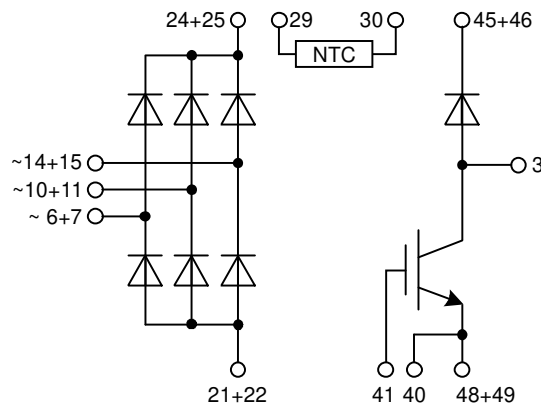


Bemerkung / Note:

- Nichttolerierete Maße nach / Measure without tolerances according DIN ISO 2768-T1-m
- PCB-Lochmuster / PCB hole pattern: **see pin position**
- Toleranz Pin-Position und PCB-Lochmuster / Tolerance of pin position and PCB hole pattern: $\oplus 0.1$
- Montageanleitung / Mounting instruction: www.ixys.com **Application note IXAN0024**

Detail A: PCB-Montage / Mounting on PCB ^L

- Empfohlene, selbstschneidende Schraube / Recommended, self-tapping screw: **EJOT PT®** (Größe / size: **K25**) ^L
- Max. Schraubenlänge / Max. screw length: **PCB-Dicke / thickness + 6 mm** (max. Lochtiefe / hole depth) ^L
- Empfohlenes Drehmoment / Recommended mounting torque: **1.5 Nm**



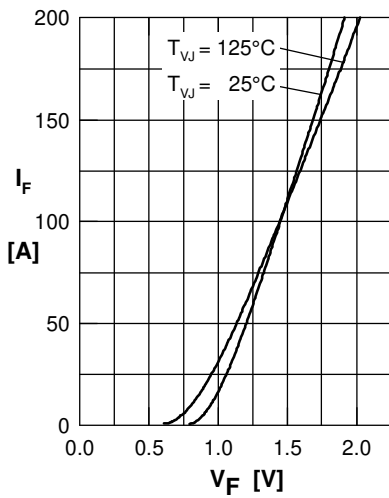
Rectifier


Fig. 1 Forward current vs. voltage drop per diode

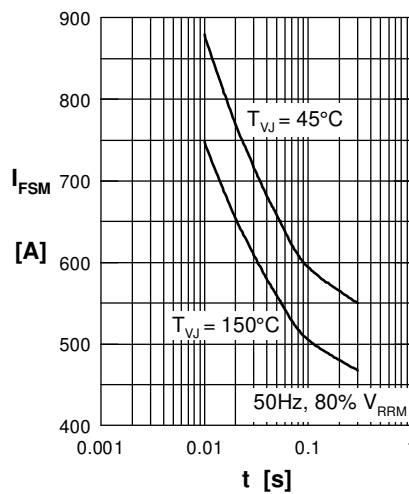


Fig. 2 Surge overload current vs. time per diode

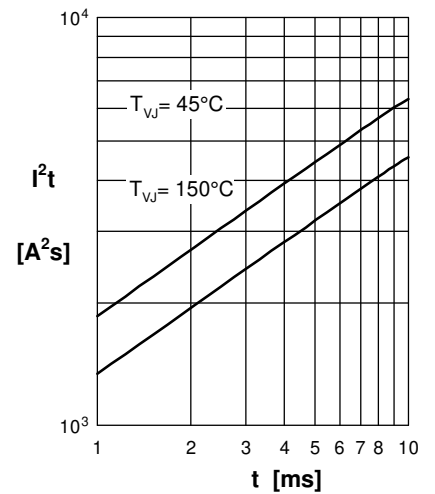
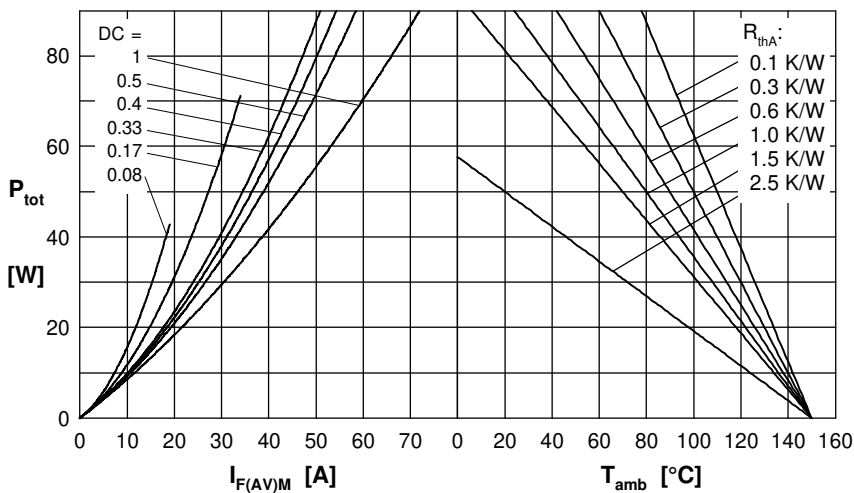

 Fig. 3 I^2t vs. time per diode


Fig. 4 Power dissipation vs. forward current and ambient temperature per diode

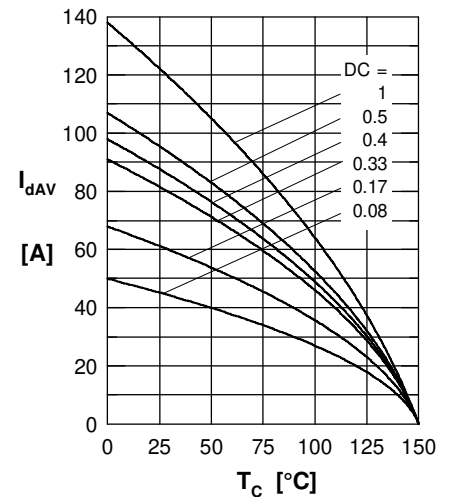


Fig. 5 Max. forward current vs. case temperature per diode

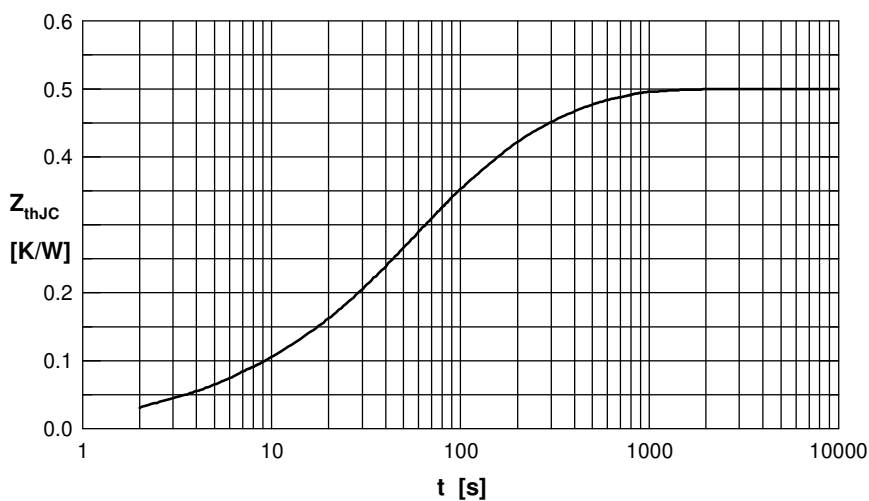


Fig. 6 Transient thermal impedance junction to case vs. time per diode

 Constants for Z_{thJC} calculation:

| i | R_{th} (K/W) | t_i (s) |
|---|----------------|-----------|
| 1 | 0.040 | 0.004 |
| 2 | 0.003 | 0.010 |
| 3 | 0.140 | 0.030 |
| 4 | 0.120 | 0.300 |
| 5 | 0.197 | 0.080 |

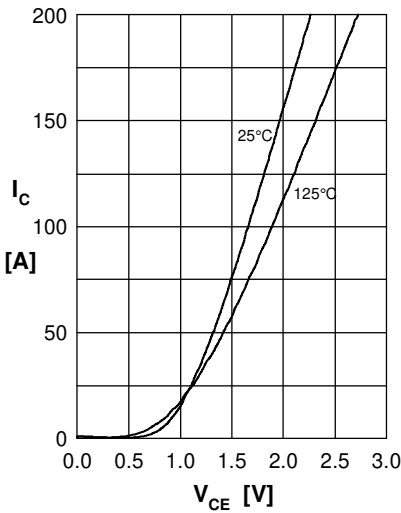
Brake IGBT + Diode


Fig.1 Output characteristics IGBT

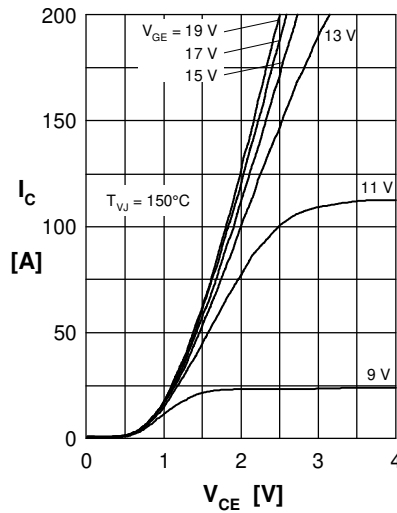


Fig.2 Typ. output characteristics IGBT

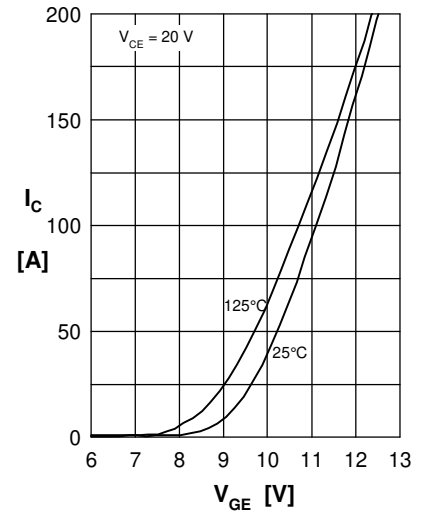


Fig.3 Typ. transfer charact. IGBT

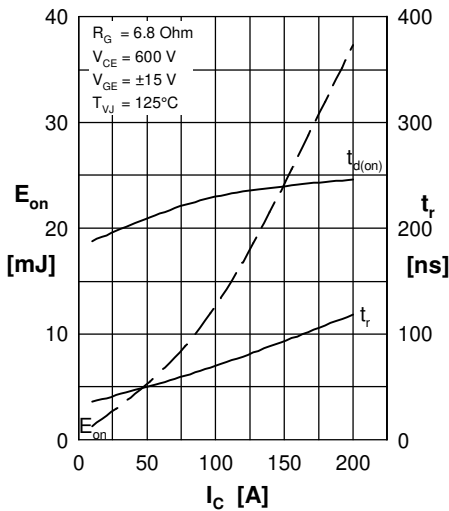


Fig.4 Typ. turn-on energy & switch. times vs. collector current

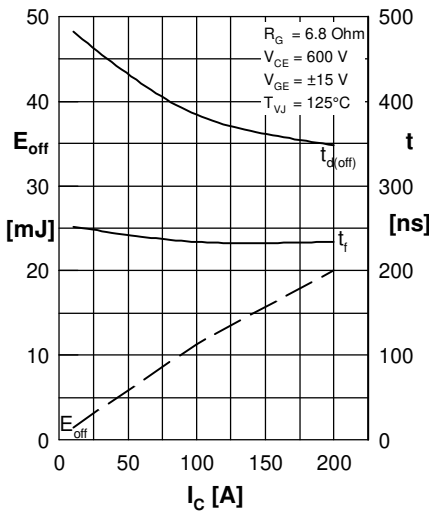


Fig.5 Typ. turn-off energy & switch. times vs. collector current

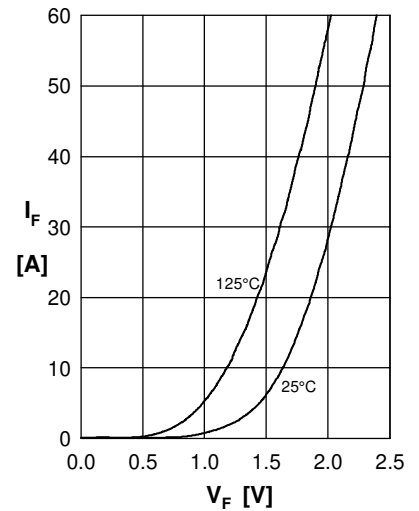


Fig.6 Typ. forward characteristics Diode

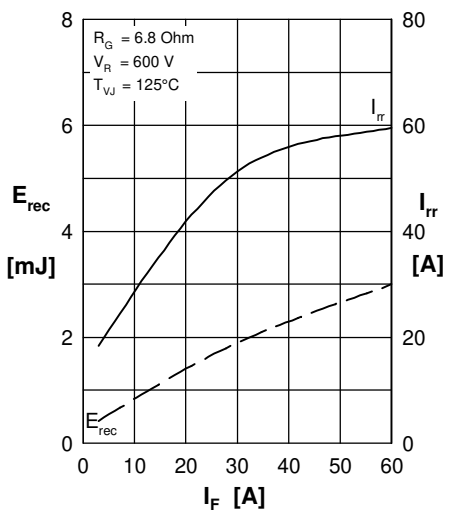


Fig.7 Typ. reverse recovery characteristics Diode

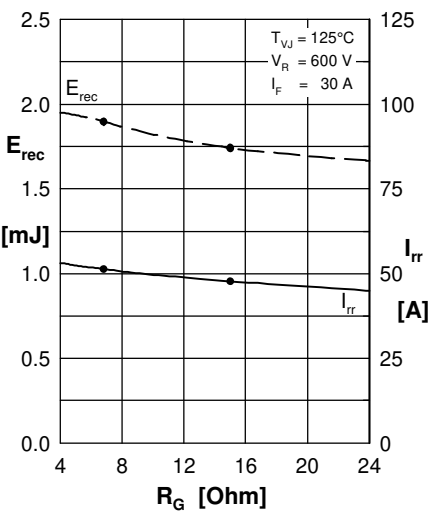


Fig.8 Typ. reverse recovery characteristics Diode

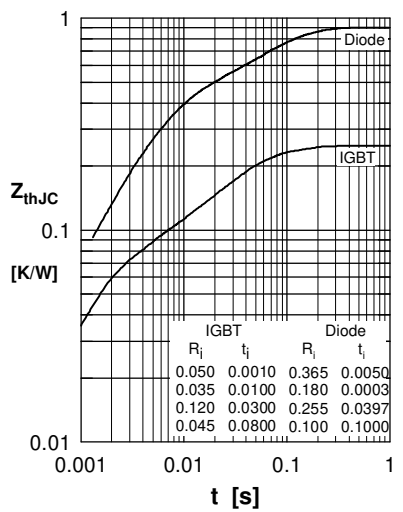


Fig.9 Transient thermal resistance junction to case