

1500V MOS Gated Thyristor

MMJX1H40N150

$V_{DM} = 1500V$

(Electrically Isolated Tab)

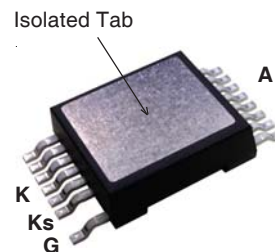
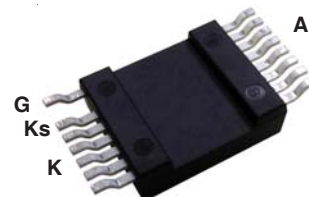
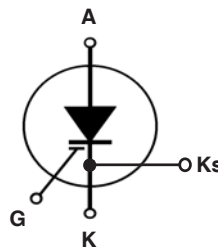

Symbol	Test Conditions	Maximum Ratings	
V_{DM}	$T_J = 25^\circ\text{C to } 150^\circ\text{C}$	1500	V
V_{GK}	Continuous	± 30	V
V_{GK}	Transient	± 40	V
I_{TSM}	$T_C = 25^\circ\text{C}, 1\mu\text{s}$	15.5	kA
	$T_C = 25^\circ\text{C}, 10\mu\text{s}$	6.4	kA
P_D	$T_C = 25^\circ\text{C}$	320	W
T_J		-55 ... +150	$^\circ\text{C}$
T_{JM}		150	$^\circ\text{C}$
T_{stg}		-55 ... +150	$^\circ\text{C}$
T_L	Maximum Lead Temperature for Soldering	300	$^\circ\text{C}$
T_{SOLD}	1.6 mm (0.062 in.) from Case for 10s	260	$^\circ\text{C}$
V_{ISOL}	50/60Hz, 1 minute	2500	V~
F_C	Mounting Force	50..200/11..45	N/lb
Weight		5	g

G = Gate K = Cathode
A = Anode Ks = Cathode Sense

Features

- Silicon Chip on Direct-Copper Bond (DCB) Substrate
- Isolated Mounting Surface
- 2500V~ Electrical Isolation
- Very High Current Capability

Advantages

- High Power Density
- Low Gate Drive Requirement

Applications

- Capacitive Discharge Circuits
- Ignition Circuits
- Solid State Surge Protection

Symbol	Test Conditions ($T_J = 25^\circ\text{C}$, Unless Otherwise Specified)	Characteristic Values		
		Min.	Typ.	Max.
V_{BR}	$I_A = 250\mu\text{A}, V_{GK} = 0V$	1500		V
$V_{GK(th)}$	$I_A = 250\mu\text{A}, V_{AK} = V_{GK}$	2.5		5.0 V
V_T	$I_T = 1000A, V_{GK} = 15V$		4.75	6.0 V
r_T	$I_T > I_L, V_{GK} = 15V$		1.20	m Ω
V_{BO}	$V_{GK} = 15V$		5.25	V
I_D	$V_{AK} = 1500V, V_{GK} = 0V$ $T_J = 125^\circ\text{C}$			15 μA
				1.5 mA
I_L			250	A
I_H			200	A
I_{GKS}	$V_{AK} = 0V, V_{GK} = \pm 30V$			± 200 nA

Symbol	Test Conditions ($T_J = 25^\circ\text{C}$ Unless Otherwise Specified)	Characteristic Values		
		Min.	Typ.	Max.
C_{iks}	$V_{AK} = 25\text{V}, V_{GK} = 0\text{V}, f = 1\text{MHz}$		2825	pF
C_{oks}			164	pF
C_{rks}			50	pF
$Q_{g(on)}$	$I_C = 40\text{A}, V_{GK} = 15\text{V}, V_{AK} = 600\text{V}$		99	nC
Q_{gk}			22	nC
Q_{ga}			36	nC
t_{ri}	Capacitive Discharge, $T_J = 25^\circ\text{C}$ $I_A = 2000\text{A}, V_{GK} = 15\text{V}, R_G = 1\Omega$ $V_{AK} = 1000\text{V}, L < 20\text{nH}, \text{Notes 2 \& 3}$		100	ns
t_d			50	ns
t_{ri}	Capacitive Discharge, $T_J = 125^\circ\text{C}$ $I_A = 2000\text{A}, V_{GK} = 15\text{V}, R_G = 1\Omega$ $V_{AK} = 1000\text{V}, L < 20\text{nH}, \text{Notes 2 \& 3}$		100	ns
t_d			50	ns
R_{thJC}				0.39 °C/W
R_{thCS}		0.12		°C/W
R_{thJA}		30		°C/W

Notes:

1. Pulse test, $t \leq 300\mu\text{s}$, duty cycle, $d \leq 2\%$.
2. It is recommended to use a gate driver capable of supplying more than 4Amps and $\geq 15\text{V}$ gate voltage.
3. Refer to fig. 8 & 9.

IXYS Reserves the Right to Change Limits, Test Conditions, and Dimensions.

IXYS MOSFETs and IGBTs are covered by one or more of the following U.S. patents:	4,835,592	4,931,844	5,049,961	5,237,481	6,162,665	6,404,065 B1	6,683,344	6,727,585	7,005,734 B2	7,157,338B2
	4,860,072	5,017,508	5,063,307	5,381,025	6,259,123 B1	6,534,343	6,710,405 B2	6,759,692	7,063,975 B2	
	4,881,106	5,034,796	5,187,117	5,486,715	6,306,728 B1	6,583,505	6,710,463	6,771,478 B2	7,071,537	

Fig. 1. Extended Output Characteristics @ $T_J = 25^\circ\text{C}$

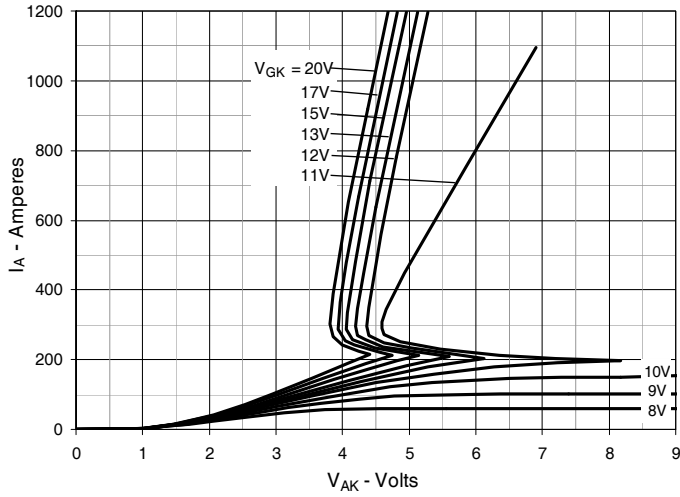

Fig. 2. Extended Output Characteristics @ $T_J = 125^\circ\text{C}$

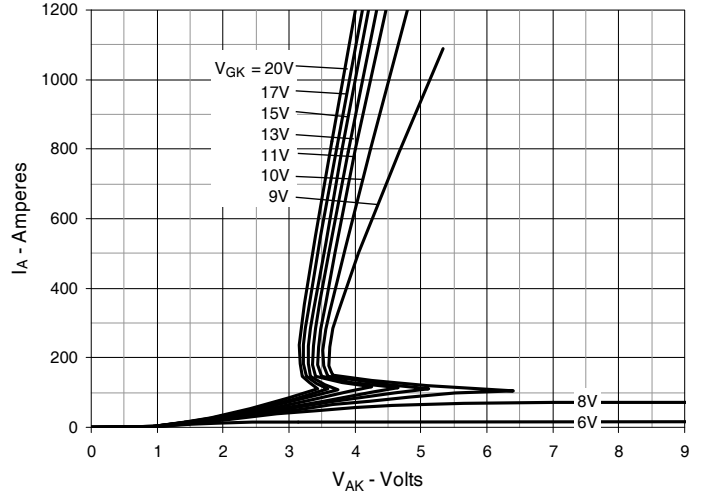

Fig. 3. Extended Output Characteristics @ $T_J = -40^\circ\text{C}$

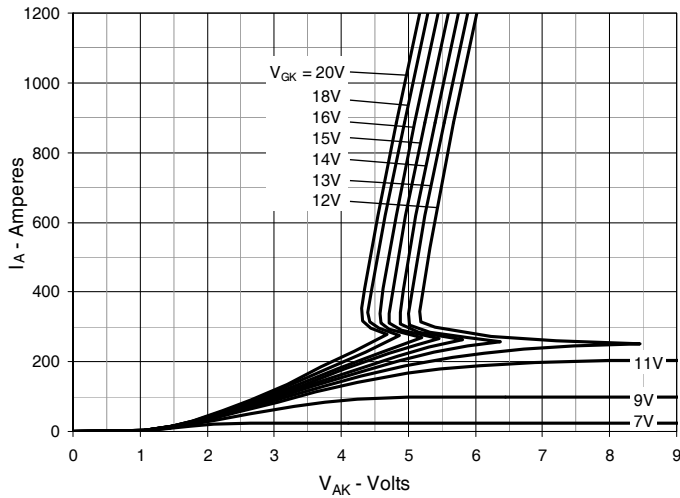

Fig. 4. Gate Charge

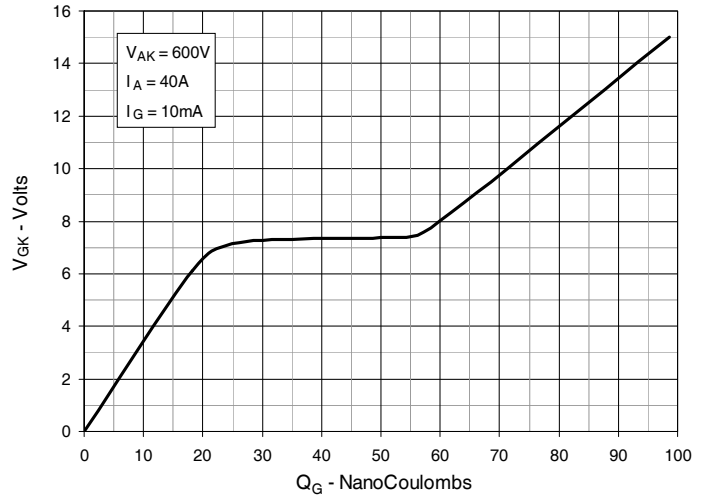

Fig. 5. Capacitance

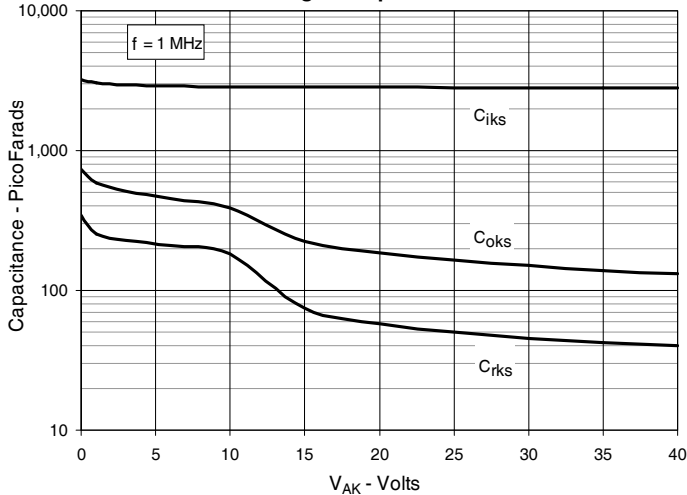

Fig. 6. Maximum Transient Thermal Impedance

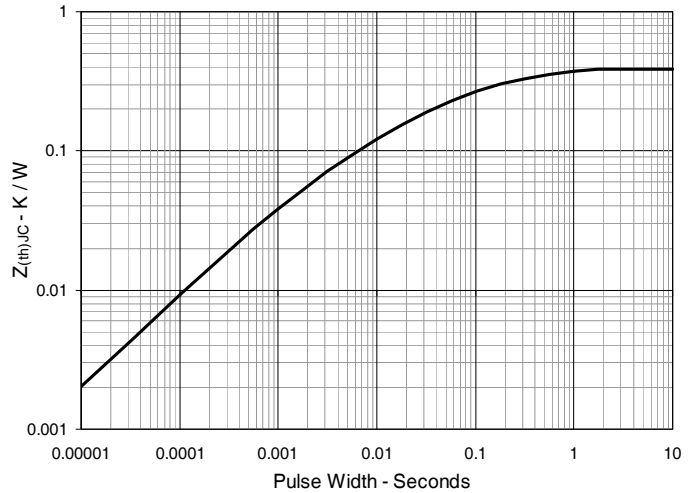
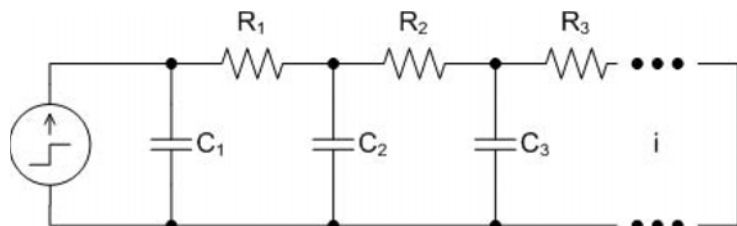

Fig. 7. Cauer Thermal Network



i	Ri (Ω)	Ci (F)
1	0.014083	0.0078555
2	0.068078	0.0196550
3	0.133430	0.1199600
4	0.121939	2.5000000

Fig. 8. Capacitive Discharge

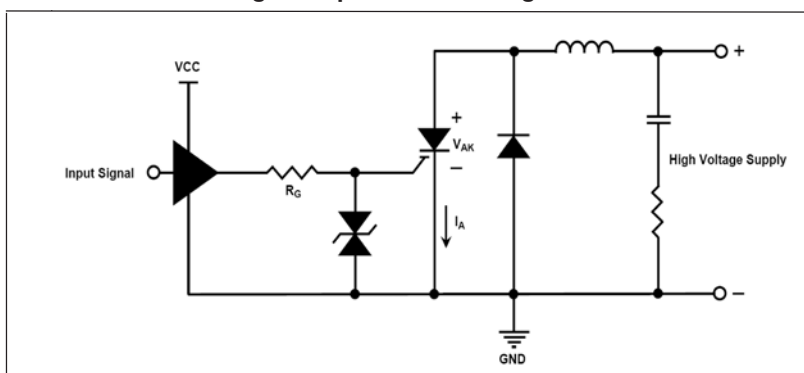
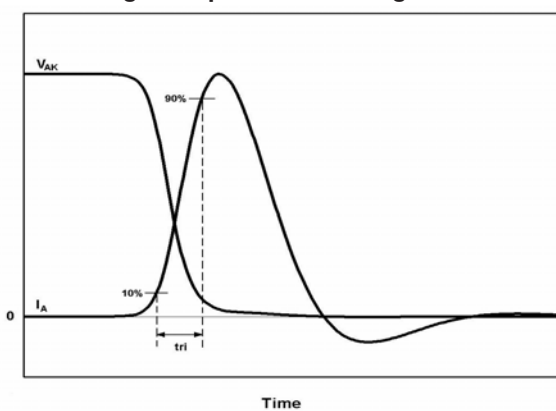
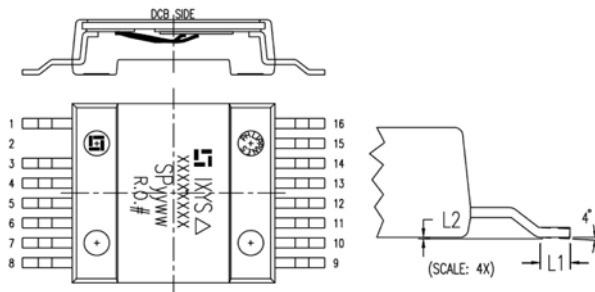
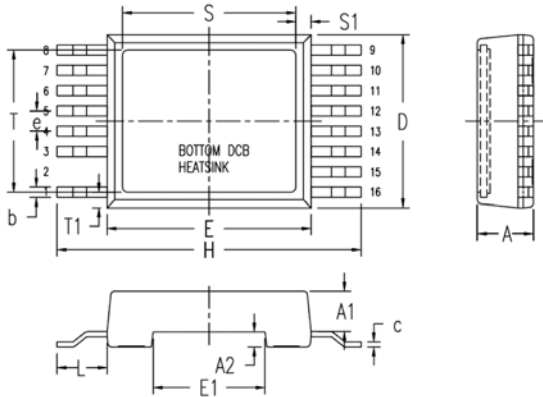

Fig. 9. Capacitive Discharge Waveform





SYM	INCHES		MILLIMETERS	
	MIN	MAX	MIN	MAX
A	.209	.224	5.30	5.70
A1	.154	.161	3.90	4.10
A2	.055	.063	1.40	1.60
b	.035	.045	0.90	1.15
c	.018	.026	0.45	0.65
D	.661	.677	16.80	17.20
E	.780	.795	19.80	20.20
E1	.425	.441	10.80	11.20
e	.079 BSC		2.00 BSC	
H	1.161	1.185	29.50	30.10
L	.181	.209	4.60	5.30
L1	.051	.067	1.30	1.70
L2	.000	.006	0.00	0.15
S	.661	.677	16.80	17.20
S1	.051	.067	1.30	1.70
T	.543	.559	13.80	14.20
T1	.051	.067	1.30	1.70

NOTE:

1. ALL LEADS ARE MATTE PURE TIN PLATED.
2. CU SURFACE OF BOTTOM DCB IS PRE-NI PLATED UNLESS OTHERWISE.
3. CU SURFACE OF BOTTOM DCB IS ELECTRICALLY ISOLATED 2,500V AC FROM ALL OTHER LEADS.
4. UNLESS OTHER SPECIFIED, PIN OUT ARE AS FOLLOWS.

PINS:

- 1 - GATE
- 3 - Ks = Cathode Sense
- 4 - 8 - K = Cathode
- 9 - 16 - A = Anode



Disclaimer Notice - Information furnished is believed to be accurate and reliable. However, users should independently evaluate the suitability of and test each product selected for their own applications. Littelfuse products are not designed for, and may not be used in, all applications. Read complete Disclaimer Notice at www.littelfuse.com/disclaimer-electronics.