



Standard Rectifier

$$V_{RRM} = 2 \times 1200 \text{ V}$$

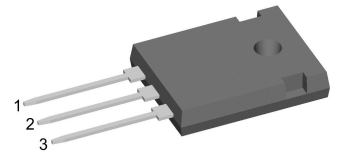
$$I_{FAV} = 25 \text{ A}$$

$$V_F = 1.16 \text{ V}$$

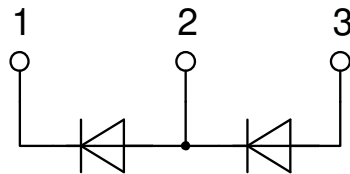
Phase leg

Part number

DSP25-12A



Backside: anode/cathode



Features / Advantages:

- Planar passivated chips
- Very low leakage current
- Very low forward voltage drop
- Improved thermal behaviour

Applications:

- Diode for main rectification
- For single and three phase bridge configurations

Package: TO-247

- Industry standard outline
- RoHS compliant
- Epoxy meets UL 94V-0

Disclaimer Notice

Information furnished is believed to be accurate and reliable. However, users should independently evaluate the suitability of and test each product selected for their own applications. Littelfuse products are not designed for, and may not be used in, all applications. Read complete Disclaimer Notice at www.littelfuse.com/disclaimer-electronics.



Rectifier				Ratings			
Symbol	Definition	Conditions	min.	typ.	max.	Unit	
V_{RSM}	max. non-repetitive reverse blocking voltage				1300	V	
V_{RRM}	max. repetitive reverse blocking voltage				1200	V	
I_R	reverse current	$V_R = 1200\text{ V}$			40	μA	
		$V_R = 1200\text{ V}$			1.5	mA	
V_F	forward voltage drop	$I_F = 25\text{ A}$			1.23	V	
		$I_F = 50\text{ A}$			1.47	V	
		$I_F = 25\text{ A}$			1.16	V	
		$I_F = 50\text{ A}$			1.50	V	
I_{FAV}	average forward current	$T_C = 135^\circ\text{C}$			25	A	
		180° sine					
V_{FO}	threshold voltage	} for power loss calculation only			0.81	V	
r_F	slope resistance				13.8	m Ω	
R_{thJC}	thermal resistance junction to case				0.9	K/W	
R_{thCH}	thermal resistance case to heatsink			0.3		K/W	
P_{tot}	total power dissipation				160	W	
I_{FSM}	max. forward surge current	t = 10 ms; (50 Hz), sine			300	A	
		t = 8,3 ms; (60 Hz), sine			325	A	
		t = 10 ms; (50 Hz), sine			255	A	
		t = 8,3 ms; (60 Hz), sine			275	A	
I^2t	value for fusing	t = 10 ms; (50 Hz), sine			450	A ² s	
		t = 8,3 ms; (60 Hz), sine			440	A ² s	
		t = 10 ms; (50 Hz), sine			325	A ² s	
		t = 8,3 ms; (60 Hz), sine			315	A ² s	
C_J	junction capacitance	$V_R = 400\text{ V}; f = 1\text{ MHz}$		10		pF	



Package TO-247			Ratings			
Symbol	Definition	Conditions	min.	typ.	max.	Unit
I_{RMS}	RMS current	per terminal			70	A
T_{VJ}	virtual junction temperature		-40		175	°C
T_{op}	operation temperature		-40		150	°C
T_{stg}	storage temperature		-40		150	°C
Weight				6		g
M_D	mounting torque		0.8		1.2	Nm
F_C	mounting force with clip		20		120	N

Product Marking



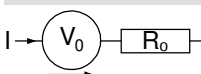
Ordering	Ordering Number	Marking on Product	Delivery Mode	Quantity	Code No.
Standard	DSP25-12A	DSP25-12A	Tube	30	463604

Similar Part	Package	Voltage class
DSP25-12AT	TO-268AA (D3Pak) (2)	1200
DSP25-16A	TO-247AD (3)	1600
DSP25-16AR	ISOPLUS247 (3)	1600
DSP25-16AT	TO-268AA (D3Pak) (2)	1600

Equivalent Circuits for Simulation

** on die level*

$T_{VJ} = 175^{\circ}C$

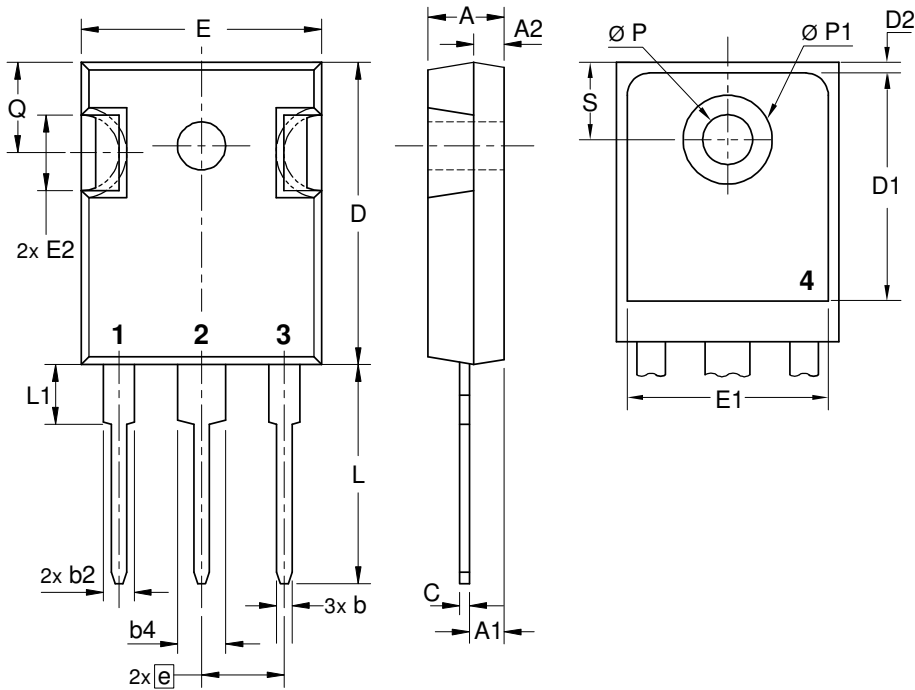


Rectifier

$V_{0\ max}$	threshold voltage	0.81	V
$R_{0\ max}$	slope resistance *	11.2	mΩ



Outlines TO-247



Sym.	Inches		Millimeter	
	min.	max.	min.	max.
A	0.185	0.209	4.70	5.30
A1	0.087	0.102	2.21	2.59
A2	0.059	0.098	1.50	2.49
D	0.819	0.845	20.79	21.45
E	0.610	0.640	15.48	16.24
E2	0.170	0.216	4.31	5.48
e	0.215 BSC		5.46 BSC	
L	0.780	0.800	19.80	20.30
L1	-	0.177	-	4.49
Ø P	0.140	0.144	3.55	3.65
Q	0.212		5.38	
S	0.242 BSC		6.14 BSC	
b	0.039	0.055	0.99	1.40
b2	0.065	0.094	1.65	2.39
b4	0.102	0.135	2.59	3.43
c	0.015	0.035	0.38	0.89
D1	0.515	-	13.07	-
D2	0.020	0.053	0.51	1.35
E1	0.530	-	13.45	-
Ø P1	-	0.29	-	7.39



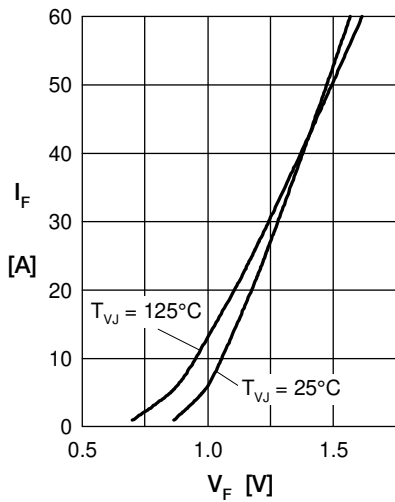
Rectifier


Fig. 1 Forward current versus voltage drop per diode

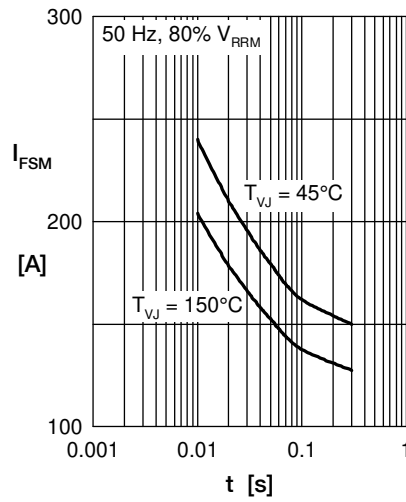


Fig. 2 Surge overload current

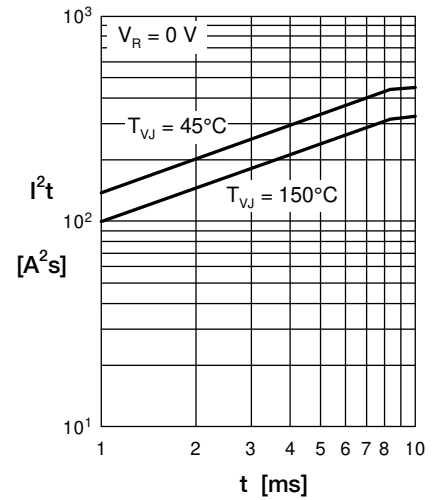
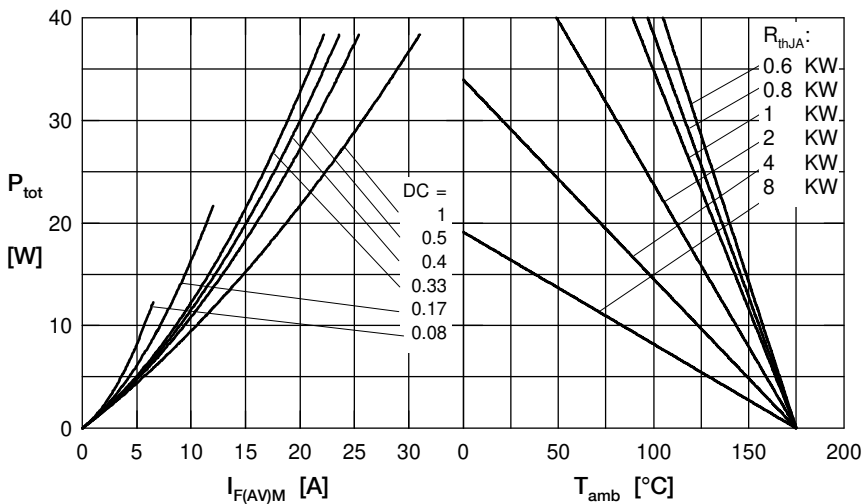

 Fig. 3 I^2t versus time per diode


Fig. 4 Power dissipation vs. direct output current and ambient temperature

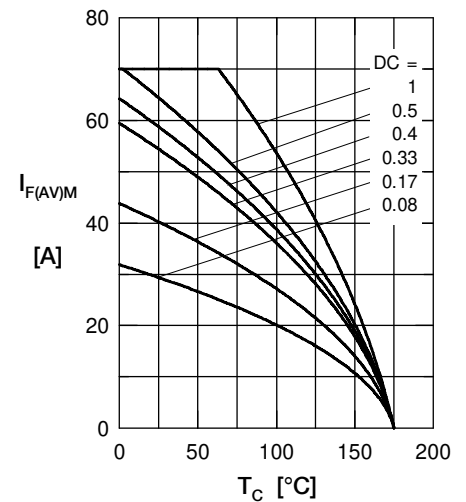


Fig. 5 Max. forward current vs. case temperature

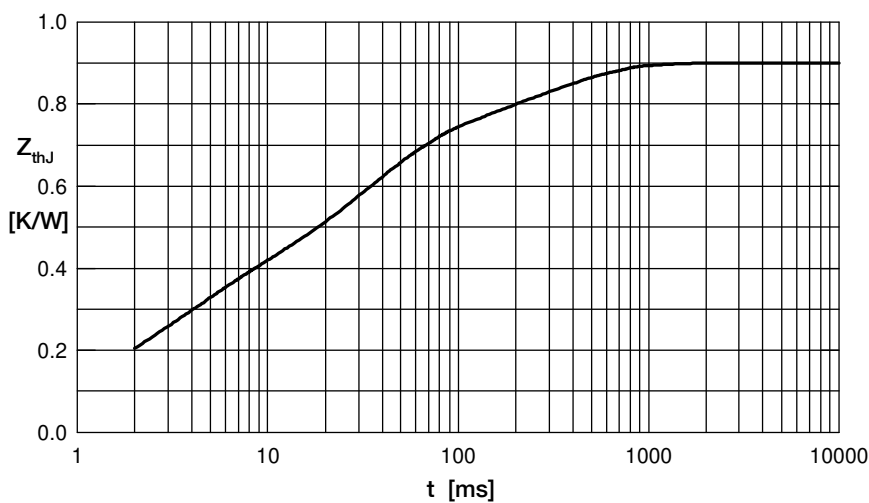


Fig. 6 Transient thermal impedance junction to case

 Constants for Z_{thJC} calculation:

i	R_{thi} (K/W)	t_i (s)
1	0.03	0.0004
2	0.08	0.002
3	0.2	0.003
4	0.39	0.03
5	0.2	0.29