

**PolarP™**  
**Power MOSFETs**

**IXTT48P20P**  
**IXTH48P20P**

$V_{DSS} = -200V$   
 $I_{D25} = -48A$   
 $R_{DS(on)} \leq 85m\Omega$

P-Channel Enhancement Mode  
Avalanche Rated

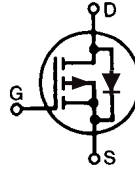

TO-268 (IXTT)

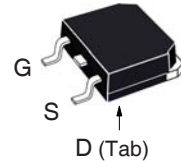

TO-247 (IXTH)

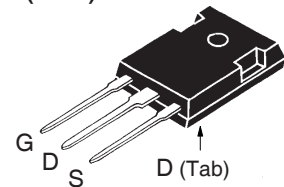

G = Gate      D = Drain  
S = Source    Tab = Drain

Symbol	Test Conditions	Maximum Ratings	
$V_{DSS}$	$T_J = 25^\circ C$ to $150^\circ C$	- 200	V
$V_{DGR}$	$T_J = 25^\circ C$ to $150^\circ C$ , $R_{GS} = 1M\Omega$	- 200	V
$V_{GSS}$	Continuous	$\pm 20$	V
$V_{GSM}$	Transient	$\pm 30$	V
$I_{D25}$	$T_C = 25^\circ C$	- 48	A
$I_{DM}$	$T_C = 25^\circ C$ , Pulse Width Limited by $T_{JM}$	-144	A
$I_A$	$T_C = 25^\circ C$	- 48	A
$E_{AS}$	$T_C = 25^\circ C$	2.5	J
dv/dt	$I_S \leq I_{DM}$ , $V_{DD} \leq V_{DSS}$ , $T_J \leq 150^\circ C$	10	V/ns
$P_D$	$T_C = 25^\circ C$	462	W
$T_J$		- 55 ... +150	$^\circ C$
$T_{JM}$		150	$^\circ C$
$T_{stg}$		- 55 ... +150	$^\circ C$
$T_L$	1.6mm (0.062 in.) from Case for 10s	300	$^\circ C$
$T_{SOLD}$	Plastic Body for 10s	260	$^\circ C$
$M_d$	Mounting Torque (TO-247)	1.13 / 10	Nm/lb.in.
Weight	TO-268	4	g
	TO-247	6	g

**Features**

- International Standard Packages
- Rugged PolarP™ Process
- Avalanche Rated
- Low Package Inductance
- Fast intrinsic Diode

**Advantages**

- Easy to Mount
- Space Savings
- High Power Density

**Applications**

- High-Side Switches
- Push Pull Amplifiers
- DC Choppers
- Automatic Test Equipment
- Current Regulators

Symbol	Test Conditions ( $T_J = 25^\circ C$ , Unless Otherwise Specified)	Characteristic Values		
		Min.	Typ.	Max.
$BV_{DSS}$	$V_{GS} = 0V$ , $I_D = -250\mu A$	- 200		V
$V_{GS(th)}$	$V_{DS} = V_{GS}$ , $I_D = -250\mu A$	- 2.0		V
$I_{GSS}$	$V_{GS} = \pm 20V$ , $V_{DS} = 0V$			$\pm 100$ nA
$I_{DSS}$	$V_{DS} = V_{DSS}$ , $V_{GS} = 0V$ $T_J = 125^\circ C$			- 25 $\mu A$ - 200 $\mu A$
$R_{DS(on)}$	$V_{GS} = -10V$ , $I_D = 0.5 \cdot I_{D25}$ , Note 1			85 m $\Omega$

Symbol	Test Conditions ( $T_J = 25^\circ\text{C}$ , Unless Otherwise Specified)	Characteristic Values		
		Min.	Typ.	Max.
$g_{fs}$	$V_{DS} = -10\text{V}$ , $I_D = 0.5 \cdot I_{D25}$ , Note 1	19	32	S
$C_{iss}$	$V_{GS} = 0\text{V}$ , $V_{DS} = -25\text{V}$ , $f = 1\text{MHz}$		5400	pF
$C_{oss}$			1040	pF
$C_{rss}$			170	pF
$t_{d(on)}$	<b>Resistive Switching Times</b> $V_{GS} = -10\text{V}$ , $V_{DS} = 0.5 \cdot V_{DSS}$ , $I_D = 0.5 \cdot I_{D25}$ $R_G = 3\Omega$ (External)		30	ns
$t_r$			46	ns
$t_{d(off)}$			67	ns
$t_f$			27	ns
$Q_{g(on)}$	$V_{GS} = -10\text{V}$ , $V_{DS} = 0.5 \cdot V_{DSS}$ , $I_D = 0.5 \cdot I_{D25}$		103	nC
$Q_{gs}$			23	nC
$Q_{gd}$			40	nC
$R_{thJC}$				$0.27^\circ\text{C/W}$
$R_{thCS}$	TO-247	0.21		$^\circ\text{C/W}$

### Safe Operating Area Specification

Symbol	Test Conditions	Characteristic Values		
		Min.	Typ.	Max.
SOA	$V_{DS} = -200\text{V}$ , $I_D = -1.35\text{A}$ , $T_C = 70^\circ\text{C}$ , $T_p = 5\text{s}$	270		W

### Source-Drain Diode

Symbol	Test Conditions ( $T_J = 25^\circ\text{C}$ , Unless Otherwise Specified)	Characteristic Values		
		Min.	Typ.	Max.
$I_S$	$V_{GS} = 0\text{V}$			-48 A
$I_{SM}$	Repetitive, Pulse Width Limited by $T_{JM}$			-192 A
$V_{SD}$	$I_F = -24\text{A}$ , $V_{GS} = 0\text{V}$ , Note 1			-3.3 V
$t_{rr}$	$I_F = -24\text{A}$ , $-di/dt = -100\text{A}/\mu\text{s}$ $V_R = -100\text{V}$ , $V_{GS} = 0\text{V}$		260	ns
$Q_{RM}$			4.2	$\mu\text{C}$
$I_{RM}$			-32.2	A

Note 1. Pulse test,  $t \leq 300\mu\text{s}$ , duty cycle,  $d \leq 2\%$ .

### TO-268 Outline

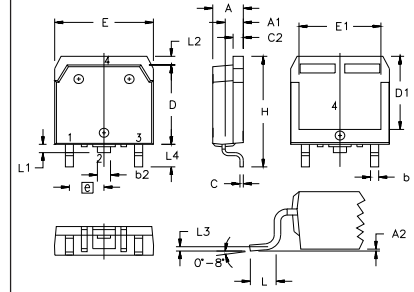

Terminals: 1 - Gate, 2,4 - Drain, 3 - Source

SYM	INCHES		MILLIMETERS	
	MIN	MAX	MIN	MAX
A	.193	.201	4.90	5.10
A1	.106	.114	2.70	2.90
A2	.001	.010	0.02	0.25
b	.045	.057	1.15	1.45
b2	.075	.083	1.90	2.10
C	.016	.026	0.40	0.65
C2	.057	.063	1.45	1.60
D	.543	.551	13.80	14.00
D1	.488	.500	12.40	12.70
E	.624	.632	15.85	16.05
E1	.524	.535	13.30	13.60
e	.215 BSC		5.45 BSC	
H	.736	.752	18.70	19.10
L	.094	.106	2.40	2.70
L1	.047	.055	1.20	1.40
L2	.039	.045	1.00	1.15
L3	.010 BSC		0.25 BSC	
L4	.150	.161	3.80	4.10

### TO-247 Outline

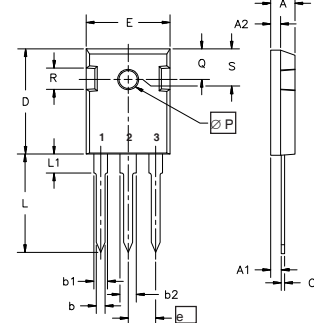

Terminals: 1 - Gate, 2 - Drain, 3 - Source

Dim.	Millimeter		Inches	
	Min.	Max.	Min.	Max.
A	4.7	5.3	.185	.209
A <sub>1</sub>	2.2	2.54	.087	.102
A <sub>2</sub>	2.2	2.6	.059	.098
b	1.0	1.4	.040	.055
b <sub>1</sub>	1.65	2.13	.065	.084
b <sub>2</sub>	2.87	3.12	.113	.123
C	.4	.8	.016	.031
D	20.80	21.46	.819	.845
E	15.75	16.26	.610	.640
e	5.20	5.72	0.205	0.225
L	19.81	20.32	.780	.800
L1		4.50		.177
∅P	3.55	3.65	.140	.144
Q	5.89	6.40	0.232	0.252
R	4.32	5.49	.170	.216
S	6.15 BSC		242 BSC	

IXYS Reserves the Right to Change Limits, Test Conditions, and Dimensions.

IXYS MOSFETs and IGBTs are covered by one or more of the following U.S. patents:

4,835,592	4,931,844	5,049,961	5,237,481	6,162,665	6,404,065 B1	6,683,344	6,727,585	7,005,734 B2	7,157,338B2
4,860,072	5,017,508	5,063,307	5,381,025	6,259,123 B1	6,534,343	6,710,405 B2	6,759,692	7,063,975 B2	
4,881,106	5,034,796	5,187,117	5,486,715	6,306,728 B1	6,583,505	6,710,463	6,771,478 B2	7,071,537	

Fig. 1. Output Characteristics @  $T_J = 25^\circ\text{C}$

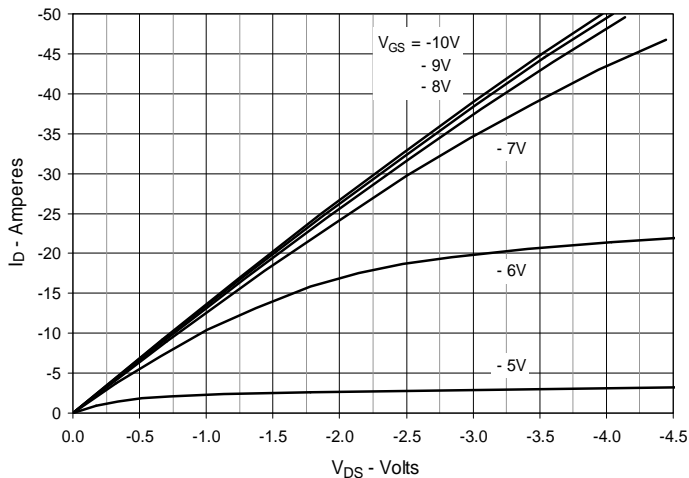

Fig. 2. Extended Output Characteristics @  $T_J = 25^\circ\text{C}$

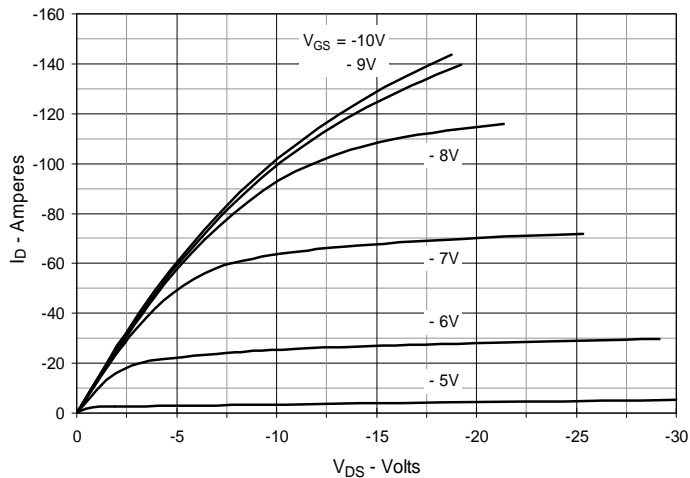

Fig. 3. Output Characteristics @  $T_J = 125^\circ\text{C}$

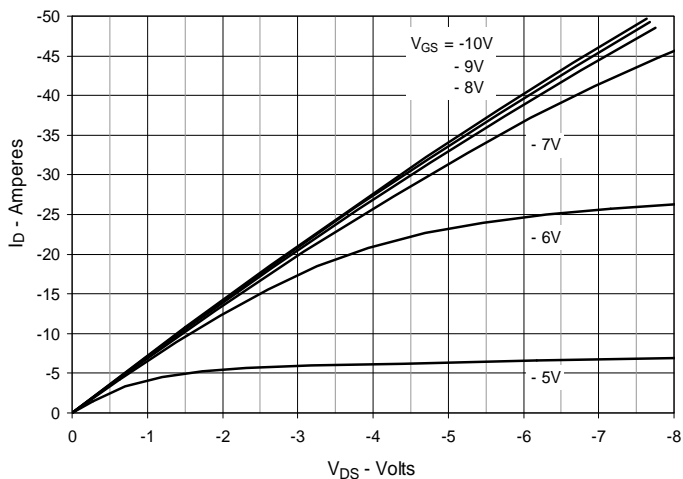

Fig. 4.  $R_{DS(on)}$  Normalized to  $I_D = -24\text{A}$  Value vs. Junction Temperature

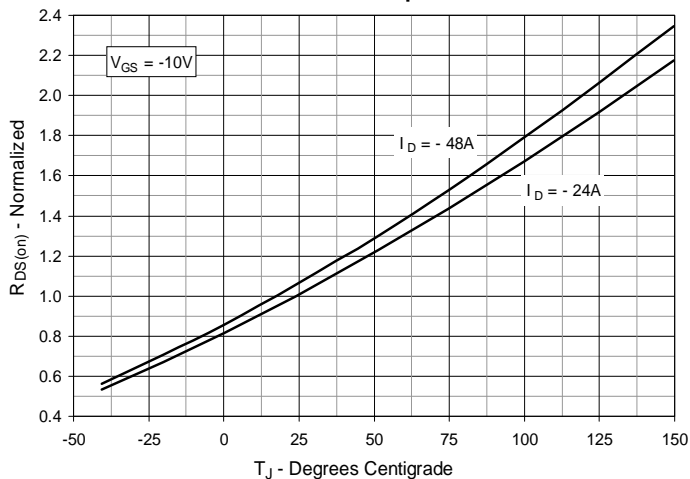

Fig. 5.  $R_{DS(on)}$  Normalized to  $I_D = -24\text{A}$  Value vs. Drain Current

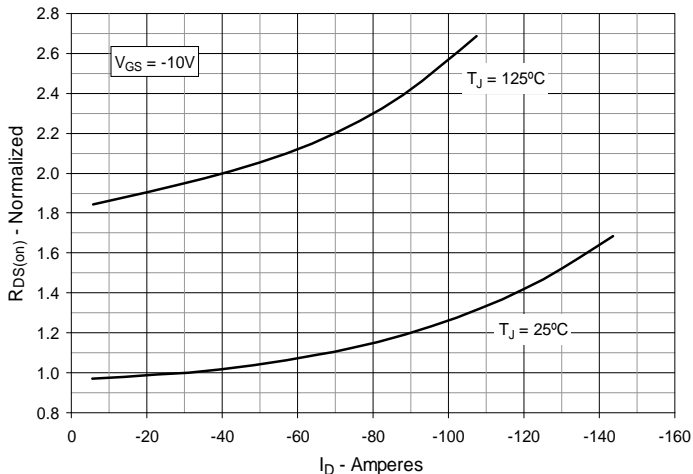
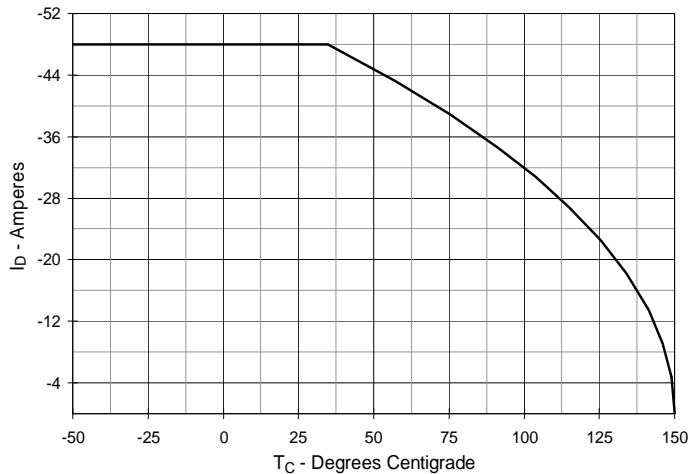
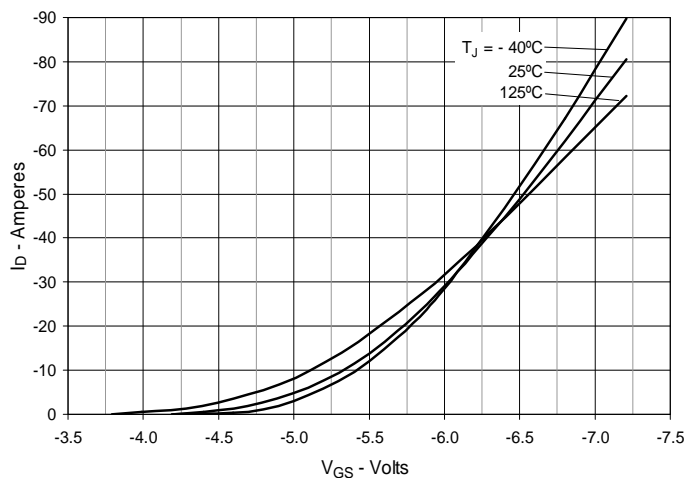

Fig. 6. Maximum Drain Current vs. Case Temperature



**Fig. 7. Input Admittance**



**Fig. 8. Transconductance**

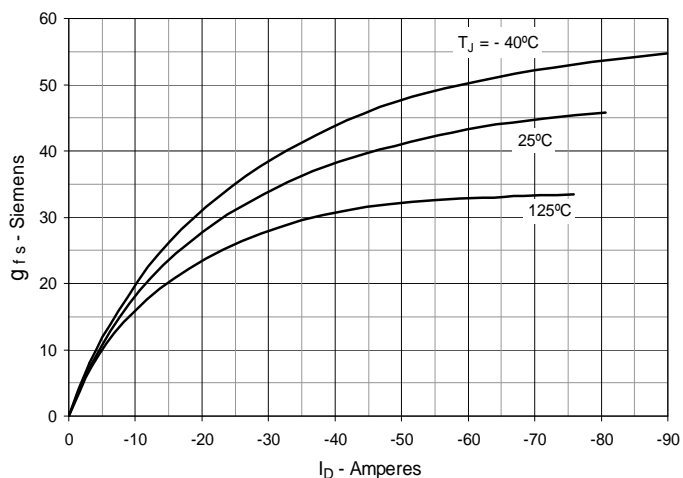

**Fig. 9. Forward Voltage Drop of Intrinsic Diode**

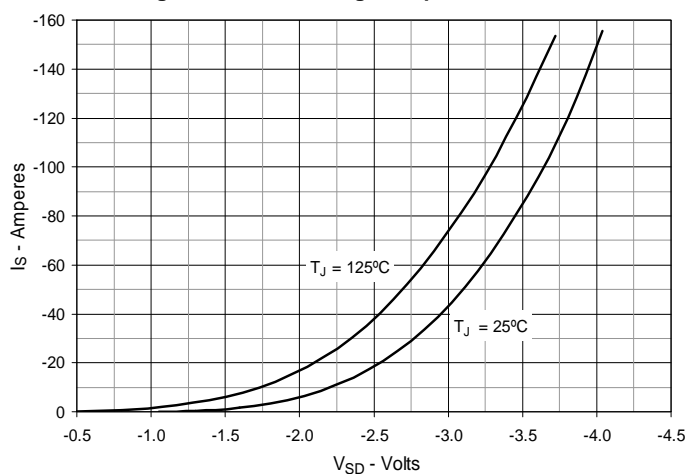

**Fig. 10. Gate Charge**

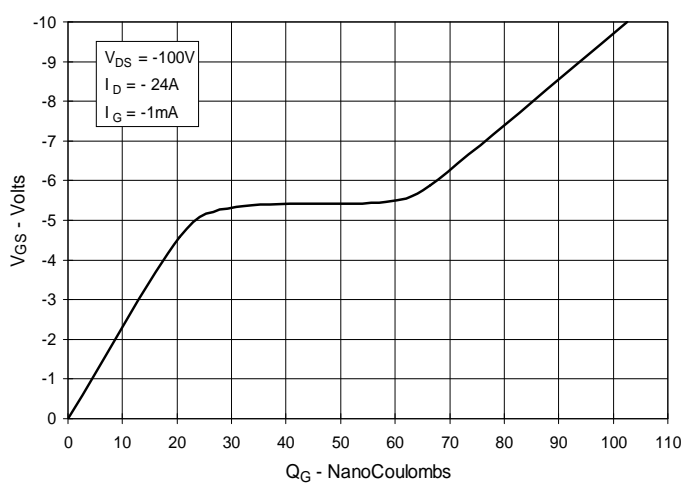

**Fig. 11. Capacitance**

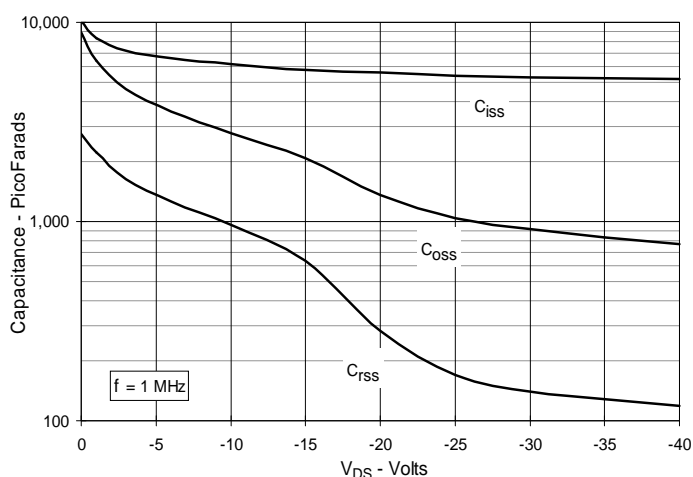

**Fig. 12. Maximum Transient Thermal Impedance**

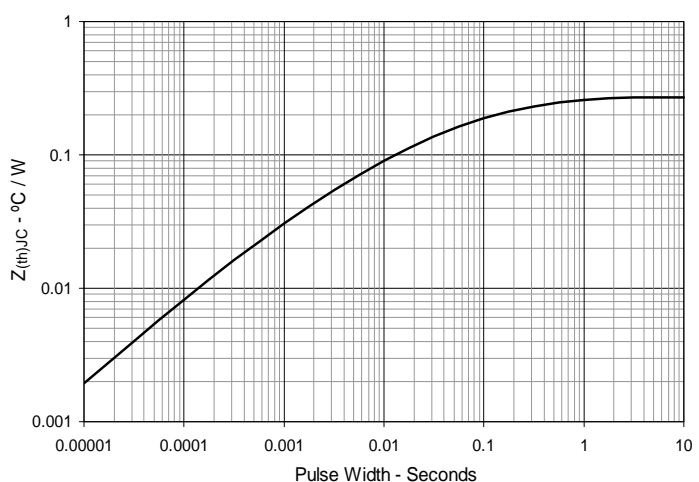

**Fig. 13. Forward-Bias Safe Operating Area**  
@  $T_C = 25^\circ\text{C}$

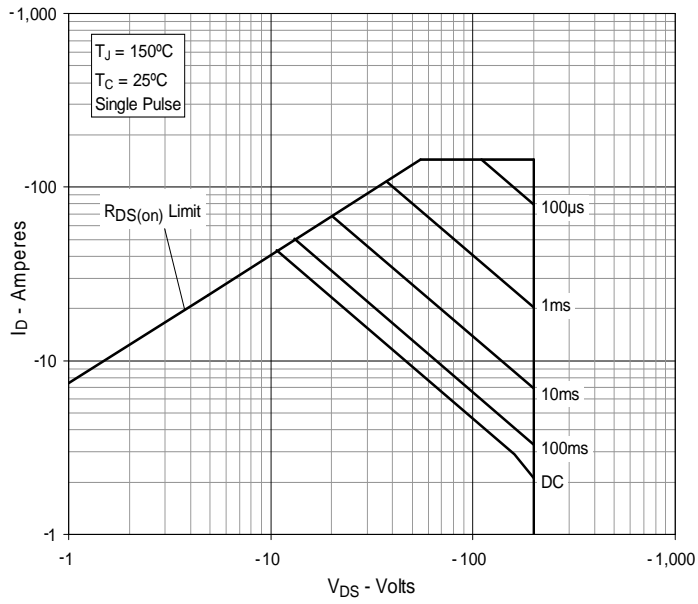

**Fig. 14. Forward-Bias Safe Operating Area**  
@  $T_C = 70^\circ\text{C}$

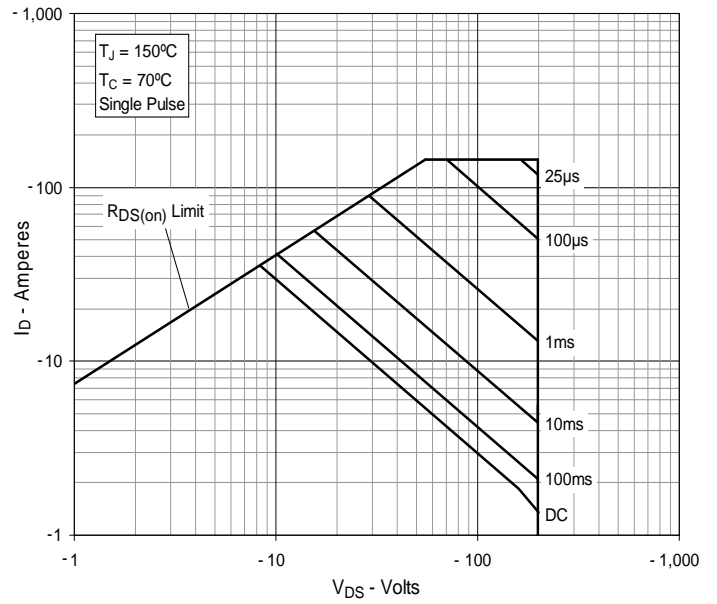



---

Disclaimer Notice - Information furnished is believed to be accurate and reliable. However, users should independently evaluate the suitability of and test each product selected for their own applications. Littelfuse products are not designed for, and may not be used in, all applications. Read complete Disclaimer Notice at [www.littelfuse.com/disclaimer-electronics](http://www.littelfuse.com/disclaimer-electronics).