

**Polar™ Power MOSFET**  
**HiPerFET™**

**IXFK64N50P**  
**IXFX64N50P**

$V_{DSS} = 500V$   
 $I_{D25} = 64A$   
 $R_{DS(on)} \leq 85m\Omega$   
 $t_{rr} \leq 200ns$

N-Channel Enhancement Mode  
Avalanche Rated  
Fast Intrinsic Diode

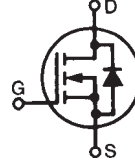

Symbol	Test Conditions	Maximum Ratings	
$V_{DSS}$	$T_J = 25^\circ C$ to $150^\circ C$	500	V
$V_{DGR}$	$T_J = 25^\circ C$ to $150^\circ C$ , $R_{GS} = 1M\Omega$	500	V
$V_{GSS}$	Continuous	$\pm 30$	V
$V_{GSM}$	Transient	$\pm 40$	V
$I_{D25}$	$T_C = 25^\circ C$	64	A
$I_{DM}$	$T_C = 25^\circ C$ , Pulse Width Limited by $T_{JM}$	150	A
$I_A$	$T_C = 25^\circ C$	64	A
$E_{AS}$	$T_C = 25^\circ C$	2.5	J
$dV/dt$	$I_S \leq I_{DM}$ , $V_{DD} \leq V_{DSS}$ , $T_J \leq 150^\circ C$	20	V/ns
$P_D$	$T_C = 25^\circ C$	830	W
$T_J$		-55 ... +150	$^\circ C$
$T_{JM}$		150	$^\circ C$
$T_{stg}$		-55 ... +150	$^\circ C$
$T_L$	1.6mm (0.062 in.) from Case for 10s	300	$^\circ C$
$T_{SOLD}$	Plastic Body for 10s	260	$^\circ C$
$M_d$	Mounting Force (PLUS247) Mounting Torque (TO-264)	20..120/4.5..27 1.13/10	N/lb. Nm/lb.in.
<b>Weight</b>	PLUS247 TO-264	6 10	g g

TO-264 (IXFK)



PLUS247 (IXFX)

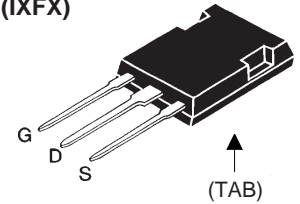

G = Gate      D = Drain  
S = Source      TAB = Drain

**Features**

- International Standard Packages
- Fast Intrinsic Diode
- Avalanche Rated
- Low  $R_{DS(ON)}$  and  $Q_G$
- Low Package Inductance

**Advantages**

- Easy to Mount
- Space Savings
- High Power Density

**Applications**

- DC-DC Converters
- Battery Chargers
- Switched-Mode and Resonant-Mode Power Supplies
- DC Choppers
- AC and DC Motor Drives
- Uninterrupted Power Supplies
- High Speed Power Switching Applications

Symbol	Test Conditions ( $T_J = 25^\circ C$ , Unless Otherwise Specified)	Characteristic Values		
		Min.	Typ.	Max.
$BV_{DSS}$	$V_{GS} = 0V$ , $I_D = 250\mu A$	500		V
$V_{GS(th)}$	$V_{DS} = V_{GS}$ , $I_D = 8mA$	3.0		5.5 V
$I_{GSS}$	$V_{GS} = \pm 30V$ , $V_{DS} = 0V$			$\pm 200$ nA
$I_{DSS}$	$V_{DS} = V_{DSS}$ , $V_{GS} = 0V$ $T_J = 125^\circ C$			25 $\mu A$ 1 mA
$R_{DS(on)}$	$V_{GS} = 10V$ , $I_D = 0.5 \cdot I_{D25}$ , Note 1			85 m $\Omega$

Symbol	Test Conditions ( $T_J = 25^\circ\text{C}$ , Unless Otherwise Specified)	Characteristic Values		
		Min.	Typ.	Max.
$g_{fs}$	$V_{DS} = 20\text{V}, I_D = 0.5 \cdot I_{D25}$ , Note 1	30	50	S
$C_{iss}$	$V_{GS} = 0\text{V}, V_{DS} = 25\text{V}, f = 1\text{MHz}$		9700	nF
$C_{oss}$			970	pF
$C_{rss}$			30	pF
$t_{d(on)}$	<b>Resistive Switching Times</b> $V_{GS} = 10\text{V}, V_{DS} = 0.5 \cdot V_{DSS}, I_D = 0.5 \cdot I_{D25}$ $R_G = 2\Omega$ (External)		30	ns
$t_r$			25	ns
$t_{d(off)}$			85	ns
$t_f$			22	ns
$Q_{g(on)}$	$V_{GS} = 10\text{V}, V_{DS} = 0.5 \cdot V_{DSS}, I_D = 0.5 \cdot I_{D25}$		150	nC
$Q_{gs}$			50	nC
$Q_{gd}$			50	nC
$R_{thJC}$				0.15 $^\circ\text{C/W}$
$R_{thCS}$		0.15		$^\circ\text{C/W}$

### Source-Drain Diode

Symbol	Test Conditions ( $T_J = 25^\circ\text{C}$ , Unless Otherwise Specified)	Characteristic Values		
		Min.	Typ.	Max.
$I_s$	$V_{GS} = 0\text{V}$			64 A
$I_{SM}$	Repetitive, Pulse Width Limited by $T_{JM}$			250 A
$V_{SD}$	$I_F = 64\text{A}, V_{GS} = 0\text{V}$ , Note 1			1.5 V
$t_{rr}$	$I_F = 25\text{A}, -di/dt = 100\text{A}/\mu\text{s}$ $V_R = 100\text{V}, V_{GS} = 0\text{V}$			200 nS
$Q_{RM}$			0.6	$\mu\text{C}$
$I_{RM}$			6.0	A

Note 1: Pulse Test,  $t \leq 300\mu\text{s}$ ; Duty Cycle,  $d \leq 2\%$ .

### TO-264 (IXFK) Outline

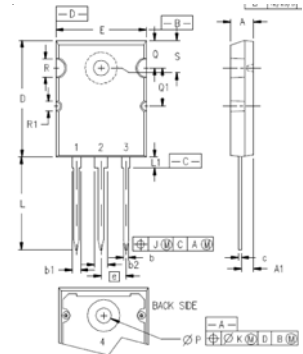

- 1 - GATE  
2, 4 - DRAIN (COLLECTOR)  
3 - SOURCE (EMITTER)

SYM	INCHES		MILLIMETERS	
	MIN	MAX	MIN	MAX
A	.185	.209	4.70	5.31
A1	.102	.118	2.59	3.00
b	.037	.055	0.94	1.40
b1	.087	.102	2.21	2.59
b2	.110	.126	2.79	3.20
c	.017	.029	0.43	0.74
D	1.007	1.047	25.58	26.59
E	.760	.799	19.30	20.29
e	.215BSC		5.46 BSC	
J	.000	.010	0.00	0.25
K	.000	.010	0.00	0.25
L	.779	.842	19.79	21.39
L1	.087	.102	2.21	2.59
ØP	.122	.138	3.10	3.51
Q	.240	.256	6.10	6.50
Q1	.330	.346	8.38	8.79
ØR	.155	.187	3.94	4.75
ØR1	.085	.093	2.16	2.36
S	.243	.253	6.17	6.43

### PLUS 247™ (IXFX) Outline

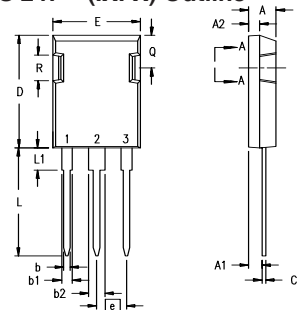

- Terminals: 1 - Gate  
2 - Drain (Collector)  
3 - Source (Emitter)  
4 - Drain (Collector)

Dim.	Millimeter		Inches	
	Min.	Max.	Min.	Max.
A	4.83	5.21	.190	.205
A <sub>1</sub>	2.29	2.54	.090	.100
A <sub>2</sub>	1.91	2.16	.075	.085
b	1.14	1.40	.045	.055
b <sub>1</sub>	1.91	2.13	.075	.084
b <sub>2</sub>	2.92	3.12	.115	.123
C	0.61	0.80	.024	.031
D	20.80	21.34	.819	.840
E	15.75	16.13	.620	.635
e	5.45 BSC		.215 BSC	
L	19.81	20.32	.780	.800
L1	3.81	4.32	.150	.170
Q	5.59	6.20	.220	0.244
R	4.32	4.83	.170	.190

IXYS Reserves the Right to Change Limits, Test Conditions, and Dimensions.

IXYS MOSFETs and IGBTs are covered by one or more of the following U.S. patents:	4,835,592	4,931,844	5,049,961	5,237,481	6,162,665	6,404,065 B1	6,683,344	6,727,585	7,005,734 B2	7,157,338B2
	4,850,072	5,017,508	5,063,307	5,381,025	6,259,123 B1	6,534,343	6,710,405 B2	6,759,692	7,063,975 B2	
	4,881,106	5,034,796	5,187,117	5,486,715	6,306,728 B1	6,583,505	6,710,463	6,771,478 B2	7,071,537	

**Fig. 1. Output Characteristics**  
**@ 25°C**

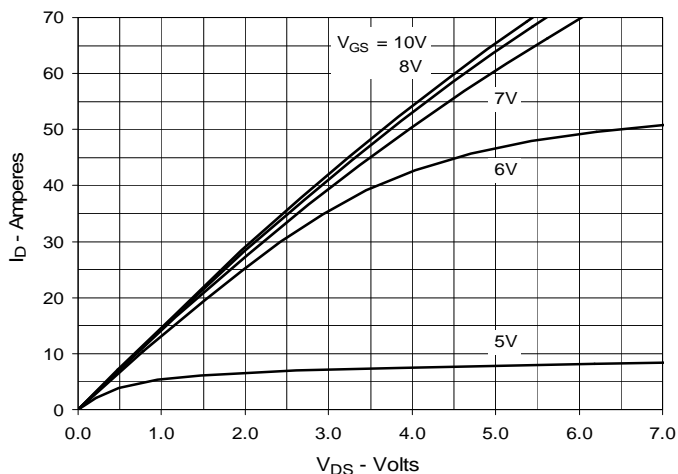

**Fig. 2. Extended Output Characteristics**  
**@ 25°C**

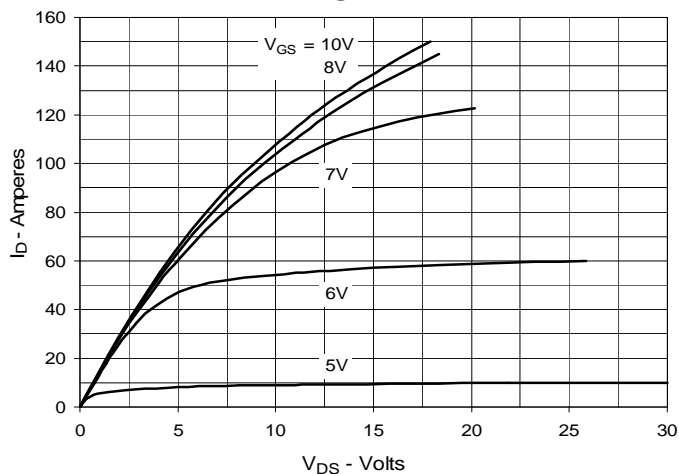

**Fig. 3. Output Characteristics**  
**@ 125°C**

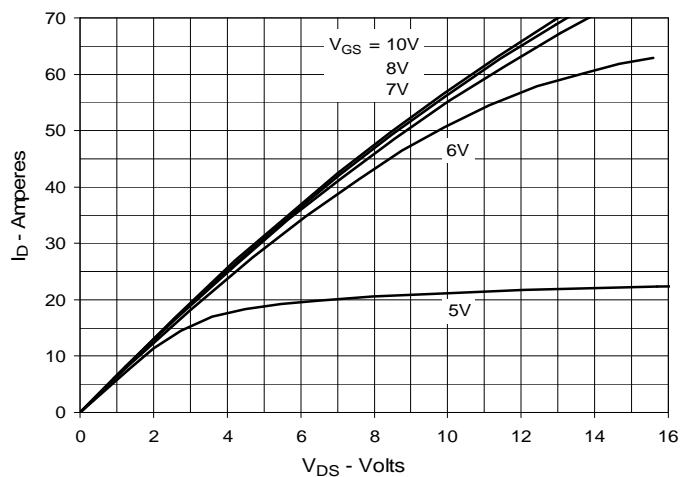

**Fig. 4.  $R_{DS(on)}$  Normalized to  $I_D = 32\text{A}$  Value**  
**vs. Junction Temperature**

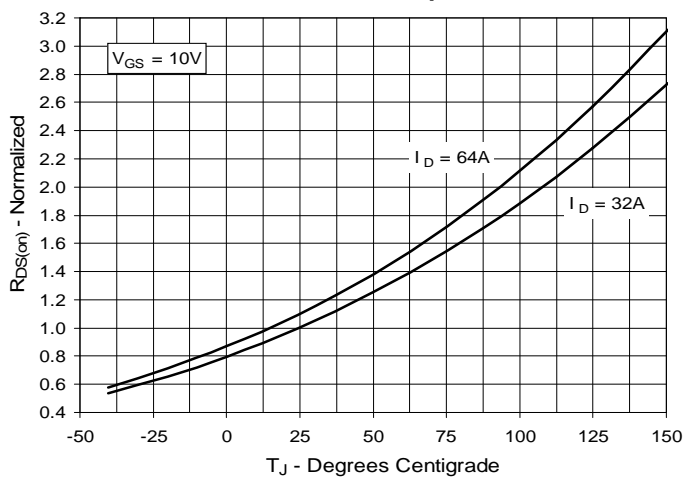

**Fig. 5.  $R_{DS(on)}$  Normalized to  $I_D = 32\text{A}$  Value**  
**vs. Drain Current**

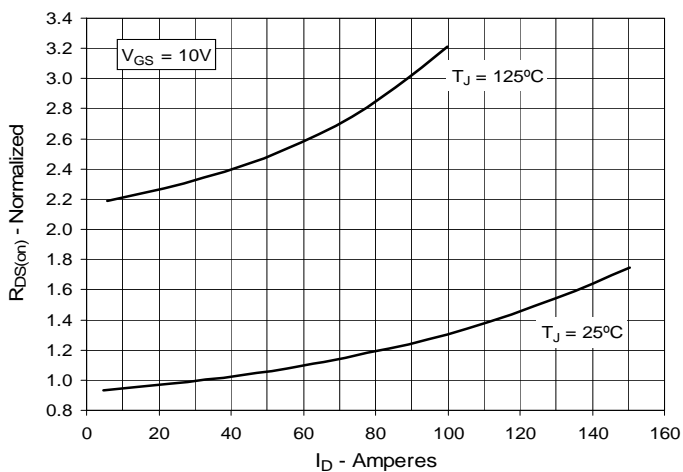

**Fig. 6. Maximum Drain Current vs.**  
**Case Temperature**

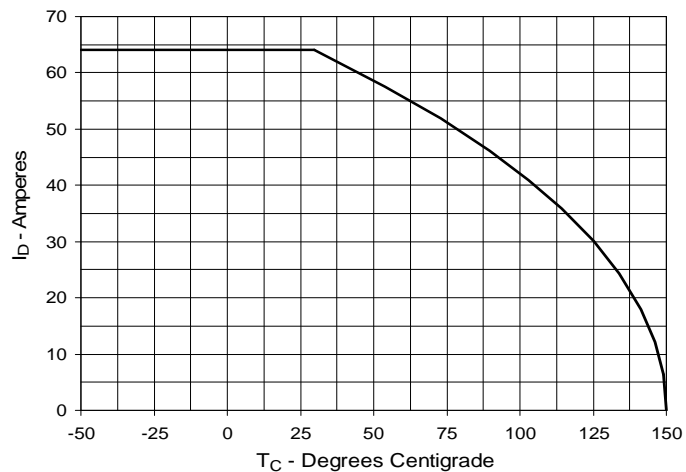

**Fig. 7. Input Admittance**

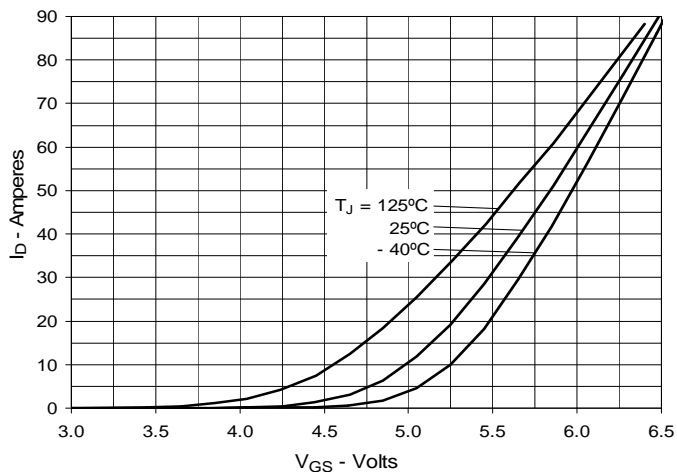

**Fig. 8. Transconductance**

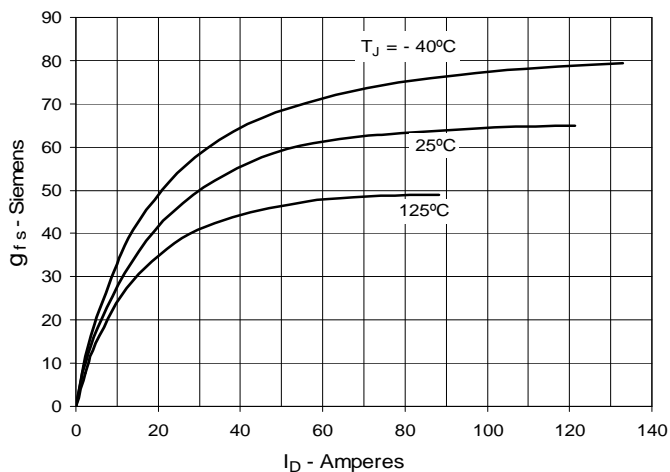

**Fig. 9. Forward Voltage Drop of Intrinsic Diode**

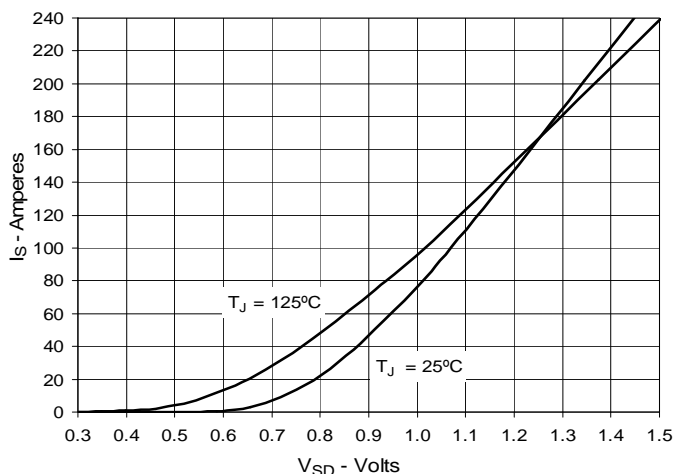

**Fig. 10. Gate Charge**

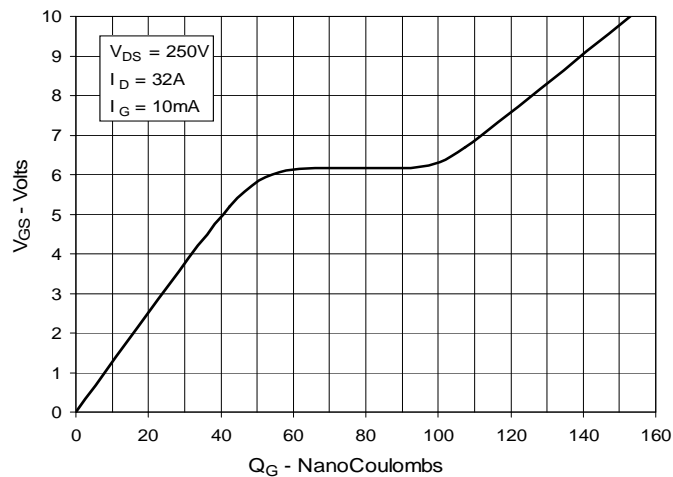

**Fig. 11. Capacitance**

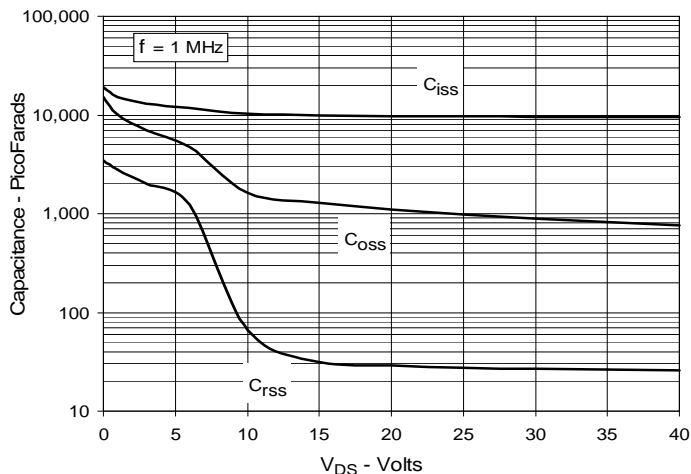

**Fig. 12. Maximum Transient Thermal Impedance**

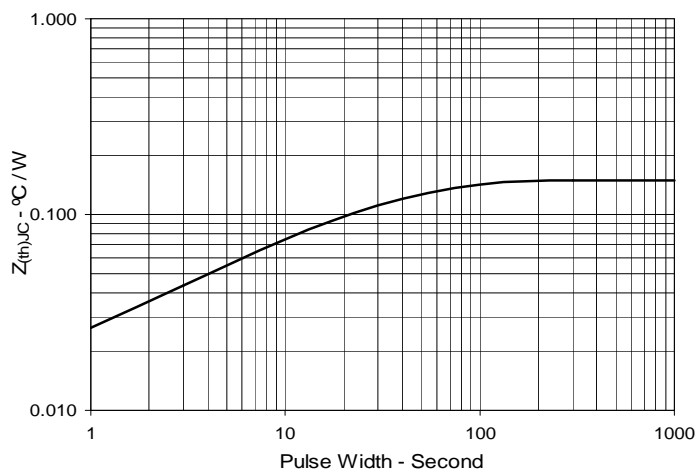



---

Disclaimer Notice - Information furnished is believed to be accurate and reliable. However, users should independently evaluate the suitability of and test each product selected for their own applications. Littelfuse products are not designed for, and may not be used in, all applications. Read complete Disclaimer Notice at [www.littelfuse.com/disclaimer-electronics](http://www.littelfuse.com/disclaimer-electronics).