

MM IN  
 8.48 .334  
 8.55 .337  
 11.43 .45  
 6.35 .25  
 34.92 1.375  
 41.27 1.625

METRIC

75228-03

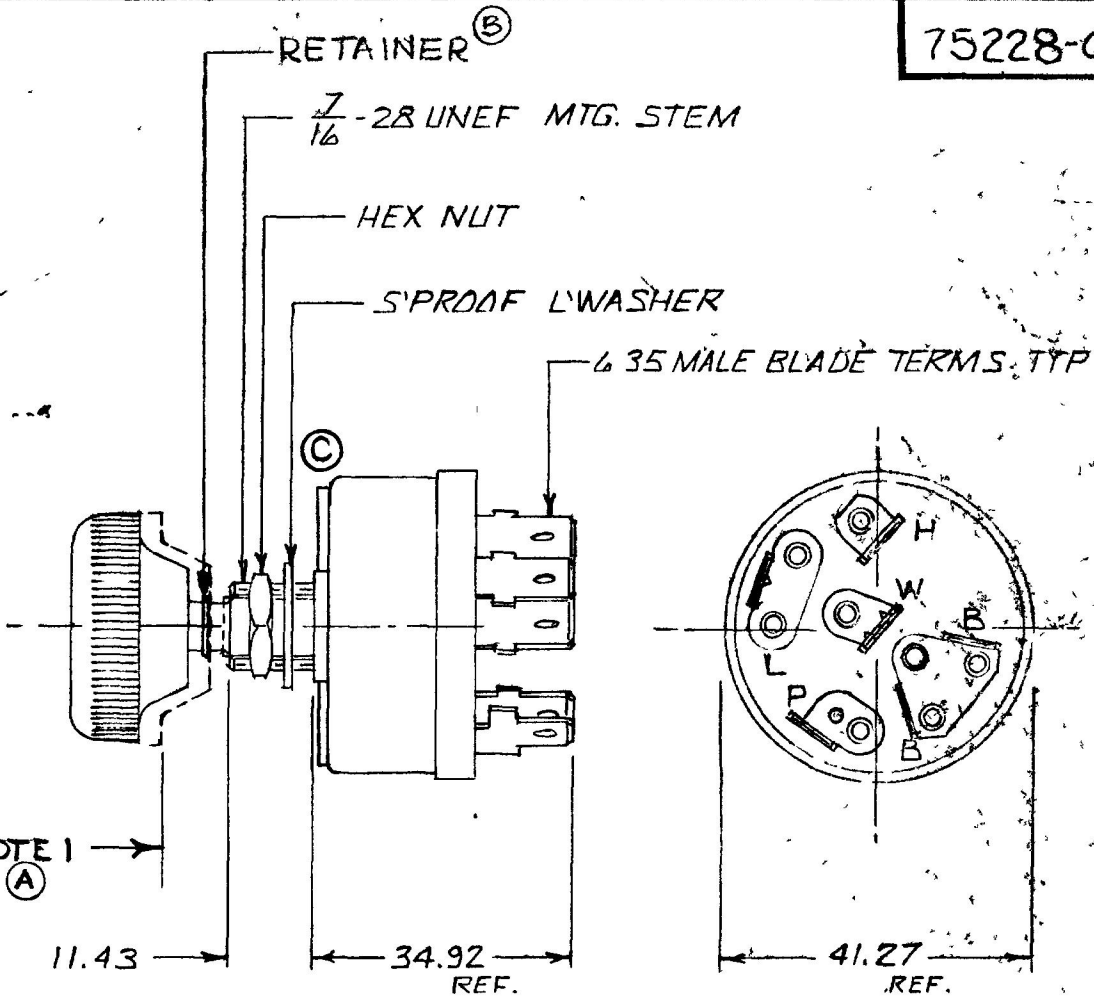
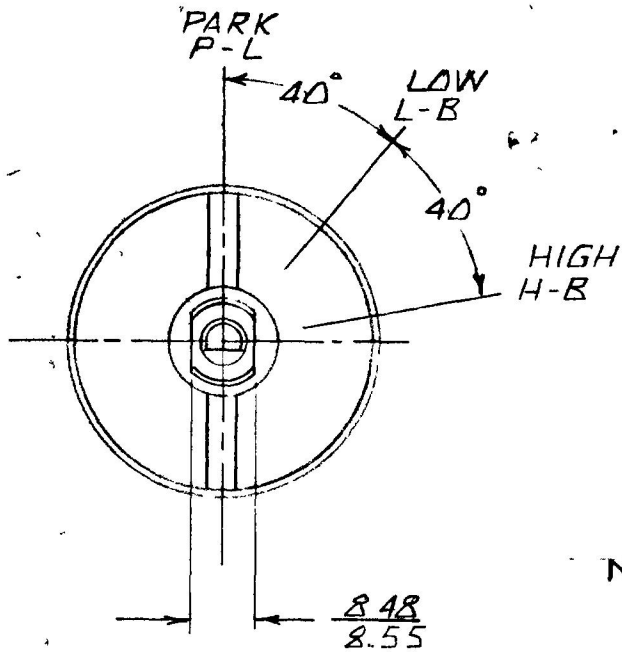

NOTE 1 (A)

NOTE:  
 1. PUSH KNOB TO ACTIVATE WASHER CIRCUIT PARK, LOW, HIGH POSITIONS  
 2. ALL STEEL PARTS PLATED

12VOLTS @ 10AMPS

FRONT VIEW OF KNOB

DO NOT SCALE

LET	WAS	DATE	BY	LET	WAS	DATE	BY	MATERIAL	DRAWN	CHECKED	APPRV D	SCALE	BASIC 02 WITH KNOB	DATE DRAWN
									EA	RFB		1=1		3-25-83
				C	ECN 24372	6/7/90	BL	FINISH	 Cole Hersee Co. <small>20 OLD COLONY AVENUE SOUTH BOSTON MA USA 02127</small>					DATE BLUEPRINT
				B	SEN 23512	12-12-86	ZU							
				A	22545	10-5-84	AK	TOLERANCES	3 POS ROTARY SW					75228-03
					ISSUED	1/27/83	REF	DECIMAL ± .010 METRIC ± .25						

CH-188(4-78)