

COLE-HERSEE CO. N.P.M. 2-11-74

MP 60340 EX16855

55071

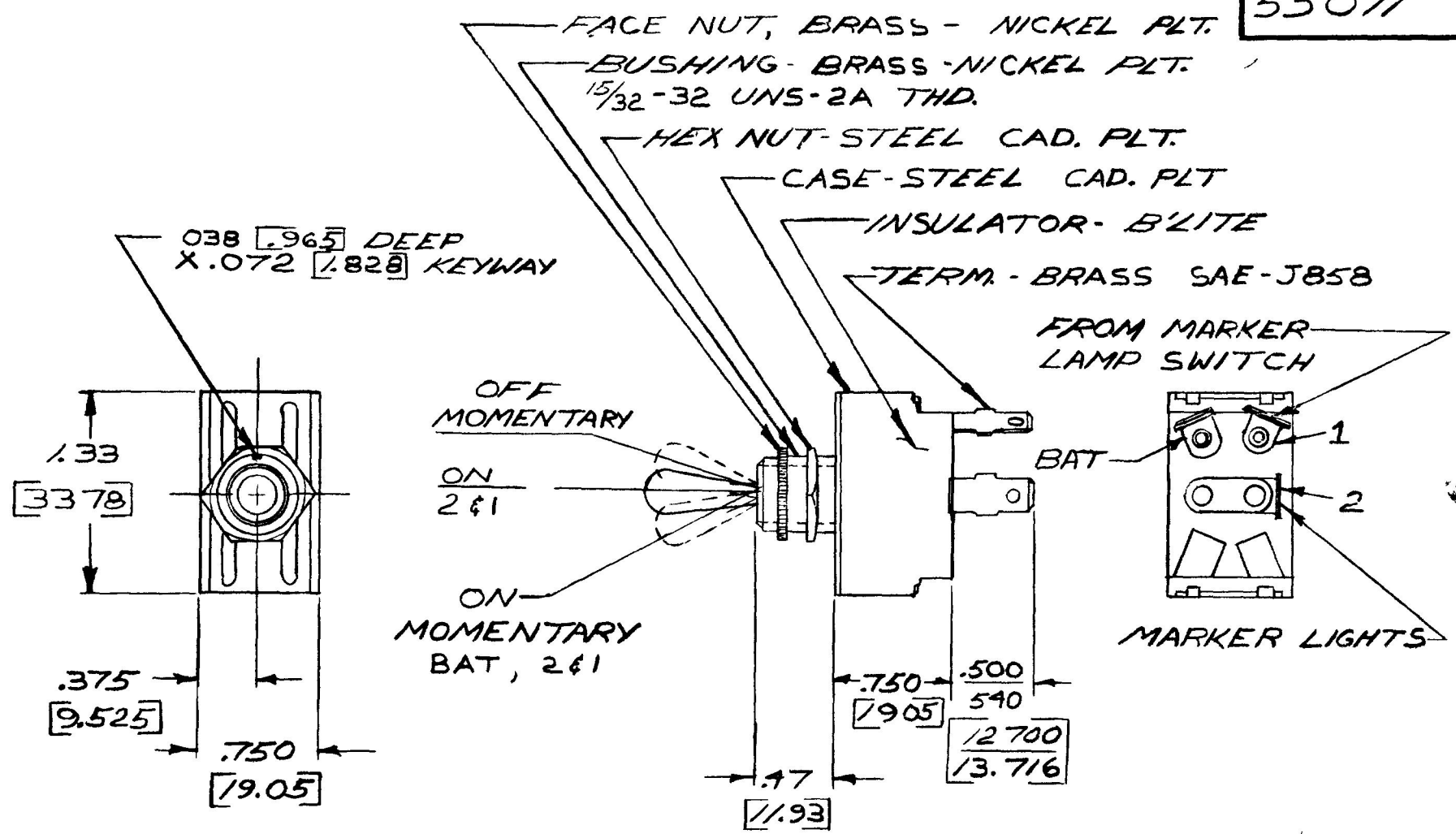

NOTE:
 Ⓐ SILVER CONTACT SURFACES

TERM.	DESCRIPT.
1	MARKER LAMP SW.
2	MARKER LAMPS

25 AMPS @ 12 VDC

DO NOT SCALE

ET	WAS	DATE	BY	LET	WAS	DATE	BY	MATERIAL	DRAWN	CHECKED	APPRV'D	SCALE	DATE DRAWN
								#	E	R		FULL	2-14-74
								FINISH	COLE-HERSEE COMPANY				DATE BLUEPRINT
								#	BOSTON, MASS 02127, USA				
				A	ADD NCTR / 25432	9/15/13	TJH	TOLERANCES	MARKER LAMP				55071
					ISSUED	2-14-74	RY	FRACTIONAL ±	TOGGLE SWITCH				
								DECIMAL ±.01					