

5KP Series

Axial Leaded – 5 kW

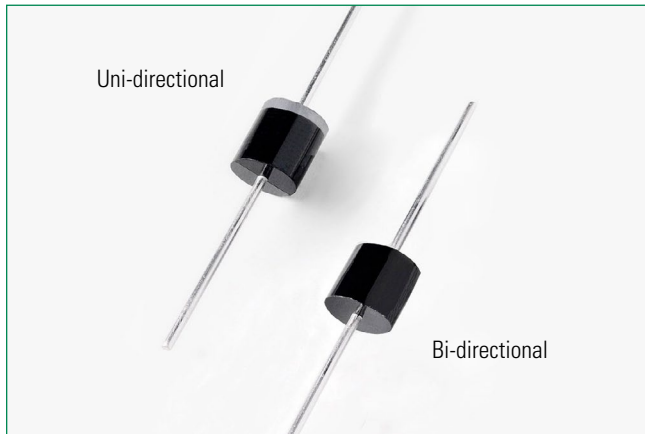

Additional Information



Resources



Accessories



Samples

Agency Approvals

Agency	Agency File Number
	E230531

Maximum Ratings and Thermal Characteristics ($T_A=25^\circ\text{C}$ unless otherwise noted)

Parameter	Symbol	Value	Unit
Peak Pulse Power Dissipation by 10/1000 μs Test Waveform (Fig.2)(Note 1)	P_{PPM}	5	kW
Steady State Power Dissipation on Infinite Heat Sink at $T_L=75^\circ\text{C}$	P_D	8.0	W
Peak Forward Surge Current, 8.3ms Single Half Sine Wave Unidirectional Only (Note 2)	I_{FSM}	400	A
Maximum Instantaneous Forward Voltage at 100A for Unidirectional Only (Note 3)	V_F	3.5/5.0	V
Operating Junction and Storage Temperature Range	T_J, T_{STG}	-55 to 175	$^\circ\text{C}$
Typical Thermal Resistance Junction to Lead	$R_{\theta JL}$	8.0	$^\circ\text{C/W}$
Typical Thermal Resistance Junction to Ambient	$R_{\theta JA}$	40	$^\circ\text{C/W}$

Notes:

- Non-repetitive current pulse, per Fig. 4 and derated above T_J (initial) $=25^\circ\text{C}$ per Fig. 3.
- Measured on 8.3ms single half sine wave or equivalent square wave, duty cycle=4 per minute maximum.
- $V_F < 3.5\text{V}$ for single die parts and $V_F < 5.0\text{V}$ for stacked-die parts.



Description

The 5KP Series is designed specifically to protect sensitive electronic equipment from voltage transients induced by lightning and other transient voltage events.

Features and Benefits

- 5 kW peak pulse capability at 10/1000 μs waveform, repetition rate (duty cycles):0.01%
- Glass passivated chip junction in P600 package
- Fast response time: typically less than 1.0ps from 0 Volts to BV min
- Typical failure mode is short from over-specified voltage or current
- Whisker test is conducted based on JEDEC JESD201A per its table 4a and 4c pass Class 1 and 2.
- IEC 61000-4-2 ESD 30kV(Air), 30kV (Contact)
- Low dynamic resistance
- Typical IR less than 2 μA when VBR min>12V
- VBR @ $T_J = VBR@25^\circ\text{C} \times (1 + \alpha T \times (T_J - 25))$ (α :Temperature Coefficient, typical value is 0.1%)
- UL Recognized compound meeting flammability rating V-0
- Halogen free and RoHS compliant
- Pb-free E3 indicates that 2nd level interconnect is Pb-free and the terminal finish material is tin(Sn) (IPC/JEDEC J-STD-609A.01)
- Recognized to UL 497B as an Isolated Loop Circuit Protector

Applications

TVS components are ideal for the protection of I/O interfaces, VCC bus and other vulnerable circuits used in telecom, computer, industrial and consumer electronic applications.

Functional Diagram

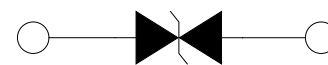

Bi-directional



Uni-directional

5KP Series

Axial Leaded – 5 kW

Electrical Characteristics ($T_A=25^\circ\text{C}$ unless otherwise noted)

Part Number (Uni)	Part Number (Bi)	Reverse Stand off Voltage V_R (Volts)	Breakdown Voltage V_{BR} (Volts) @ I_T		Test Current I_T (mA)	Maximum Clamping Voltage $V_C @ I_{PP}$ (V)	Maximum Peak Pulse Current I_{PP} (A)	Maximum Reverse Leakage $I_R @ V_R$ (μA)	Agency Approval
			Min	Max					
5KP5.0A	5KP5.0CA	5.0	6.40	7.00	50	9.2	554.3	5000	X
5KP6.0A	5KP6.0CA	6.0	6.67	7.37	50	10.3	495.1	5000	X
5KP6.5A	5KP6.5CA	6.5	7.22	7.98	50	11.2	455.4	2000	X
5KP7.0A	5KP7.0CA	7.0	7.78	8.60	50	12.0	425.0	1000	X
5KP7.5A	5KP7.5CA	7.5	8.33	9.21	5	12.9	395.3	250	X
5KP8.0A	5KP8.0CA	8.0	8.89	9.83	5	13.6	375.0	150	X
5KP8.5A	5KP8.5CA	8.5	9.44	10.40	5	14.4	354.2	50	X
5KP9.0A	5KP9.0CA	9.0	10.00	11.10	5	15.4	331.2	20	X
5KP10A	5KP10CA	10.0	11.10	12.30	5	17.0	300.0	15	X
5KP11A	5KP11CA	11.0	12.20	13.50	5	18.2	280.2	2	X
5KP12A	5KP12CA	12.0	13.30	14.70	5	19.9	256.3	2	X
5KP13A	5KP13CA	13.0	14.40	15.90	5	21.5	237.2	2	X
5KP14A	5KP14CA	14.0	15.60	17.20	5	23.2	219.8	2	X
5KP15A	5KP15CA	15.0	16.70	18.50	5	24.4	209.0	2	X
5KP16A	5KP16CA	16.0	17.80	19.70	5	26.0	196.2	2	X
5KP17A	5KP17CA	17.0	18.90	20.90	5	27.6	184.8	2	X
5KP18A	5KP18CA	18.0	20.00	22.10	5	29.2	174.7	2	X
5KP20A	5KP20CA	20.0	22.20	24.50	5	32.4	157.4	2	X
5KP22A	5KP22CA	22.0	24.00	26.90	5	35.5	143.7	2	X
5KP24A	5KP24CA	24.0	26.70	29.50	5	38.9	131.1	2	X
5KP26A	5KP26CA	26.0	28.90	31.90	5	42.1	121.1	2	X
5KP28A	5KP28CA	28.0	31.10	34.40	5	45.4	112.3	2	X
5KP30A	5KP30CA	30.0	33.30	36.80	5	48.4	105.4	2	X
5KP33A	5KP33CA	33.0	36.70	40.60	5	53.3	95.7	2	X
5KP36A	5KP36CA	36.0	40.00	44.20	5	58.1	87.8	2	X
5KP40A	5KP40CA	40.0	44.40	49.10	5	64.5	79.1	2	X
5KP43A	5KP43CA	43.0	47.80	52.80	5	69.4	73.5	2	X
5KP45A	5KP45CA	45.0	50.00	55.30	5	72.7	70.2	2	X
5KP48A	5KP48CA	48.0	53.30	58.90	5	77.4	65.9	2	X
5KP51A	5KP51CA	51.0	56.70	62.70	5	82.4	61.9	2	X
5KP54A	5KP54CA	54.0	60.00	66.30	5	87.1	58.6	2	X
5KP58A	5KP58CA	58.0	64.40	71.20	5	93.6	54.5	2	X
5KP60A	5KP60CA	60.0	66.70	73.70	5	96.8	52.7	2	X
5KP64A	5KP64CA	64.0	71.10	78.60	5	103.0	49.5	2	X
5KP70A	5KP70CA	70.0	77.80	86.00	5	113.0	45.1	2	X
5KP75A	5KP75CA	75.0	83.30	92.10	5	121.0	42.1	2	X
5KP78A	5KP78CA	78.0	86.70	95.80	5	126.0	40.5	2	X
5KP85A	5KP85CA	85.0	94.40	104.00	5	137.0	37.2	2	X
5KP90A	5KP90CA	90.0	100.00	111.00	5	146.0	34.9	2	X
5KP100A	5KP100CA	100.0	110.00	123.00	5	162.0	31.5	2	X
5KP110A	5KP110CA	110.0	122.00	135.00	5	177.0	28.8	2	X
5KP120A	5KP120CA	120.0	133.00	147.00	5	193.0	26.4	2	X
5KP130A	5KP130CA	130.0	144.00	159.00	5	209.0	24.4	2	X
5KP150A	5KP150CA	150.0	167.00	185.00	5	243.0	21.0	2	X
5KP160A	5KP160CA	160.0	178.00	197.00	5	259.0	19.7	2	X
5KP170A	5KP170CA	170.0	189.00	209.00	5	275.0	18.5	2	X
5KP180A	5KP180CA	180.0	200.00	221.00	5	292.0	17.5	2	X
5KP190A	5KP190CA	190.0	211.00	233.00	5	310.0	16.5	2	X
5KP200A	5KP200CA	200.0	222.00	246.00	5	329.2	15.5	2	X
5KP210A	5KP210CA	210.0	233.00	258.00	5	349.5	14.6	2	X
5KP220A	5KP220CA	220.0	244.00	270.00	5	371.1	13.7	2	X
5KP250A	5KP250CA	250.0	277.00	306.00	5	425.0	12.0	2	X
5KP300A	5KP300CA	300.0	335.00	373.00	5	503.0	10.2	2	X
5KP350A	5KP350CA	350.0	391.00	433.00	5	585.0	8.7	2	X

For bidirectional type having V_R of 10 volts and less, the I_R limit is double.

For parts without A, the V_{BR} is $\pm 10\%$ and V_C is 5% higher than with A parts, the parts without A are currently available, but not recommended for new designs. The parts with A are preferred.

5KP Series

Axial Leaded – 5 kW

I-V Curve Characteristics

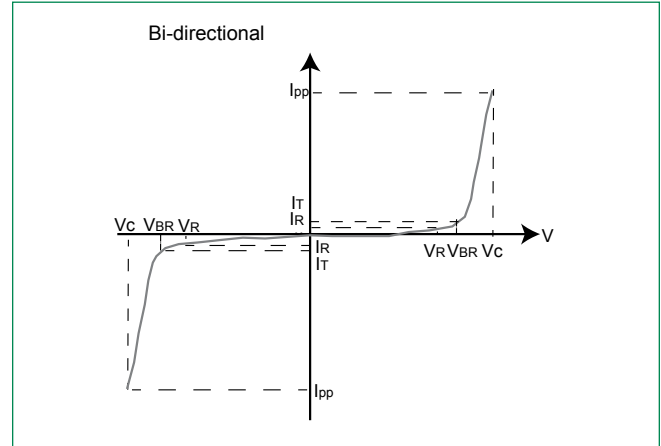
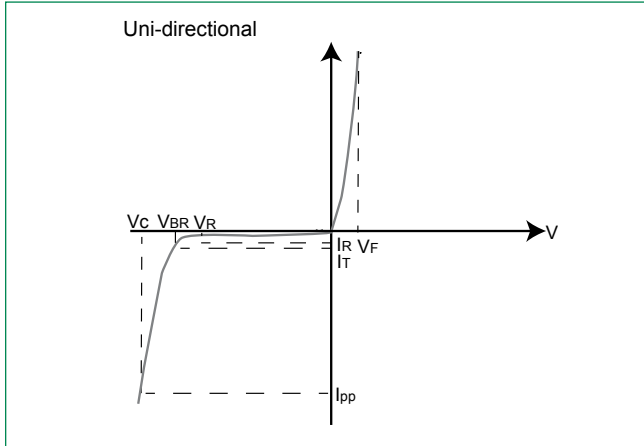

- P_{PPM}** Peak Pulse Power Dissipation – Max power dissipation
- V_R** Stand-off Voltage – Maximum voltage that can be applied to the TVS without operation
- V_{BR}** Breakdown Voltage – Maximum voltage that flows though the TVS at a specified test current (I_T)
- V_C** Clamping Voltage – Peak voltage measured across the TVS at a specified I_{ppm} (peak impulse current)
- I_R** Reverse Leakage Current – Current measured at V_R
- V_F** Forward Voltage Drop for Uni-directional

Ratings and Characteristic Curves ($T_A=25^\circ\text{C}$ unless otherwise noted)

Figure 1 - TVS Transients Clamping Waveform

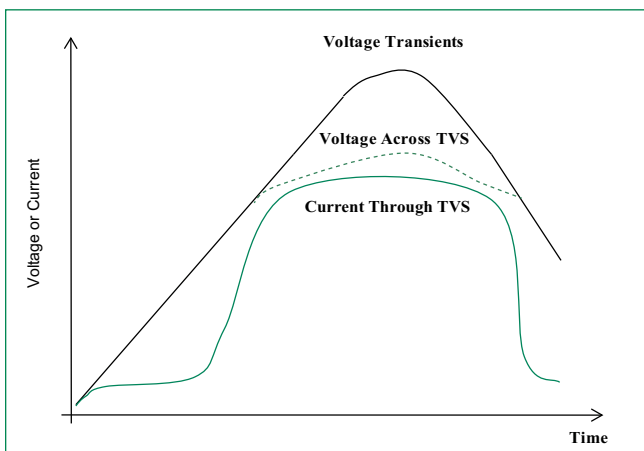
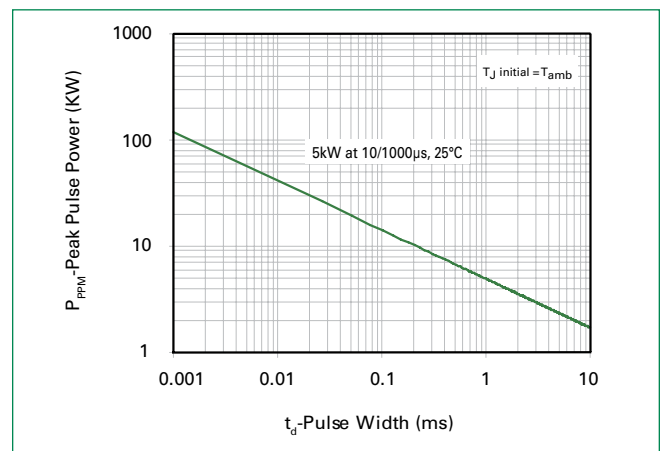

Figure 2 - Peak Pulse Power Rating Curve



5KP Series

Axial Leaded – 5 kW

Ratings and Characteristic Curves ($T_A=25^\circ\text{C}$ unless otherwise noted) (Continued)

Figure 3 - Peak Pulse Power Derating Curve

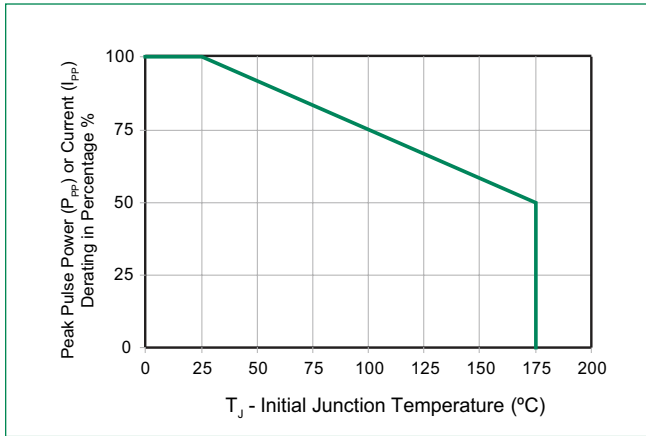

Figure 4 - Pulse Waveform

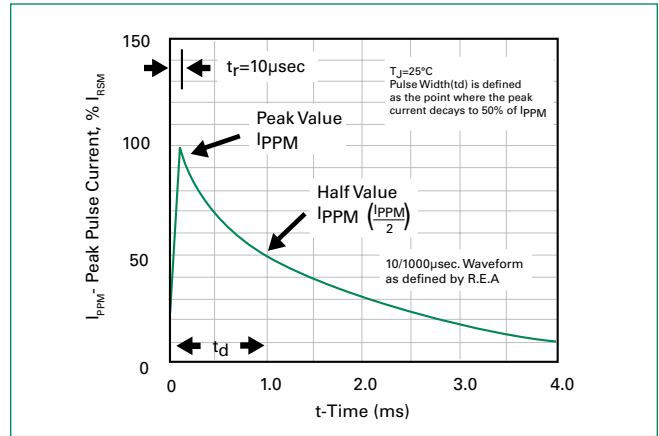

Figure 5 - Typical Junction Capacitance

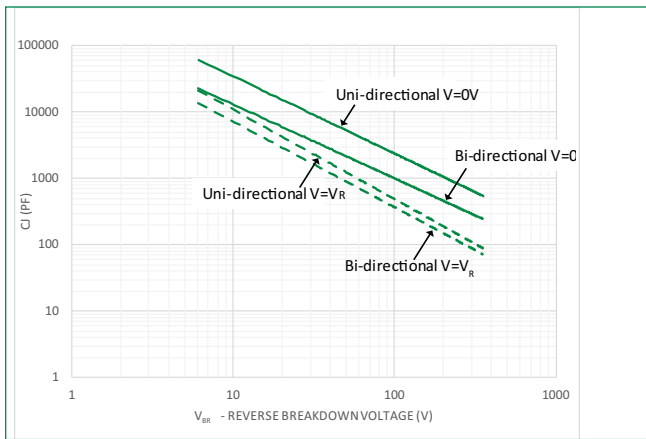

Figure 6 - Typical Transient Thermal Impedance

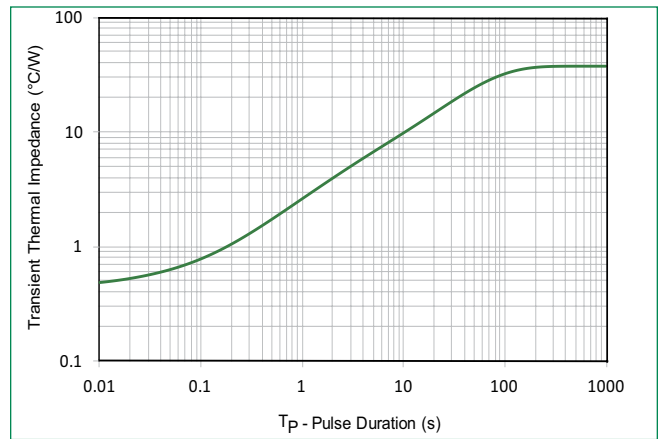

Figure 7 - Maximum Non-Repetitive Peak Forward Surge Current Uni-Directional Only

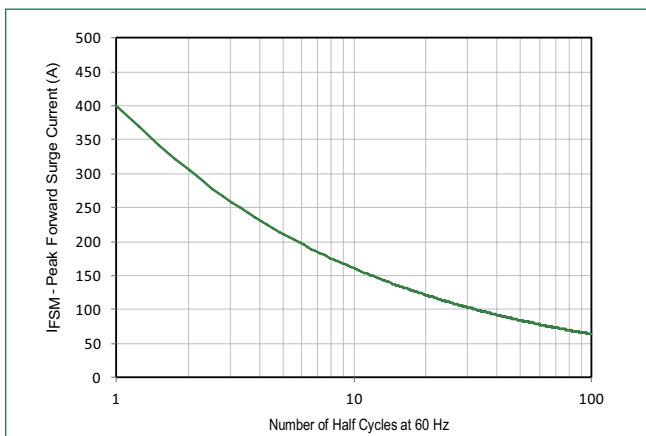
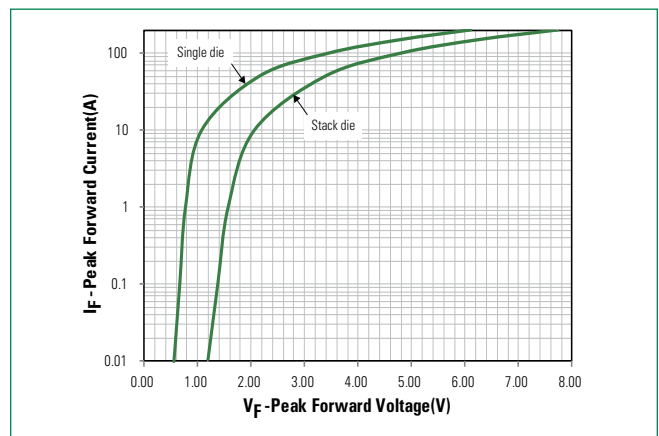

Figure 8 - Peak Forward Voltage Drop vs Peak Forward Current (Typical Values)



5KP Series

Axial Leaded – 5 kW

Soldering Parameters

Reflow Condition		Lead-free assembly
Pre Heat	- Temperature Min ($T_{s(min)}$)	150°C
	- Temperature Max ($T_{s(max)}$)	200°C
	- Time (min to max) (t_s)	60 – 120 secs
Average ramp up rate (Liquidus Temp (T_A) to peak)		3°C/second max
$T_{s(max)}$ to T_A - Ramp-up Rate		3°C/second max
Reflow	- Temperature (T_A) (Liquidus)	217°C
	- Time (min to max) (t_s)	60 – 150 seconds
Peak Temperature (T_p)		260 ^{+0/-5} °C
Time within 5°C of actual peak Temperature (t_p)		30 seconds
Ramp-down Rate		6°C/second max
Time 25°C to peak Temperature (T_p)		8 minutes Max.
Do not exceed		260°C

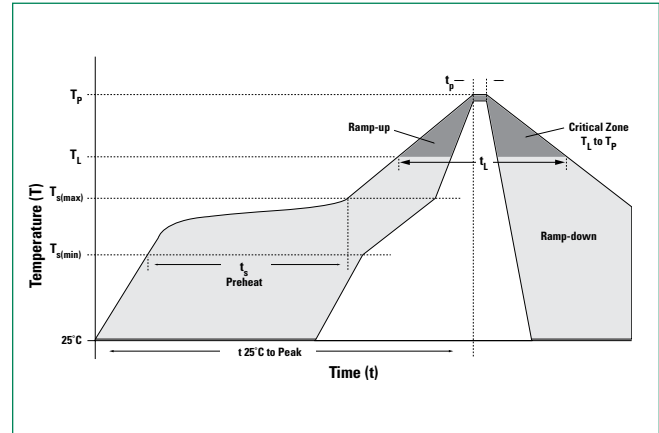

Flow/Wave Soldering (Solder Dipping)

Peak Temperature :	265°C
Dipping Time :	10 seconds
Soldering :	1 time

Physical Specifications

Weight	0.07oz., 2.1g
Case	P600 molded plastic body over passivated junction.
Polarity	Color band denotes the cathode except Bipolar.
Terminal	Matte Tin axial leads, solderable per JESD22-B102.

Environmental Specifications

High Temp. Storage	JESD22-A103
HTRB	JESD22-A108
Temperature Cycling	JESD22-A104
H3TRB	JESD22-A101

Dimensions

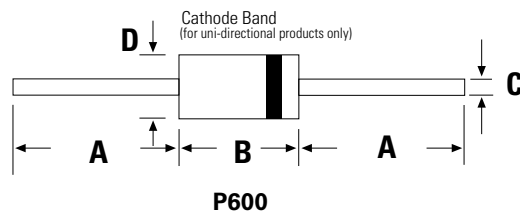

Dimensions	Inches		Millimeters	
	Min	Max	Min	Max
A	1.000	-	25.40	-
B	0.340	0.360	8.60	9.10
C	0.048	0.054	1.22	1.36
D	0.340	0.360	8.60	9.10

5KP Series

Axial Leaded – 5 kW

Part Numbering System

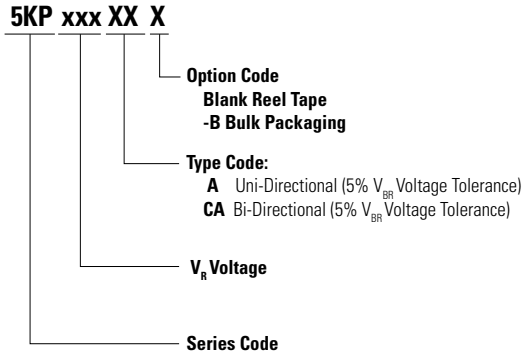

Part Marking System

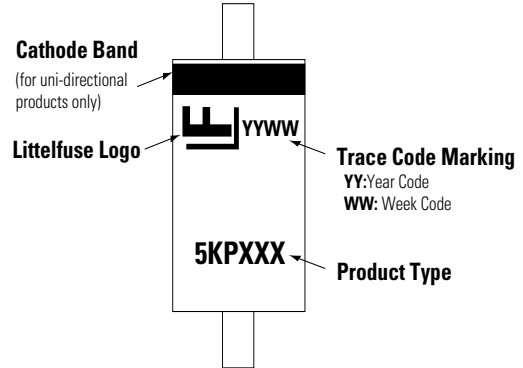

Packing Options

Part Number	Component Package	Quantity	Packaging Option	Packaging Specification
5KPxxxXX	P600	800	Tape & Reel	EIA STD RS-296
5KPxxxXX-B	P600	100	BULK	Littelfuse Spec.

Tape and Reel Specification

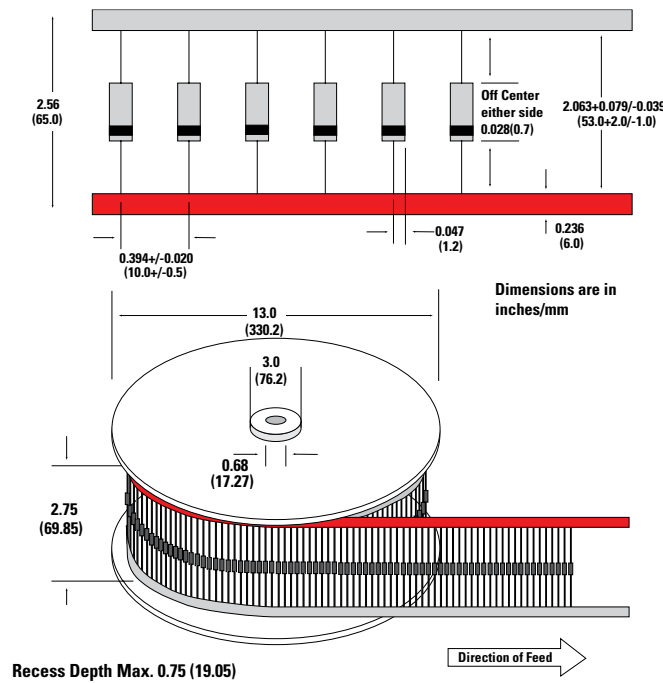

Disclaimer Notice - Information furnished is believed to be accurate and reliable. However, users should independently evaluate the suitability of and test each product selected for their own applications. Littelfuse products are not designed for, and may not be used in, all applications. Read complete Disclaimer Notice at www.littelfuse.com/disclaimer-electronics.