

Battrax® Series Positive/Negative - Modified DO-214



Description

The Battrax® series offers programmable SIDACtor® overvoltage protection devices for SLIC applications. This series is offered in a negative Battrax version and a positive Battrax version. The B1xx0C_ is for a $-V_{REF}$ supply and the B2050C_ is for a $+V_{REF}$ supply. Designed using an SCR and a gate diode, the B1xx0C_ Battrax begins to conduct at $| -V_{REF} | + | -1.2 V |$ while the B2050C_ Battrax begins to conduct at $| +V_{REF} | + | 1.2 V |$.

Features and Benefits

- Low voltage overshoot
- Low on-state voltage
- Does not degrade surge capability after multiple surge events within limit.
- Fails short circuit when surged in excess of ratings
- Robust surge current ratings
- Gate triggered tracking devices
- Pb-free E3 means 2nd level interconnect is Pb-free and the terminal finish material is tin(Sn) (IPC/JEDEC J-STD-609A.01)

Agency Approvals

| Agency | Agency File Number |
|--------|--------------------|
| | E133083 |

Pinout Designation

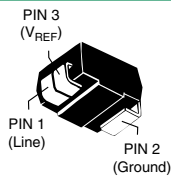

Schematic Symbol

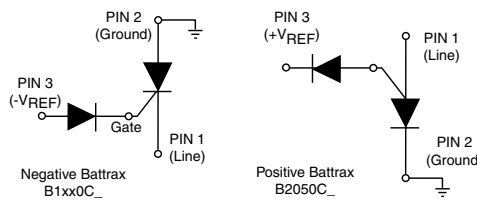

Applicable Global Standards

- TIA-968-A
- TIA-968-B
- ITU K.20/21 Enhanced Level*
- ITU K.20/21 Basic Level
- GR 1089 Inter-building*
- GR 1089 Intra-building
- IEC 61000-4-5
- YD/T 1082
- YD/T 993
- YD/T 950

*A-rated parts require series resistance

Electrical Characteristics

| Part Number | Marking | V_{DRM} | V_S | I_H | I_S | I_T | V_T | Capacitance* | |
|-------------|---------|------------------------|-----------------------|--------|--------|-------|-------------------|--------------|-----|
| | | @ $I_{DRM}=5\mu A$ | @ $100V/\mu s$ | | | | @ $I_T=2.2 A$ mps | pF | |
| | | V min | V max | mA min | mA max | A max | V max | Min | Max |
| B1100CALRP | B10A | $-V_{REF} + -1.2V $ | $-V_{REF} + -10V $ | 100 | 100 | 2.2 | 4 | 30 | 200 |
| B1160CALRP | B16A | $-V_{REF} + -1.2V $ | $-V_{REF} + -10V $ | 160 | 100 | 2.2 | 4 | 30 | 200 |
| B1200CALRP | B12A | $-V_{REF} + -1.2V $ | $-V_{REF} + -10V $ | 200 | 100 | 2.2 | 4 | 30 | 200 |
| B2050CALRP | B25A | $+V_{REF} + 1.2V $ | $+V_{REF} + 10V $ | 5 | 50 | 2.2 | 4 | 20 | 200 |
| B1100CCLRP | B10C | $-V_{REF} + -1.2V $ | $-V_{REF} + -10V $ | 100 | 100 | 2.2 | 4 | 30 | 200 |
| B1160CCLRP | B16C | $-V_{REF} + -1.2V $ | $-V_{REF} + -10V $ | 160 | 100 | 2.2 | 4 | 30 | 200 |
| B1200CCLRP | B12C | $-V_{REF} + -1.2V $ | $-V_{REF} + -10V $ | 200 | 100 | 2.2 | 4 | 30 | 200 |
| B2050CCLRP | B25C | $+V_{REF} + 1.2V $ | $+V_{REF} + 10V $ | 5 | 50 | 2.2 | 4 | 20 | 200 |

Notes:
 - Absolute maximum ratings measured at $T_A = 25^\circ C$ (unless otherwise noted).
 - Devices are uni-directional
 - All electrical characteristics shown are defined from Tip (pin 1) to Ground (pin 2), and Ring (pin 1) to Ground (pin 2)

$-V_{REF}$ Max Value for the negative Battrax is -200 V.
 $-V_{REF}$ Max Value for the positive Battrax is 110 V.
 * Off-state capacitance (C_o) is measured across pins 1 & 2 at 1 MHz with a 2V bias.

Surge Ratings

| Series | I_{PP} | | | | | | | | | | I_{TSM} 50/60 Hz | di/dt | |
|--------|--|--|--|--|--|--|--|--|---|-------|-----------------------|-------|----------|
| | 0.2x310 ¹ 0.5x700 ² | 2x10 ¹ 2x10 ² | 8x20 ¹ 1.2x50 ² | 10x160 ¹ 10x160 ² | 10x560 ¹ 10x560 ² | 5x320 ¹ 9x720 ² | 10x360 ¹ 10x360 ² | 10x1000 ¹ 10x1000 ² | 5x310 ¹ 10x700 ² | A min | | | A/μs max |
| | A min | A min | A min | A min | A min | A min | A min | A min | A min | A min | | | A/μs max |
| A | 20 | 150 | 150 | 90 | 50 | 75 | 75 | 45 | 75 | 20 | 500 | | |
| C | 50 | 500 | 400 | 200 | 150 | 200 | 175 | 100 | 200 | 50 | 500 | | |

Notes:

- 1 Current waveform in μs
- 2 Voltage waveform in μs

- Peak pulse current rating (I_{PP}) is repetitive and guaranteed for the life of the product that remains in thermal equilibrium.
- I_{PP} ratings applicable over temperature range of -40°C to +85°C (I_{PP} rating assumes V_{REF} equals +/- 48V)
- The device must initially be in thermal equilibrium with -40°C ≤ T_J ≤ +150°C

Thermal Considerations

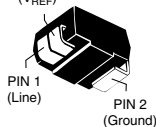
| Package | Symbol | Parameter | Value | Unit |
|---|-----------|---|-------------|------|
| Modified DO-214AA PIN 3 (V _{REF})  PIN 1 (Line) PIN 2 (Ground) | T_J | Operating Junction Temperature Range | -40 to +150 | °C |
| | T_S | Storage Temperature Range | -65 to +150 | °C |
| | $R_{θJA}$ | Thermal Resistance: Junction to Ambient | 85 | °C/W |

V-I Characteristics - Negative BattraX

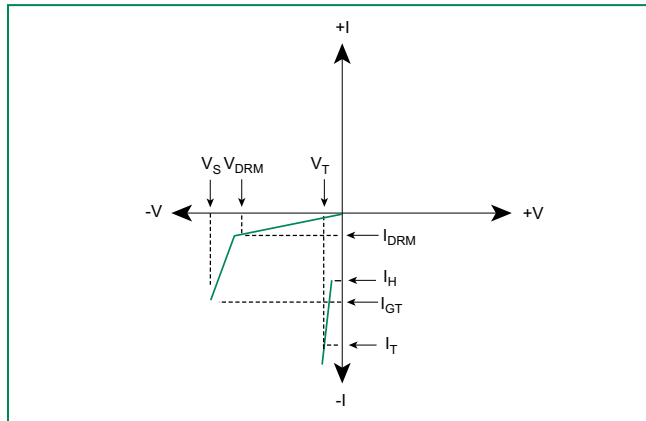

V-I Characteristics - Positive BattraX

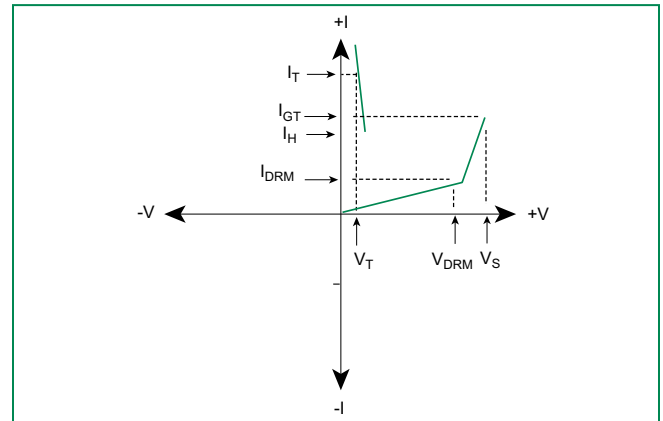

Normalized V_S Change vs. Junction Temperature

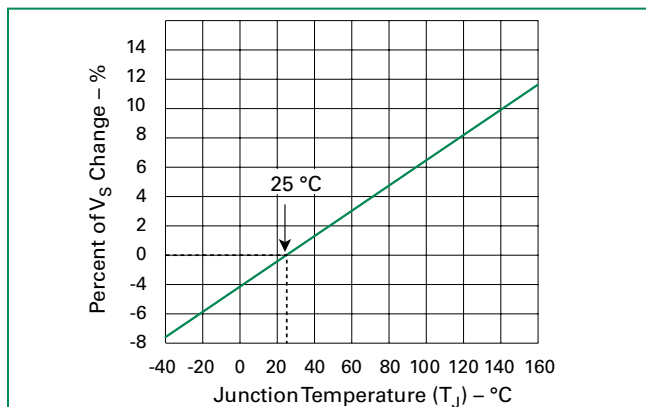

Normalized DC Holding Current vs. Case Temperature

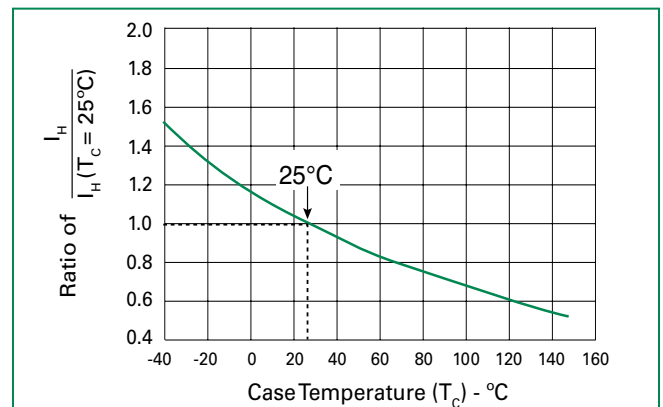

$t_r \times t_d$ Pulse Waveform

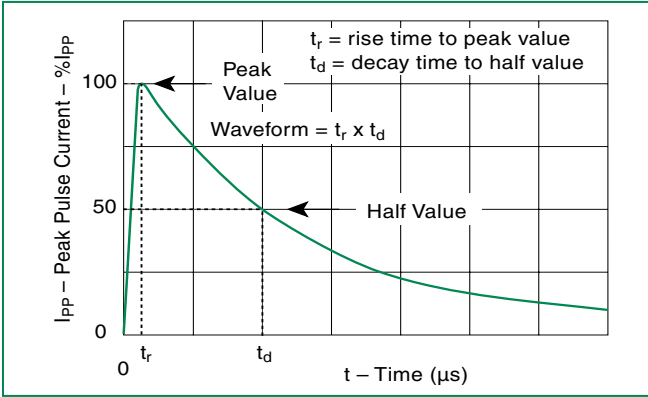

Physical Specifications

| | |
|------------------------|---|
| Lead Material | Copper Alloy |
| Terminal Finish | 100% Matte-Tin Plated |
| Body Material | UL recognized epoxy meeting flammability classification 94V-0 |

Environmental Specifications

| | |
|---|--|
| High Temp Voltage Blocking | 80% Rated V_{REF} Max. (V_{DC} Peak) +125°C or +150°C, 504 or 1008 hrs. MIL-STD-750 (Method 1040) JEDEC, JESD22-A-101 |
| Temp Cycling | -65°C to +150°C, 15 min. dwell, 10 up to 100 cycles. MIL-STD-750 (Method 1051) EIA/JEDEC, JESD22-A-104 |
| Biased Temp & Humidity | 52 V_{DC} (+85°C) 85%RH, 504 up to 1008 hrs. EIA/JEDEC, JESD22-A-101 |
| High Temp Storage | +150°C 1008 hrs. MIL-STD-750 (Method 1031) JEDEC, JESD22-A-101 |
| Low Temp Storage | -65°C, 1008 hrs. |
| Thermal Shock | 0°C to +100°C, 5 min. dwell, 10 sec. transfer, 10 cycles. MIL-STD-750 (Method 1056) JEDEC, JESD22-A-106 |
| Autoclave (Pressure Cooker Test) | +121°C, 100%RH, 2atm, 24 up to 168 hrs. EIA/JEDEC, JESD22-A-102 |
| Resistance to Solder Heat | +260°C, 30 secs. MIL-STD-750 (Method 2031) |
| Moisture Sensitivity Level | 85%RH, +85°C, 168 hrs., 3 reflow cycles (+260°C Peak). JEDEC-J-STD-020, Level 1 |

Soldering Parameters

| | | |
|--|-----------------------------------|--------------|
| Reflow Condition | Pb-Free assembly (see Fig. 1) | |
| Pre Heat | -Temperature Min ($T_{s(min)}$) | +150°C |
| | -Temperature Max ($T_{s(max)}$) | +200°C |
| | -Time (Min to Max) (t_s) | 60-180 secs. |
| Average ramp up rate (Liquidus Temp (T_L) to peak) | 3°C/sec. Max. | |
| $T_{s(max)}$ to T_L - Ramp-up Rate | 3°C/sec. Max. | |
| Reflow | -Temperature (T_L) (Liquidus) | +217°C |
| | -Temperature (t_L) | 60-150 secs. |
| Peak Temp (T_p) | +260(+0/-5)°C | |
| Time within 5°C of actual Peak Temp (t_p) | 30 secs. Max. | |
| Ramp-down Rate | 6°C/sec. Max. | |
| Time 25°C to Peak Temp (T_p) | 8 min. Max. | |
| Do not exceed | +260°C | |

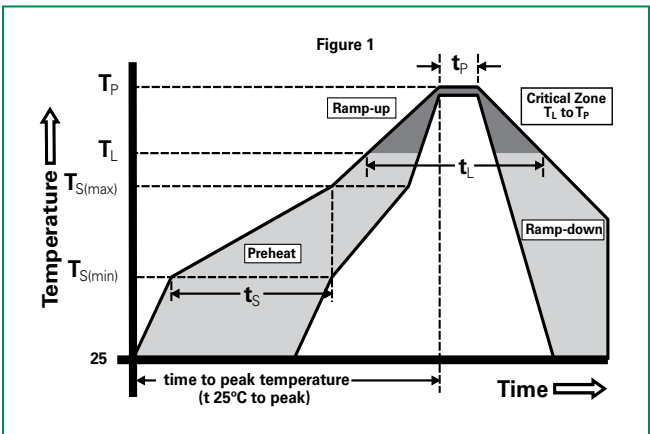

Part Numbering

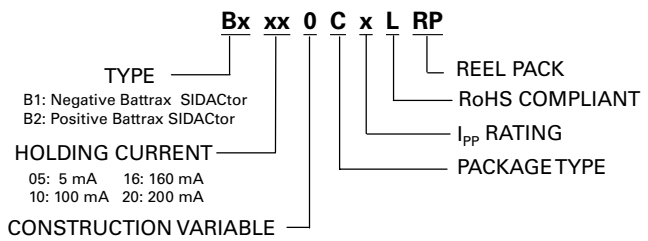

Part Marking

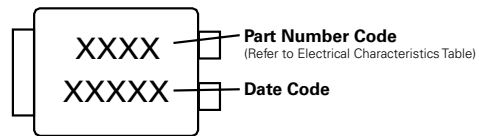

Dimensions — Modified DO-214AA

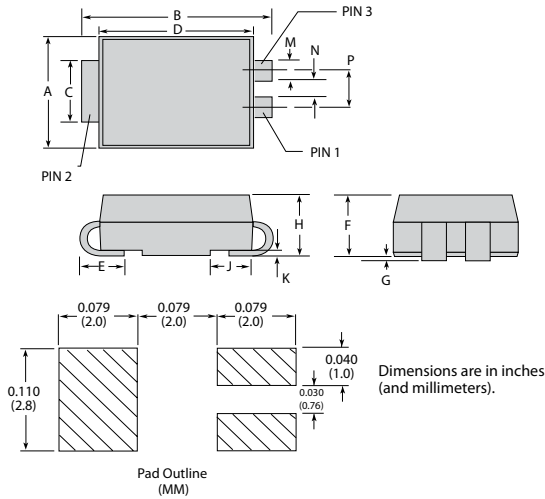

| Dimensions | Inches | | Millimeters | |
|------------|--------|-------|-------------|------|
| | Min | Max | Min | Max |
| A | 0.130 | 0.156 | 3.30 | 3.95 |
| B | 0.201 | 0.220 | 5.10 | 5.60 |
| C | 0.077 | 0.087 | 1.95 | 2.20 |
| D | 0.159 | 0.181 | 4.05 | 4.60 |
| E | 0.030 | 0.063 | 0.75 | 1.60 |
| F | 0.075 | 0.096 | 1.90 | 2.45 |
| G | 0.002 | 0.008 | 0.05 | 0.20 |
| H | 0.077 | 0.104 | 1.95 | 2.65 |
| K | 0.006 | 0.016 | 0.15 | 0.41 |
| M | 0.022 | 0.028 | 0.56 | 0.71 |
| N | 0.027 | 0.033 | 0.69 | 0.84 |
| P | 0.052 | 0.058 | 1.32 | 1.47 |

Packing Options

| Package Type | Description | Quantity | Added Suffix | Industry Standard |
|--------------|---|----------|--------------|-------------------|
| C | Modified DO-214AA 3-leaded Tape and Reel Pack | 2500 | RP | EIA-481-D |

Tape and Reel Specification — Modified DO-214AA

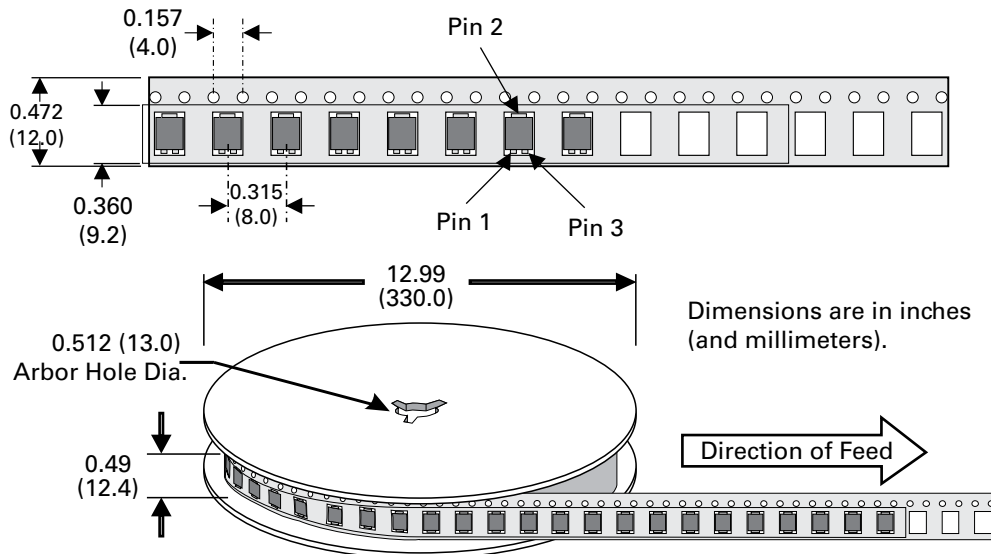

Additional Information



Datasheet



Resources



Samples