

POWR-SPEED® FUSES

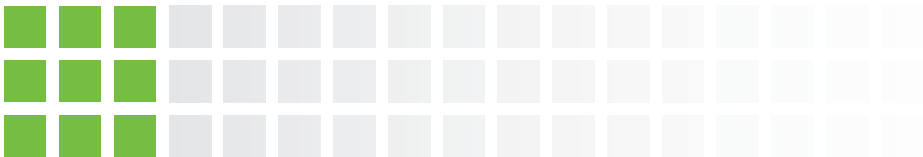

APPLICATION GUIDE



Expertise Applied | Answers Delivered



TABLE OF CONTENTS

1.0 INTRODUCTION 3

2.0 POWER SEMICONDUCTOR DEVICES 4

 2.1 Power Semiconductor Device Classification 4

3.0 OVERCURRENT PROTECTION FUNDAMENTALS 6

 3.1 Overcurrent Condition 6

 3.2 Overcurrent Types 6

 3.3 Protection of Power Semiconductor Devices 6

 3.4 What are High-Speed Fuses? 7

 3.5 High-Speed Fuse Construction 8

 3.6 High-Speed Fuse Styles 8

 3.7 Fuse Operation 10

 3.8 High-Speed Fuse Performance Characteristics 11

 3.8.1 Time Current Curve 11

 3.8.2 Peak Let-Thru Curve 14

 3.8.3 Total Clearing I²t Correction Factor Curve 17

 3.8.4 Peak Arc Voltage Curve 19

 3.8.5 Temperature Derating Curve 20

 3.8.6 Watt Loss Correction Factor Curve 21

4.0 SIZING GUIDELINES 22

 4.1 Rated Voltage 22

 4.1.1 Effect of Operating Frequency (E_f) 22

 4.1.2 Effect of Time Constant (E_{tc}) 23

 4.1.3 Effect of Regenerative Loads (E_{reg}) 23

 4.1.4 Effect of Complying Fuse Standard 23

 4.2 Rated Current 24

 4.2.1 Sizing of the High-Speed Fuse Rated Current 24

 4.3 Interrupting Rating 36

 4.4 Total Clearing I²t Value (Withstand Energy) 36

 4.5 Peak Arc-Voltage 36

5.0 APPLICATION CONSIDERATIONS 37

 5.1 Protection of Power Conversion Devices 37

 5.1.1 Protection Consideration for Rectifier Circuits 37

 5.1.2 Protection Consideration for Inverter Circuits 38

 5.1.3 Protection Consideration for DC Bus 39

 5.2 Protection for UL Motor Branch Circuits 39

 5.3 Protection of IGBT Based Devices 40

 5.4 High-Speed Fuses Connected in Parallel 40

 5.4.1 Estimation of Theoretical Performance 41

 5.4.2 Validation of Application Conditions for Proper Sizing 42

 5.4.3 Selection of Proper Mounting, Arrangement, and Accessories 43

 5.5 High-Speed Fuses Connected in Series 43

6.0 INSTALLATION GUIDELINES 44

7.0 POWR-SPEED RANGE 46

8.0 ACCESSORIES 47

 8.1 Microswitches 47

 8.2 Stud Blocks 48

9.0 TERMS & DEFINITIONS 49



1.0 INTRODUCTION

Power electronics are found in a wide range of applications, such as renewable power generation, transportation, utility and industrial facilities, power electronics control, and more.

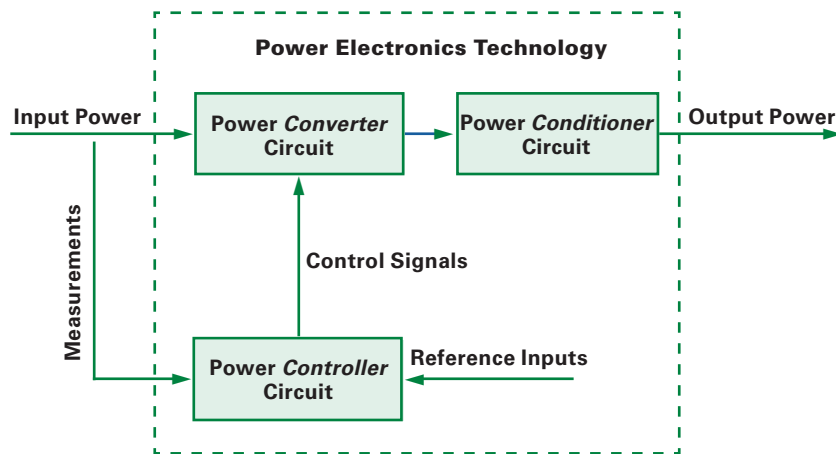

Figure 1. Power electronics system block diagram

Figure 1 illustrates a typical block diagram power electronics system, where input power received is transformed from one form to another (ac-dc-ac) using a converter circuit. This conversion is based on control signals received from the controller circuit which are then filtered and provided as output using the conditioner circuit. This typical setup is found in most power electronics applications.

A power semiconductor device is a high power electronic device that is used as a switch for control and conversion in electric power. The use of power semiconductor devices in modern power electronics is driven by the need for better power efficiency, with the ultimate goal of achieving as close to 100% power efficiency as possible. In addition to power efficiency, there is a need to make the device as small as possible, which is a driving factor as to why power semiconductors have replaced older electro-mechanical components.

Typical equipment using power semiconductor devices includes inverters, rectifiers, electric vehicle battery management systems, locomotive traction drives, industrial motor drives, factory automation systems, air conditioners, computers, telecom devices, battery chargers, and many more.

To protect these very sensitive power semiconductor devices from an overcurrent fault, an extremely fast acting and low energy let-through circuit protection device is needed. The only device available in the world to protect these sensitive devices are high-speed fuses.



2.0 POWER SEMICONDUCTOR DEVICES

The ability to switch (turn on/off) in an inductive circuit with minimum power loss is the key feature of power semiconductor devices.

Significant contributions were made by many researchers during the 1960s and 1970s which resulted in the introduction of many common power semiconductor devices that we still use today. The key driving factors for the development of power semiconductor devices are their low material consumption, low cost and their high efficiency.

Power semiconductor devices are a combination of power semiconductor components and a driver circuit. The components are made from materials such as silicon, germanium, and gallium arsenide, which are used primarily for the switching applications. The driver circuit is a low voltage electronic circuit that provides control signals to the power semiconductor components enabling it to turn on/off.

Typical power semiconductor components that are broadly used in application include:

- Insulated Gate Bipolar Transistor (IGBT)
- Metal Oxide Semiconductor Field Effect Transistor (MOSFET)
- Silicon Control Rectifier (SCR), also known as a thyristor
- Bipolar Junction Transistor (BJT)
- Gate Turn Off (GTO) thyristor
- Integrated Gate Commutated Thyristor (IGCT)
- Junction gate Field-Effect Transistor (JFET)
- Diodes

Power semiconductor devices are among the most complex devices used in today's electrical systems, and by their very nature, are sensitive to over-temperatures, overloads, voltage spikes, surges, and peak currents.

2.1 Power Semiconductor Device Classification

Power semiconductor devices are classified based on the number of terminals on each device. The most commonly used are two and three-terminal devices.

Two-terminal devices are those whose state depends on the external power circuit to which it is connected. PIN diodes and Schottky diodes are the most commonly available two-terminal devices.

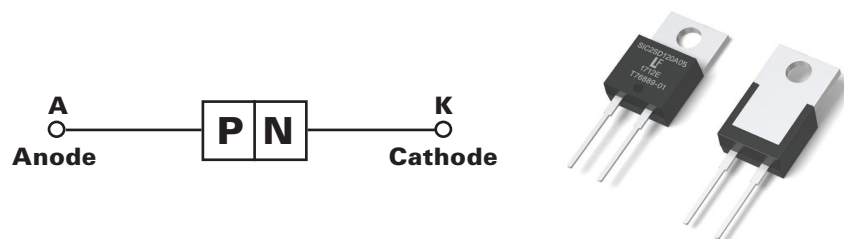

Figure 2. Two-terminal power semiconductor device



Three-terminal devices are those whose state is dependent on not only its external power circuit, but also the signal on its driving terminal (this terminal is generally referred to as the gate or base). Power MOSFETs, JFETs, IGBTs, BJTs, and SCRs are examples of three-terminal devices.

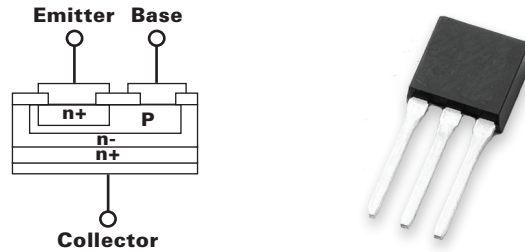

Figure 3. Three-terminal power semiconductor device

With the addition of isolation circuitry to these power semiconductor devices and when packaged as a single unit, the device is called a power semiconductor module or a power module. Figure 4 illustrates a typical power semiconductor module block diagram.

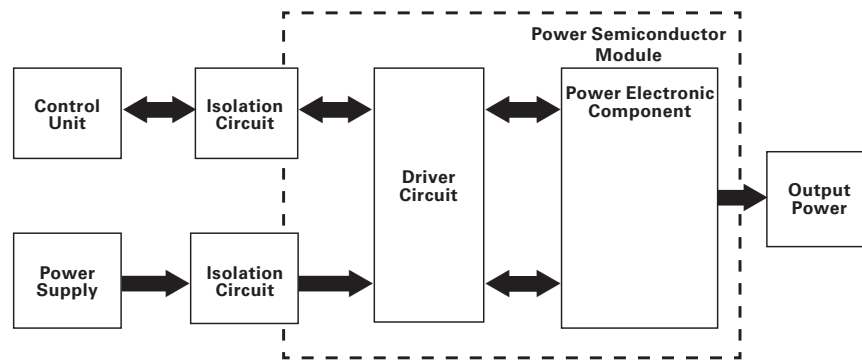

Figure 4. Power semiconductor module block diagram

Power semiconductor devices are packaged based on their current carrying capacity. Typically they are available in three different packaging configurations:

- Discrete packaging: up to a few hundred amperes
- Module packaging: 100 A to 4000 A
- Disc packaging: 1000 A to 6000 A



Figure 5. Power semiconductor device packaging



3.0 OVERCURRENT PROTECTION FUNDAMENTALS

Understanding the protection requirements and selecting the right fuse for your application can be an overwhelming, time-consuming process even for a seasoned power electronics design engineer. An important part of developing quality overcurrent protection is understanding system needs and overcurrent protective device fundamentals. In this section, the fundamentals of overcurrent protection, construction, and operating characteristics of high-speed fuses are discussed.

3.1 Overcurrent Condition

An overcurrent is any current larger than what the equipment, conductor, or device is rated to carry under specified conditions. Unless removed in time, even moderate overcurrents can quickly overheat system components, which in turn, can damage insulation, conductors, and equipment. Large overcurrents may melt conductors and vaporize insulation.

Very high currents produce magnetic forces that can bend and twist bus bars. These high currents can pull cables from their terminals and crack insulators and spacers. Uncontrolled overcurrents can result in fires, explosions, or the releasing of poisonous fumes. This not only damages electrical systems and equipment, but may cause injury or death to personnel nearby.

3.2 Overcurrent Types

There are two types of overcurrent fault conditions:

- Overload fault condition
- Short-circuit fault condition

Overload Fault Condition: Defined as an overcurrent that is confined to the normal current path, which if allowed to persist in the circuit, will cause damage to equipment and/or any connected wiring.

Overcurrent protective devices must disconnect circuits and equipment experiencing continuous overloads before any overheating occurs. Even moderate insulation overheating can seriously reduce the life of the components and/or equipment involved.

Typically, overcurrents less than 600% of the rated current of the device or application are termed as an overload fault current. Overload conditions often arise in applications when temporary surge currents persist in the system due to mechanical obstruction or jammed equipment conditions.

Short-Circuit Fault Condition: An overcurrent that flows outside its normal current path in the circuit is a short-circuit fault condition. A short-circuit fault is most commonly caused by an insulation breakdown or a faulty connection.

When a short-circuit fault occurs, the current bypasses the normal load and takes a shorter path, hence the term short-circuit. Short-circuit faults are typically divided into three categories: bolted faults, arcing faults and ground faults. Each type of short-circuit is defined in the Terms & Definitions section.

Typically, overcurrents greater than 600% of the rated current of the device or application are termed as a short-circuit fault current. Short-circuit conditions often arise in applications due to occurrences such as accidents, human error, dropped tools, misapplication, or insulation breakdown.

3.3. Protection of Power Semiconductor Devices

Power semiconductors combine high-power handling and fast switching capability in a small package size. These devices generate excessive heat during their normal operation and have low thermal withstand capacity. Additionally, any reduction in size impacts the devices ability to withstand overcurrent and overvoltage. This causes the device to require additional arrangements such as heat sinks and/or forced air/liquid cooling to



Figure 6. Power semiconductor device

dissipate the heat and help them run cool.

Performance of power semiconductor devices, **Figure 6**, are also greatly affected by the various stresses they handle during their operation such as electrical, mechanical, thermal, and environmental. When these stress levels exceed their withstanding limits, the devices tend to fail.

Thermal stress caused by various application conditions is identified as the major factor for semiconductor failure and can result in catastrophic conditions such as case rupture, fire, and explosion which can obviously cause extensive damage.

High-speed fuses have proven to be the protection devices that offer the proper level of protection to these sensitive power semiconductor devices.

3.4 What are High-Speed Fuses?

High-speed fuses are thermal, current-controlled devices used for semiconductor electrical circuit protection. They have a specially designed element profile and body construction to offer all the necessary short-circuit characteristics required for protection of semiconductor devices such as low energy let-through (I^2t), low peak currents (I_{PEAK}), low arc voltage and high heat dissipation.

This type of fuse consists of one or more current carrying elements that are enclosed within a chamber. The chamber is fitted with contacts (also known as blade/end-bells or terminations) so that the fuse may be readily inserted into or removed from an electrical circuit. Unlike general industrial fuses, high-speed fuses do not have intentional time-delay features.

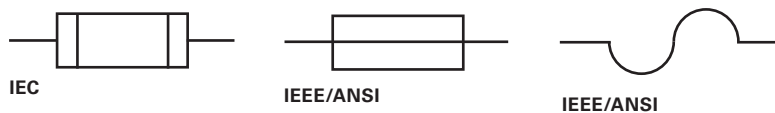

Figure 7. Representation of a fuse in an electrical circuit across various international standards

Sometimes referred to as a rectifier fuse, ultra-fast acting fuse, ultra-quick fuse, very fast-acting fuse, or semiconductor fuse, these overcurrent protection devices are known as high-speed fuses.

High-speed fuses are classified into two broad categories: full range high-speed fuses and partial range high-speed fuses. The IEC 60269 standard classifies fuse operating characteristics by utilization category, represented in the form of a two-letter alphabetical symbol/code (e.g. gG, aR, gR, aM, etc.)

Full Range High-Speed Fuses: Fuses in this category offer protection to both overload and short-circuit overcurrent conditions and have an assigned utilization category symbol gR. The first letter 'g' denotes full range protection while the second letter 'R' denotes semiconductor device application.

Partial Range High-Speed Fuses: Fuses in this category offer protection to only short-circuit overcurrent condition and have an assigned utilization category symbol aR. In this case, the first letter "a" denotes partial range protection while the second letter 'R' denotes semiconductor device application.



3.5 High-Speed Fuse Construction

The design and construction of high-speed fuses are unique as is their size and terminations. This is done to avoid misapplication of these fuses to any other general industrial applications in the field. Superior grade materials are used for high-speed fuse construction and are described below.

Element: High-speed fuses contain one or more current sensitive elements. Each element has a reduced cross section at one or more points. The reduced cross sections provide a measured resistance in each element.

The resistance of each element and the number of elements used in each fuse typically determines the current rating of the fuse. High-speed fuses contain elements made of silver, silver-plated copper, copper or other suitable materials.

Body Material: The most common body material used in high-speed fuses is glass-reinforced melamine and high grade ceramics. Glass-melamine is strong and break resistant, whereas ceramic has higher heat dissipation and temperature withstand capabilities.

Mounting Terminals: Typical high-speed fuse terminals consist of a copper alloy material. Some lower ampere ratings are drawn-brass to provide proper stress relief. Terminals of these fuses are also typically plated to reduce corrosion and to provide low-resistance connections.

Filler Material: High-speed fuses contain filler, which is primarily used to help extinguish arcing that occurs during current interruption. High grade quartz silica crystal filler material is used which contributes to the fuse’s current-limiting ability. Additionally, fillers aid with heat balance within the fuse while providing stability to the elements. This stability allows for smaller element cross sections to be used which, improves short-circuit performance.

3.6 High-Speed Fuse Styles

High-speed fuse styles are broadly classified based on dimension, mounting, and origin. The most common styles are:

- North American Traditional Round Body
- Square Body
- Cylindrical or Ferrule
- British Standard (BS88) Bolted

North American Traditional Round Body: These round-body bolted style high-speed fuses (**Figures 8 and 9**) are the most common in North America for protecting power semiconductor devices. These fuses are made of premium grade glass-melamine bodies, copper terminals, high grade quartz silica filler, and operating mechanism with 99.9 % pure silver elements.

The glass-melamine body absorbs the heat dissipated by the fuse. Silver-plated copper terminals offer excellent electrical contact to the fuse holder or bus bar. High grade quartz silica quenches the arc produced during fuse operation. The silver elements are uniquely designed with reduced cross-section areas to carry the rated current continuously. During an overcurrent fault, the elements melt at those reduced sections much faster, thereby clearing the overcurrent fault and limiting energy let-through to any downstream devices.



Figure 8. Cut-away of high-speed fuse



Figure 9. North American round body style fuses

Square Body: These high-speed fuses (**Figures 10a and 10b**) are made with a premium grade ceramic body, silver-plated copper alloy terminals, high grade quartz silica filler, and an operating mechanism containing 99.9 % pure silver elements. These fuses are available in different sizes to meet the wide range of electrical requirements demanded by modern power semiconductor devices.



Figure 10a. PSR series

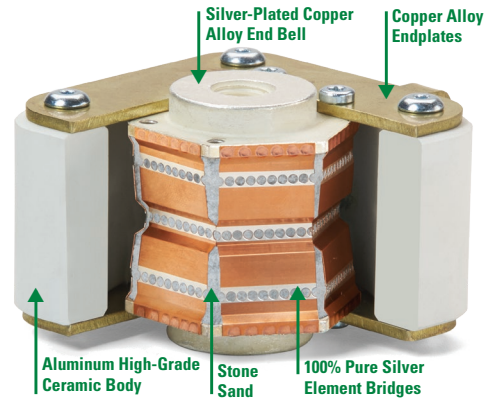

Figure 10b. Square body style fuses

The ceramic body has better heat withstand capabilities and offers higher resistance to arcing compared to the melamine material. The core in these fuses is made of multiple, parallel rows of specially designed silver or copper-silver elements that are designed to carry the rated current and melt during the overcurrent condition. The filler inside these fuses is high-grade quartz silica, however, unlike other fuses that have loose filler, this filler is in a solidified state referred to as stone sand. This stone sand design offers superior arc quenching capabilities, low energy let-through and improved dc performance.

Cylindrical or Ferrule Body: Cylindrical or ferrule style high-speed fuses (**Figures 11a and 11b**) are widely preferred by users thanks to their compact size and ability to be mounted directly to the printed circuit boards. Typical applications of these fuses include power supplies and control circuits. These fuses are made of melamine or ceramic bodies, while the end caps are typically a plated copper material to provide better conductivity. The elements inside are pure silver and are filled with high grade quartz silica filler.



Figure 11a. L25S series

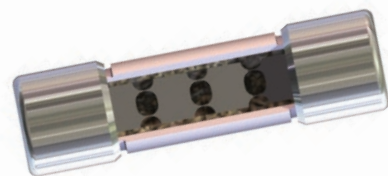

Figure 11b. Cylindrical or ferrule style fuses

Cylindrical or ferrule style high-speed fuses are offered in standard case sizes including:

- 10.3 mm x 38.1 mm
- 14.3 mm x 50.8 mm
- 20.6 mm x 50.8 mm
- 20.6 mm x 127.0 mm



3.7 Fuse Operation

In terms of how a fuse operates, the fusible element inside a fuse simply melts to protect the downstream device to which it is connected. Thus, fuses are often referred to as the sacrificial device in the circuit.

Fusible elements are specially designed to carry a specified amount of current continuously without opening. This is referred to as the rated current of the fuse. When electric current flows through these element bridges or restrictions, heat is generated. Until there is a balance in heat transfer (where the heat generated equals the heat dissipated) the fuse element(s) continue to carry the current as intended.

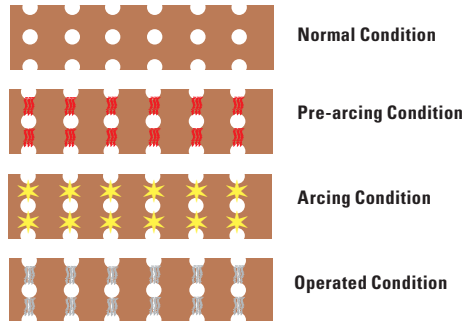

Figure 12. Changes to a fuse element during its operation

When there is an imbalance in heat transfer due to overcurrent conditions such as an overload or short-circuit occurrence, the amount of heat generated is greater than the heat dissipated. This causes a rise in temperature at the fusible element’s restrictions or weak points.

When this rise in temperature reaches the melting point of the fusible element (1,984 °F / 1,085 °C for copper or 1,763 °F / 962 °C for silver), the element bridges start to melt and break, resulting in an interruption of current flow through the fuse to the circuit.

In the event of a short-circuit condition, the fusible element(s) will begin to melt and then separate in just a few milliseconds. Yet during this time, an arc is generated within the fuse which in turn, is quenched or extinguished by the quartz silica sand filler material. The graph below shows the performance of current and voltage within the fuse during its operation.

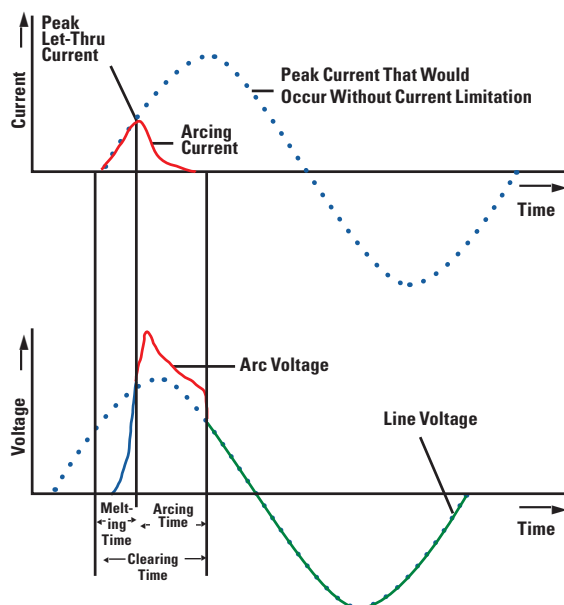

Figure 13. Performance of current and voltage inside a fuse during its operation



Thermal energy generated during the interruption of fault current by the fuse is usually expressed in Joules and commonly referred to as amperes squared seconds (A^2s or I^2t). It is proportional to the square of the current ('I' in amperes) during the operating time ('t' in seconds). The thermal energy generated is represented as melting I^2t , arcing I^2t , and clearing I^2t .

Melting I^2t : This is the heat energy passed by a fuse after an overcurrent occurs and until the fuse element melts. It equals the rms current squared multiplied by the melting time (in seconds).

Arcing I^2t : This is the heat energy passed by a fuse during its arcing time. It is equal to the rms arcing current squared, multiplied by the arcing time (in seconds).

Clearing I^2t : Also known as total clearing I^2t , this is I^2t through an overcurrent device from the inception of the overcurrent until the current is completely interrupted. Clearing I^2t is the sum of melting I^2t plus the arcing I^2t .

3.8 High-Speed Fuse Performance Characteristics

Performance capabilities of high-speed fuses are determined in the form of various characteristic curves where two or more electrical performances are compared and represented graphically. Typical high-speed fuse characteristic curves include:

- Time Current Curve
- Watt Loss Performance Curve
- Temperature Derating Curve
- Peak Let-through Current Curve
- Arc Voltage Curve
- I^2t Curve

3.8.1 Time Current Curve (TCC)

A high-speed fuse TCC is a graphical representation or performance plot of the fuse's virtual pre-arcing (melting) time at any given prospective symmetrical (fault) current. It is generated based on standard test conditions and at an ambient temperature range of 20 °C to 25 °C.

A TCC represents the inverse time-current relation characteristic of fuses, illustrating how the pre-arcing (or melting) time of a fuse decreases with the increase in prospective symmetrical (fault) current. A TCC is used to determine a fuse's melting time for a given symmetrical (fault) current and to select the change right to proper fuse rating for an application.

The X-axis of a TCC represents the symmetrical rms fault current in amperes. The Y-axis denotes the virtual pre-arcing (melting) time ($T_{pre-arc}$) for the fuse. This is the time span from initiation of an overcurrent condition to the instant arcing begins inside the fuse.

To determine the melting time for a fuse, start by locating the symmetrical (fault) current on the X-axis (reference point A) as shown in **Figure 14**. Extend a line from point A upward until it intersects the fuse TC curve at point B. Then move to the left to identify the corresponding value on the Y-axis (referenced to as point C) which represents the fuse's pre-arcing (melting) time.



In the example in **Figure 14**, the symmetrical (fault) current available for this application is 1800 A which is identified in the X-axis as point A. Follow the line extending from point A up until it meets the TCC at point B. Then moving left to the Y-axis (at point C) determines the pre-arcing (melting) time for the fuse selected = 0.002 seconds.

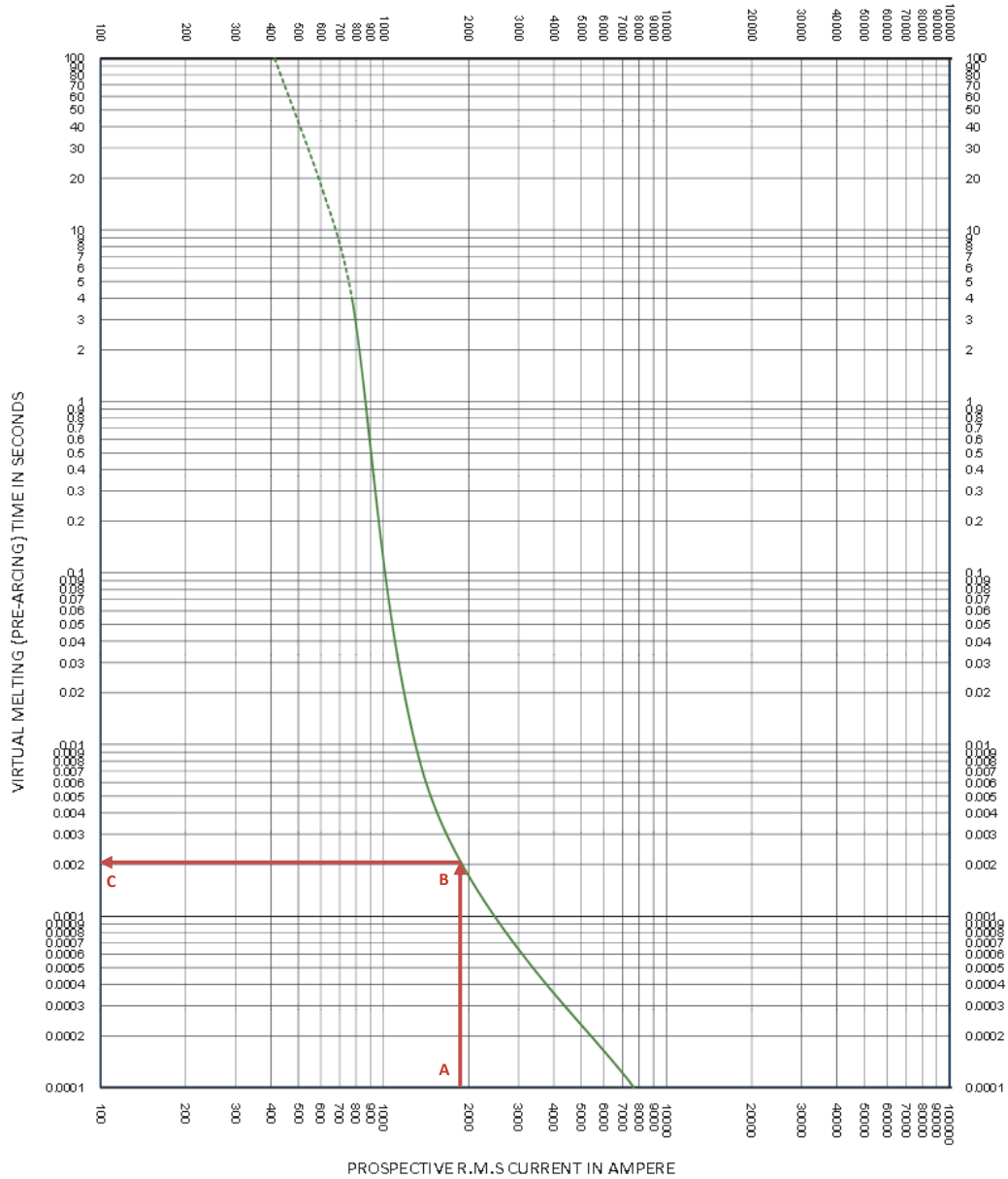

Figure 14. Time current characteristic curve – pre-arcing (melting) time determination



Unsafe Operating Region: The short-circuit currents for which a high-speed fuse offers protection is identified by a solid line on its TCC. Current ranges outside the fuse protection limits (typically the low overload fault currents) are represented by a dotted line on their TCC. The intersection of the solid and dotted lines represents the minimum breaking current for the fuse.

Due to the thermal risk that prevails while applying high-speed fuses at low overcurrents, it is not recommended that they be operated in this dotted line region.

Figure 15 is a typical example of a partial range high-speed fuse TCC that has the solid and dotted line regions. The shaded zone identified at the top of the figure represents the unsafe operating region for this fuse.

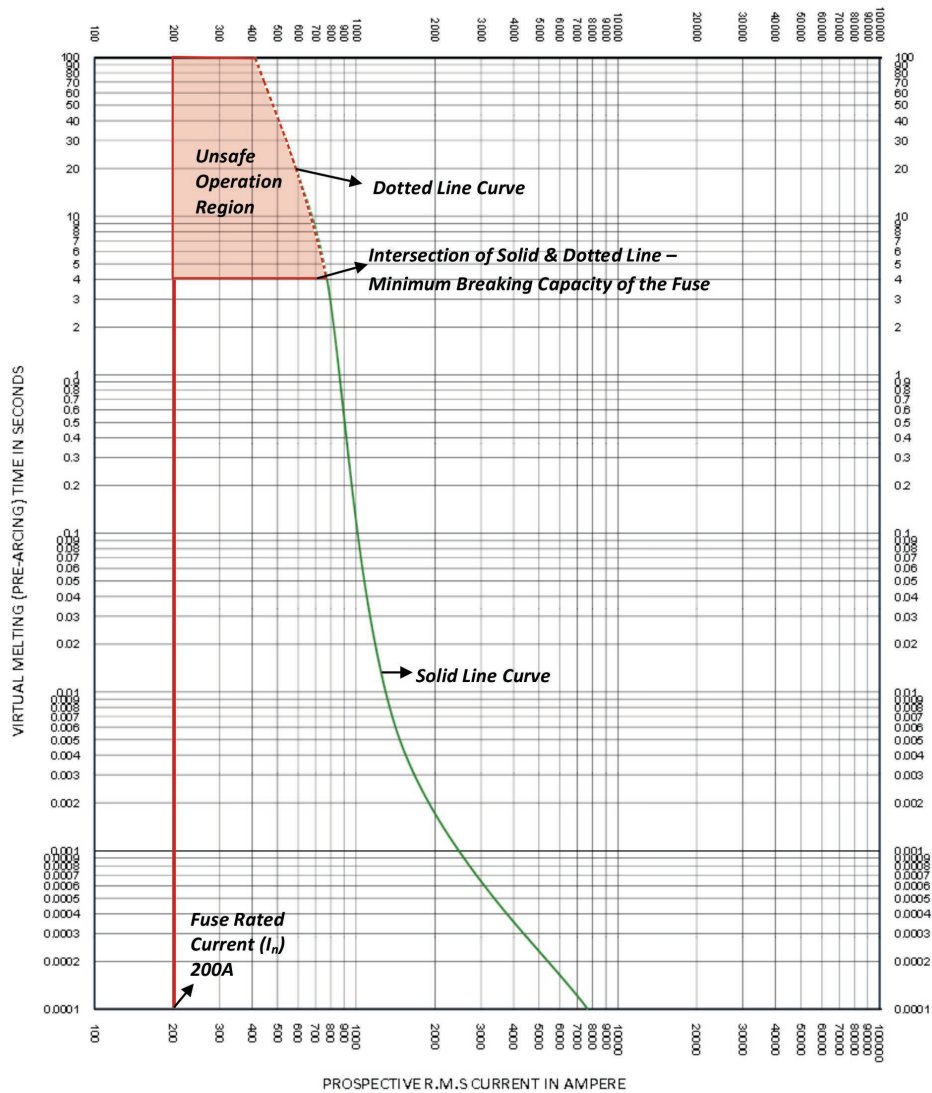

Figure 15. Time current characteristic curve – safe and unsafe operation region determination

While selecting high-speed fuses for varying load current applications, care should be taken such that the load current of the application does not fall into the unsafe operation region of the fuse selected.



3.8.2 Peak Let-Thru Curve

Peak let-through current curves illustrate the maximum instantaneous current through the fuse during its total clearing time. This represents the current limiting ability of a fuse. Peak let-through curves for Littelfuse high-speed fuses are available on individual fuse series datasheets. These curves are useful in determining whether a given fuse can properly protect a specific piece of equipment.

Fuses that are current-limiting open severe short-circuits within the first half-cycle after the fault occurs. Current-limiting fuses also reduce the peak current of the available fault current to a value less than would occur without the fuse. This reduction is shown in **Figure 16**.

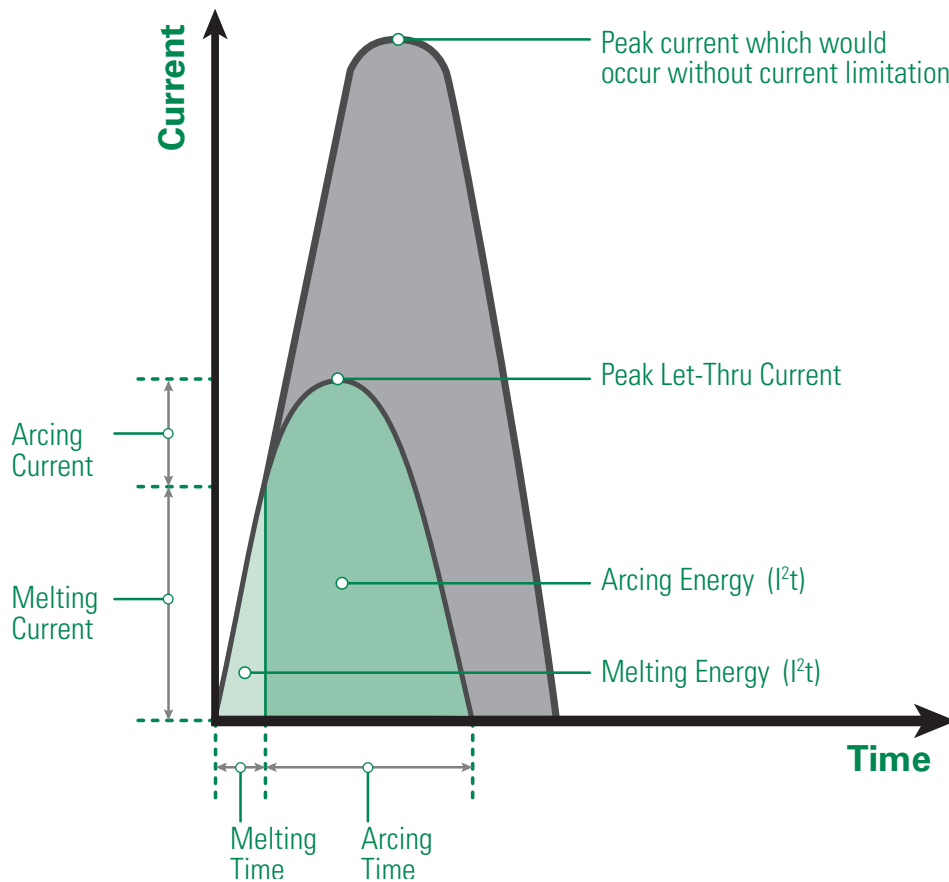

Figure 16. Current limiting effect of fuses



A fuse’s current-limiting effects are shown graphically on peak let-through curves as shown in **Figure 17**. The values across the curve’s bottom represent the available (also referred to as potential or prospective) rms symmetrical fault current. The values along the curve’s left side represents the instantaneous available peak current and the peak let-through current for various fuse ratings.

In a circuit with a typical 15 % short-circuit power factor, the instantaneous peak of the available current is approximately 2.3 times the rms symmetrical value. This is represented by the A–B line on the curve that has a 2.3:1 slope.

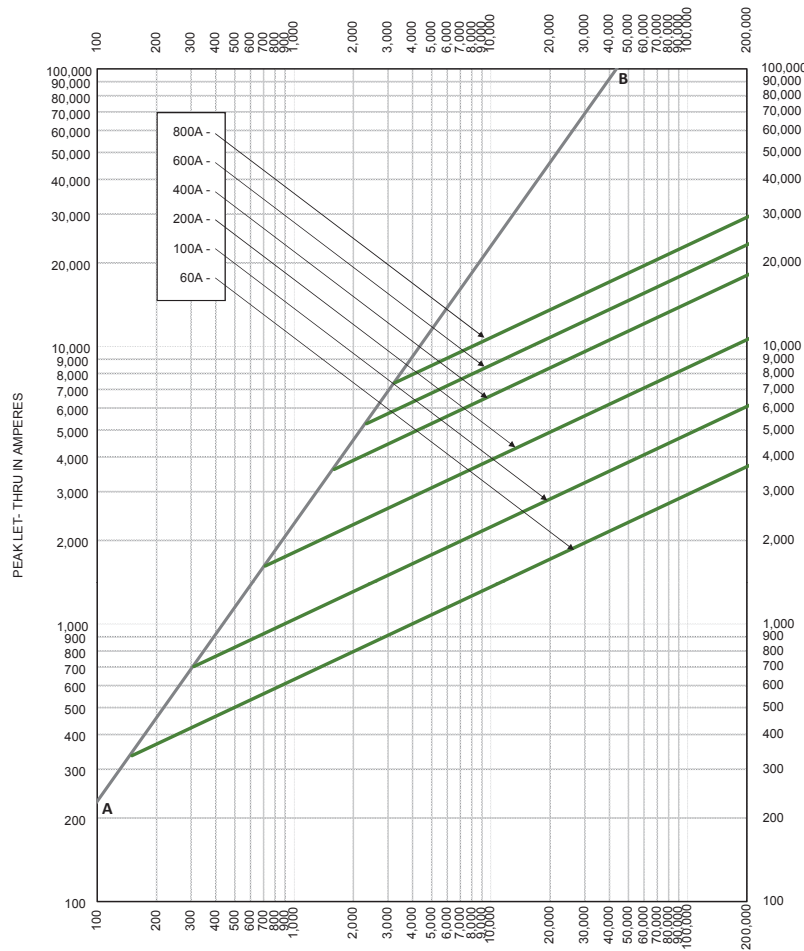

Figure 17. Peak let-through curves

The diagonal curves that branch off the A–B line illustrate the current-limiting effects of different fuse ampere ratings for a given fuse series.

A current limiting fuse, when interrupting current within its current-limiting range, reduces the current in the faulted circuit. The reduction is substantially less than that obtainable in the same circuit if the device was replaced with a solid conductor having comparable impedance.

This is important because the magnetic force created by current flow is a function of the peak current squared. If the peak let-through current of the current-limiting fuse is one-tenth of the available peak, the magnetic force is reduced to less than 1/100 of what would occur without the fuse.



Using the Peak Let-Through Charts (“Up-Over-and-Down”): Refer to **Figure 18**. For a given available fault-current of 100,000 rms amperes, determine whether a 600 A, 500 V L50QS series fuse can sufficiently protect equipment that has a 22,000 A short-circuit rating.

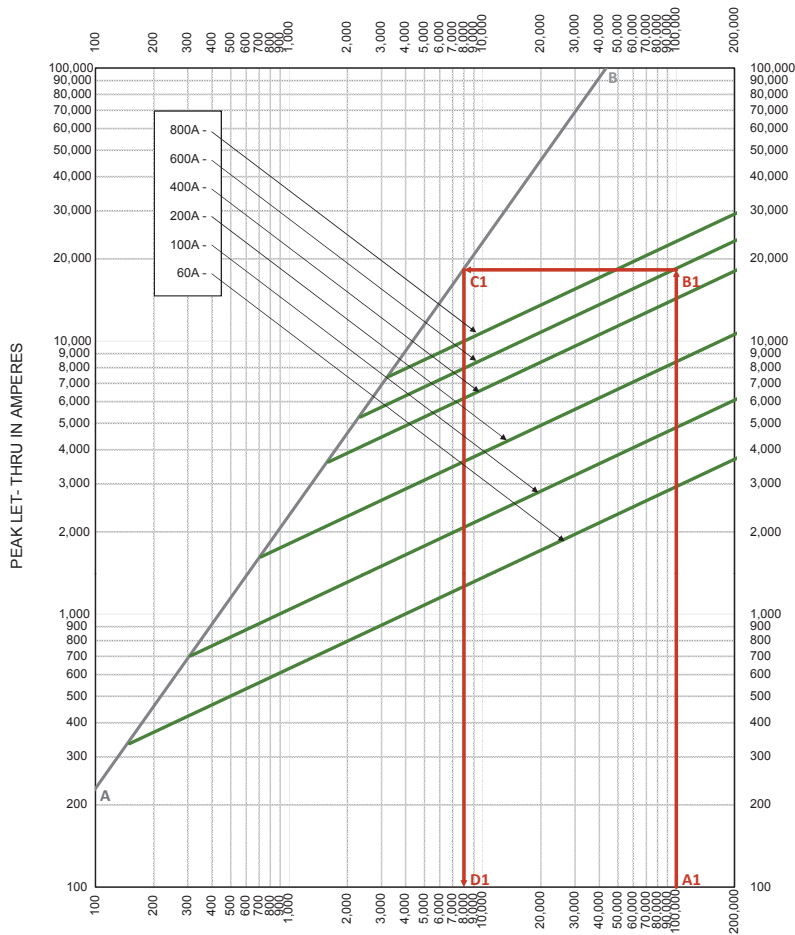

Figure 18. L50QS series peak let-through curve

Start by locating the 100,000 A available fault-current on the bottom of the curve (point A1) and follow this value upwards to the intersection with the 600 A fuse curve (point B1). Next, follow the point horizontally to the left to intersect with the A-B line (point C1). Finally, read down to the bottom of the curve (point D1) to read a value of approximately 8,000 A (let-through current).

Based on the analysis, the selected fuse has reduced the 100,000 A available current to an apparent or equivalent 8,000 A. This fuse can now be used to safely protect the connected piece of equipment in this application and its 22,000 A short-circuit rating.



3.8.3 Total Clearing I²t Correction Factor Curve

Ampere-squared-seconds, also known as I²t, is a means of describing the thermal energy generated by current flow. When a fuse is interrupting a current within its current-limiting range, the term is usually expressed as melting, arcing, or total clearing I²t. Total clearing I²t of the fuse selected should be lesser than the melting/withstand I²t of the semiconductor device terminals or case.

Figure 19 shows the melting I²t and total clearing I²t values of a typical high-speed fuse. The figure illustrates an older way of representing the I²t values in graphical format where the X-axis of the curve represents the rms prospective short-circuit fault current expressed in kiloamperes, and the Y-axis represents the I²t value expressed in ampere-squared seconds (A²s). Melting and clearing I²t values at different prospective fault currents are plotted in this curve.

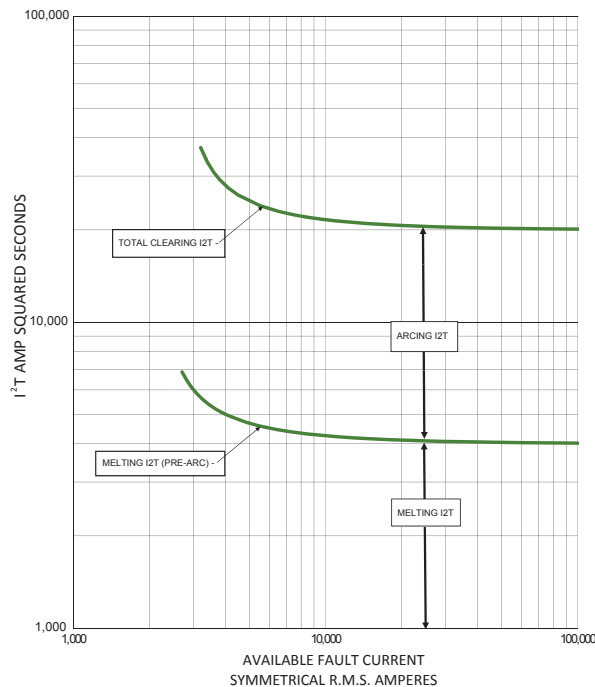

Figure 19. I²t characteristic curve

Melting I²t and total clearing I²t curves are higher for low levels of short circuit fault currents as it takes longer time to melt the fuse element. By comparison, for higher level short circuit, the fault current I²t curve remains constant.

These curves are no longer published as it has become a general industrial practice to publish the melting and total clearing I²t when tested at rated voltage in table format. I²t value for other voltages lower than the rated voltage are determined using an I²t correction factor curve.

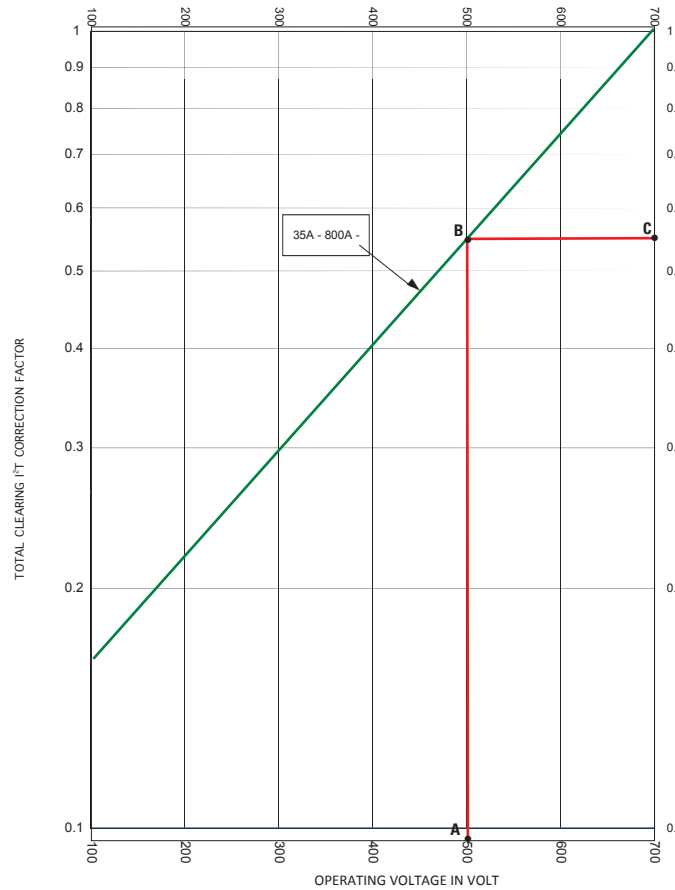

Figure 20. Total clearing I²t correction factor curve

Figure 20 shows the total clearing I²t correction factor curve for Littelfuse L70S Series high-speed fuse. The X-axis represents the application’s operating voltage in volts, while the Y-axis represents the total clearing I²t correction factor, which is the ratio between the total clearing I²t values measured at a reduced voltage and the total clearing I²t value at rated voltage.

Example:

Determine the total clearing I²t value of a L70S125 fuse at an operation voltage of 500 V ac.

The total clearing I²t value at rated voltage (700 V ac) from the respective fuse datasheet is 14,700 A²s.

Using the total clearing I²t correction factor curve, the correction factor at a reduced voltage of 500 V ac can be obtained by locating point A on the X-axis of the curve and following the voltage line up until it meets the correction factor curve at point B. The corresponding value on the Y-axis at point C represents the correction factor, which is 0.55.

Next, multiply the correction factor of 0.55 to the total clearing I²t value of the rated voltage (in this example 14,700 A²s) to determine the total clearing I²t value. So for this example, at a reduced voltage of 500 V ac, the L70S125 fuse has a total clearing I²t value of 8,085 A²s (14,700 A²s x 0.55 = 8,085 A²s).

This I²t correction factor curve greatly assists when selecting fuses for application wherein fuses are used at reduced or varying voltage environment. During the fuse selection process, care should be taken such that the I²t value of the fuse selected should be less than the withstand rating of the semiconductor device component in order to ensure proper fuse protection.



3.8.4 Peak Arc Voltage Curve

Arc (arcing) voltage is a transient voltage that occurs across an overcurrent protection device during the arcing time. It is usually expressed as peak instantaneous voltage (V_{PEAK} or E_{PEAK}).

When the bridges of the fusible element start to soften and melt during an overcurrent fault condition, arcing occurs inside the fuse. The arc produced inside the fuse conducts the flow of electrons or fault current until it is quenched by the filler material (silica sand). Other factors that affect the peak arc-voltage include the voltage rating and the power factor.

During this arcing process, the resistance of the arc causes a peak instantaneous arc voltage to appear across the fuse terminals that is greater than the system voltage. Arc voltage generated inside a high-speed fuse will appear across the power semiconductor device that is connected in series to the fuse as instantaneous reverse voltage.

Peak arc voltage curves for high-speed fuses provide the different levels of arc voltage generated within the fuse at varying operating voltages below its rated voltage. These curves are based on the results when tested at a 15 % power factor.

Figure 21 shows the level of peak arc voltage that may appear across the terminals of a 700 V ac high-speed fuse. For instance, consider a requirement to find the peak arc voltage for a 400 A fuse at a 500 V condition using the peak arc voltage curve. Start by locating the operating voltage (500 V) on the bottom of the curve at point A on the X-axis. Then follow this value upwards until it meets the 225–800 A curve at point B (which is the peak arc voltage curve of 400 A rating). From there, follow the point horizontally until it meets the peak arc voltage at point C on the Y-axis. The corresponding value of 950 V provides the peak arc voltage for a 400 A rated fuse at an operating voltage of 500 V.

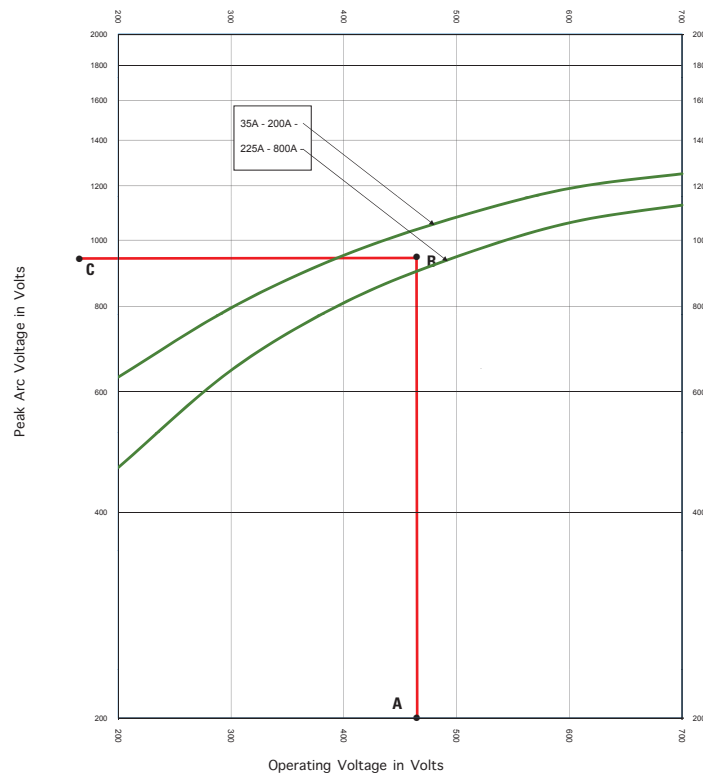

Figure 21. Peak arc voltage curve for Littelfuse high-speed fuse

Care should be taken during the fuse selection process to ensure that this peak arc voltage (also termed as 'reverse voltage') is less than the power semiconductor device peak inverse voltage (PIV) to avoid semiconductor device breakdown.

Consult the datasheet for each high-speed fuse series to utilize the Littelfuse published peak arc voltage curves.



3.8.5 Temperature De-Rating Curve

The current-carrying capacity of a fuse depends upon the operating ambient temperature condition of the application where they are being used. It is reduced with an increase in ambient temperature, and vice-versa. A temperature derating curve can be used to determine this change in current carrying capacity across the operating temperature range of the fuse.

Temperature de-rating curves are specific to fuse types and are based on the ambient air temperature that is surrounding and immediately outside the fuse (generally within a few inches from the fuse). If the fuse is mounted to an enclosed fuse holder, then the ambient is the air temperature immediately surrounding the fuse holder. Temperature de-rating curves show both the widest ambient temperature range (X-axis) within which the fuse can be safely operated (also known as operating temperature range), as well as the corresponding de-rating factor to be applied to the rated current of the fuse.

To use the curve, first measure the ambient temperature for the application and locate that temperature on the X-axis (for example, reference point A1 as shown in **Figure 22**). Then extend a line upward from this reference point until it intersects with the de-rating curve. Then move left or right to find the corresponding percentage shown on the Y-axis. This identifies the necessary de-rating factor (uprating or downrating) to be applied to the rated current of the fuse rating selected for the application.

In the example shown here, the ambient condition of the application is 70 °C, as represented by reference point A1 on the X-axis. Extend a line upward until it intersects the de-rating curve. In this instance, the de-rating curve is below the 0% part of the Y-axis so there will be a down-rating for this application. Extend the line to the Y-axis on the right side of the curve to identify 20 % as the percentage factor of downrating necessary for the fuse selected for this application. In other words, the rated current of the fuse selected for this application should be reduced by 20 %, with the calculated current value becoming the new current rating for the fuse.

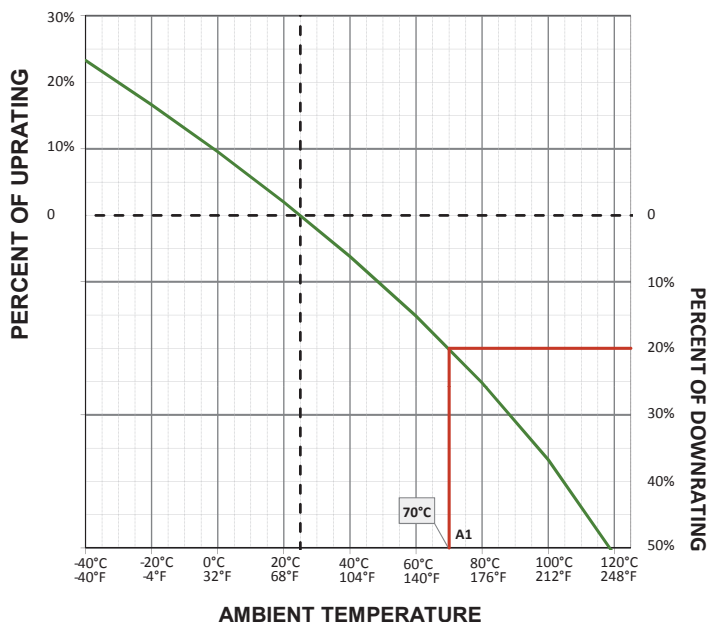

Figure 22. Temperature de-rating curve

To complete the example, let’s consider a 30 A fuse for this application. Based on the 70 °C ambient temperature involved a de-rating factor of -20 % is now applied for this fuse. The new current rating of the fuse now becomes 24 A (30 A–20 % = 24 A).

For Littelfuse high-speed fuses, the typical storage temperature would range from -20 °C to 60 °C at a relative humidity of 75 %. The operating temperature range would be -55 °C to +120 °C.



3.8.6 Watt Loss Correction Factor Curve

The amount of energy consumed by a fuse during its nominal operation is referred to as energy loss or watt loss. Global standards require watt loss values to be furnished by the fuse manufacturer and tested at 100 % of the rated current of the fuse.

In real world applications, high-speed fuses are typically not loaded up to 100 % of their rated current, but are loaded anywhere between 60 % and 80 % of the rated current. Littelfuse publishes watt loss values for high-speed fuses tested at both 100 % and 80 % of rated current. This data can be found in the form of an electrical characteristics table for each fuse in its datasheet, along with a watt loss correction factor re-rating curve that represents the watt loss performance of the fuse series between 30 % and 100 % of the rated current.

Figure 23 represents a typical watt loss correction factor curve for a high-speed fuse series. The X-axis of the curve represents the percentage of rated current, while the Y-axis shows the correction factor to be multiplied to the 100 % watt loss value of the fuse being used.

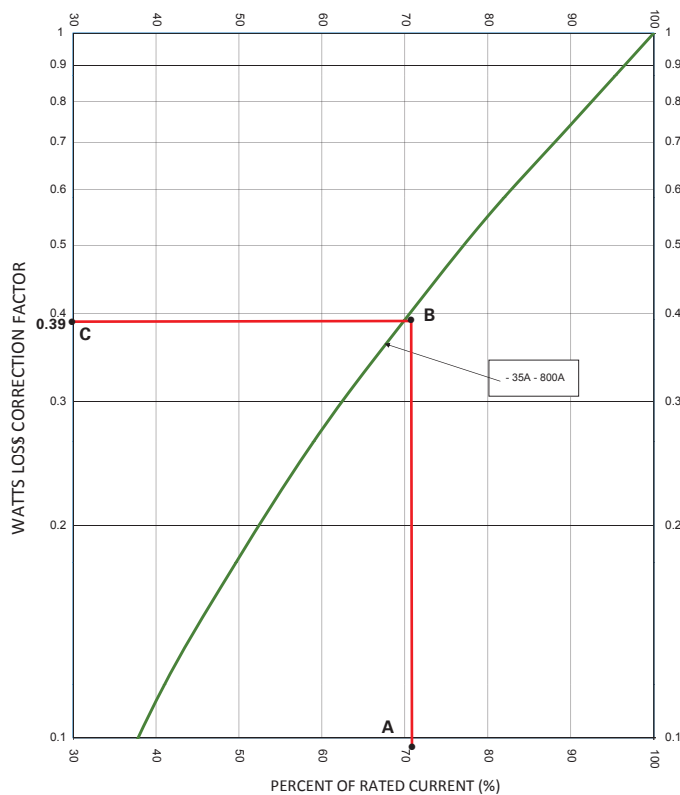

Figure 23. Watt loss correction factor curve

Example:

Determine the watt loss value for a fuse when loaded at 70 % of its rated current using the watt loss correction factor curve shown in **Figure 23**. The rated current watt loss from the fuse datasheet is 24 watts.

Looking at **Figure 23**, start by locating the required percentage of 70 % value on the X-axis (point A) and extend a line upward until it meets the watt loss curve (point B).

Then move to the left to identify the corresponding value on the Y-axis (point C) which represents the watt loss correction factor to be multiplied to the 100 % watt loss values for the fuse selected.

The watt loss correction factor identified from the curve at 70 % rated current is 0.39. Multiplying this factor to the 100 % watt loss value of the fuse results in, $24 \text{ W} \times 0.39 = 9.36 \text{ W}$

This 9.36 watts is the mathematical derived approximate watt loss value for the fuse when loaded at 70 % of its rated current.



4.0 SIZING GUIDELINES

The proper selection of high-speed fuses involves greater understanding and consideration of its product specifications such as rated voltage, rated current, interrupting rating, and melting and total clearing I²t ratings, and then sizing them appropriately to various application conditions. In this section, general industrial guidelines are discussed for sizing high-speed fuse specifications based on these influencing application conditions.

4.1 Rated Voltage

Rated voltage of a fuse is the maximum ac or dc voltage at which the fuse is designed to operate. Fuses may be rated for ac only, dc only, or both ac and dc. A fuse’s voltage rating must equal or exceed the application voltage where the fuse will be installed.

The ac voltage rating on the fuse label is the maximum open circuit rms voltage for which the fuse can be safely applied. But it’s also important to note that fuses used in dc circuits must be specifically rated for dc applications. The dc voltage rating on the fuse label is the maximum dc voltage where the fuse can be safely applied.

In some instances, and with certain limitations, an ac only rated fuse could be used on dc circuits. Please consult Littelfuse Technical Services to understand the safe dc voltage rating for applying such fuses. Most common application conditions that affect the rated voltage sizing of high-speed fuses are operating frequency, regenerative loads and adopted agency standards.

4.1.1 Effect of Operating Frequency (E_f)

The ac voltage rating of a fuse is determined by testing at a frequency between 45 Hz and 62 Hz per UL and IEC standards. Typically, application frequencies (up to 1 kHz) do not affect the performance of a fuse. However, at lower frequencies (below 45 Hz), the circuit tends to perform more like a dc circuit which can significantly affect the fuse’s ability to safely clear a fault current. In such an application, a fuse with a rated ac voltage higher than the application ac voltage would be recommended.

To determine the minimum rated ac voltage of a fuse at low frequency applications, the appropriate frequency correction factor (E_f) (see **Figure 24** below) should be factored to the application ac voltage to determine the proper fuse voltage rating.

The minimum rated ac voltage of a fuse can be determined by:

$$E_n \geq \frac{E}{E_f}$$

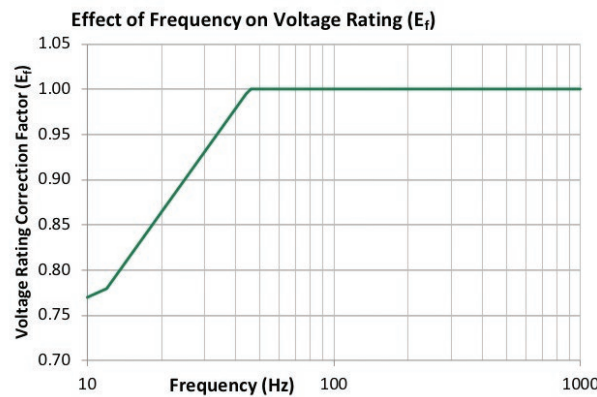

Figure 24. Frequency correction factor curve



Example:

Application Voltage Rating (E) = 480 V ac

Application Frequency = 30 Hz

Frequency Correction Factor (E_f) = 0.9

Minimum Fuse AC Voltage $E_n \geq \frac{E}{E_f} \geq \frac{480 \text{ V ac}}{0.9} \geq 533 \text{ V ac}$

And thus, the recommendation would be to use a 550 V ac or 600 V ac rated fuse.

4.1.2 Effect of Time Constant (E_{fc})

The ability of a dc rated high-speed fuse to safely interrupt dc overcurrents is influenced by the dc time constant (also known as the L/R ratio) of the circuit. In dc circuits, the inductance to resistance (L/R) ratio defines the rate of rise of fault current (di/dt). The dc circuit time constant is generally expressed in milliseconds (ms) and is the time it takes for the dc circuit to reach 63% of its final value.

The longer the time constant of the circuit, the more the burden on the fuse to safely interrupt the fault current. Littelfuse high-speed fuses are tested in circuits with time constant (L/R) no less than 10ms per the UL and IEC standards. When used in circuits with a time constant exceeding 10ms, high-speed fuses require additional rated voltage de-rating. Contact Littelfuse Technical Services for such applications.

4.1.3 Effect of Regenerative Loads (E_{reg})

When fuses are used in a regenerative power converter application where the mechanical energy of the motor and/or connected load is returned to the ac power source during braking, there is a chance of commutation fault. This is the worst-case fault in this circuit. During this fault, the application source ac voltage is superimposed upon the converter output dc voltage causing a sudden increase in system voltage. This affects the fuse's ability to safely clear the fault.

For a high-speed fuse to safely clear a commutation fault in a regenerative load application, a safety factor (E_{reg}) of 1.8 is applied to the application voltage rating (E) to determine the minimum rated voltage of the high-speed fuse (E_n).

$$E_n = E \times E_{reg} \quad \text{or} \quad E_n = E \times 1.8$$

For non-regenerative loads, the safety factor $E_{reg} = 1.0$

4.1.4 Effect of Complying Fuse Standard

High-speed fuses offered by Littelfuse are compliant to either UL, IEC, or in many cases, both standards depending on the fuse style. North American round body style fuses are compliant to the UL 248-13 standard and rated voltage testing is performed at 100 % of the ac voltage of the fuse.

In comparison, square body style fuses are tested to both IEC 60269-4 and UL 248-13 standards. Per the IEC standard, rated voltage testing is performed at 110 % of the ac voltage of the fuse, to factor in any application overload conditions.

When applying North American round body style fuses in an IEC application, an additional safety factor of 0.9 should be factored to the application voltage to determine the rated voltage of the fuse.



Minimum high-speed fuse rated voltage: $E_n = \frac{E}{0.9}$

So in summary, the rated voltage of a fuse is determined using the formula:

$$E_n = \frac{E \times E_{reg}}{E_f}$$

For North American style fuses used in IEC applications, the rated ac voltage of a fuse is determined by:

$$E_n = \frac{E \times E_{reg}}{0.9 \times E_f}$$

Where:

- E** = Application voltage rating
- E_{reg}** = Regenerative load safety factor
- E_f** = Frequency correction factor

4.2 Rated Current

The rated current of a high-speed fuse is defined as the continuous ac rms current (and the dc steady-state current, when rated for ac and dc) that the fuse is designed to carry under specified conditions defined by the complying standard (UL and IEC).

The rated current printed on the fuse label is determined based on testing performed at standard test conditions.

- **Ac Circuit Conditions:** Frequency range from 45 Hz to 62 Hz with an ambient temperature 20 °C ± 5 °C.
- **Dc Circuit Conditions:** A time constant (L/R) of 10ms or less with an ambient temperature of 20 °C ± 5 °C.

Typically, fuses are not always applied at standard test conditions. As a result, the sizing (or selecting) of the fuse's rated current is dependent on various application factors and conditions.

4.2.1 Sizing of the High-Speed Fuse Rated Current

The following steps explain how to size a high-speed fuse for various applications.

Step 1: Determine the Normal Full-Load Current of the Fuses

Depending on the location of the fuse in the power conversion circuitry (ac side or dc side), the load current through the fuse varies. In most cases this normal load current is generally available from the application design engineer.

For applications where normal full load current is not readily available, the value can be determined by calculating the rms current (ac side fusing) or the steady-state current (dc side fusing).

In power conversion applications, the challenge is determining this ac rms current and dc steady-state current (often stated as dc average current) due to the pulsating nature of the rectifier output current.

Figure 25 shows the relationship between ac rms current and dc average current for a single-phase unfiltered full-wave rectifier circuit.

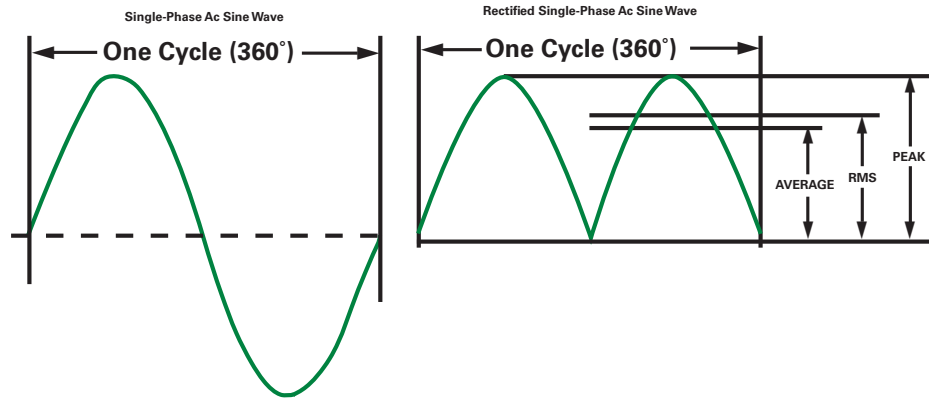

Figure 25. Relationship between ac rms current and dc average current for a single-phase unfiltered full-wave rectifier circuit.

Where,

I_{PEAK} = Peak Current

I_{AVG} = Dc Average (Output) Current

I_{RMS} = Ac RMS Current

$$I_{AVG} = 0.636 \times I_{PEAK}$$

Or

$$I_{PEAK} = I_{AVG} / 0.636$$

$$I_{RMS} = 0.707 \times I_{PEAK}$$

By substituting I_{PEAK} in the above equation,

$$I_{RMS} = (0.707 / 0.636) \times I_{AVG}$$

Ac Side Normal Full-load Current (I_{AL}): **$I_{RMS} = 1.11 \times I_{AVG}$**

Or

Dc Side Normal Full-load Current (I_{AL}): **$I_{AVG} = 0.9 \times I_{RMS}$**

The average dc current through the fuse is 90 % of the ac rms current (see **Figure 25**). Fuses located in the ac side of the circuit will see an rms current 1.11 times that of the dc average output current.

When multiple semiconductors (such as full-wave, parallel, three-phase, or similar circuits) along with multiple fuses are used in a circuit, current through each fuse depends on the location of the fuse in the circuit.

The examples below represent a few common rectifier circuit options with possible fuse placement locations shown along with the ac rms current running through the fuse (as calculated at 100 % dc steady-state load current).

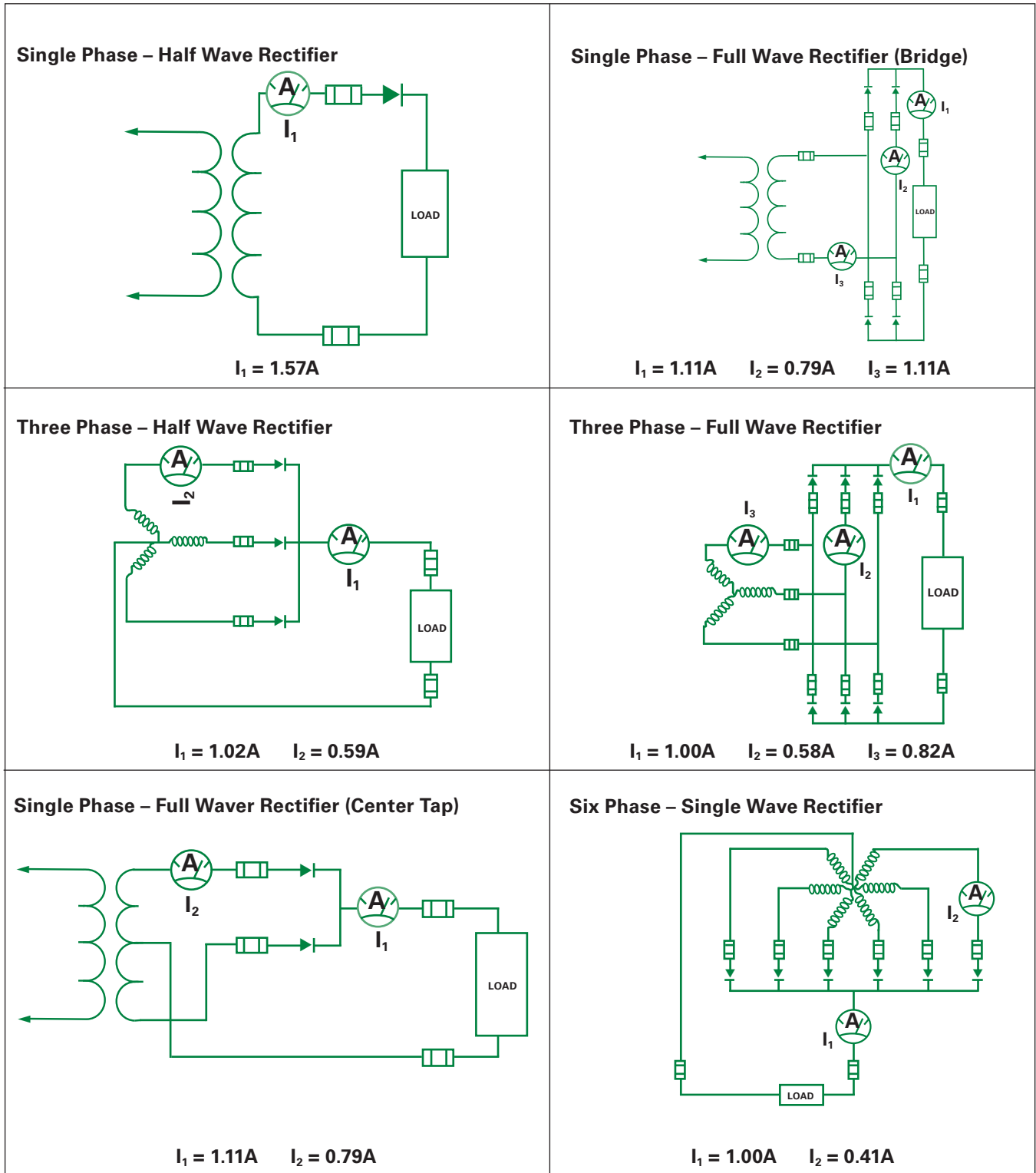

Figure 26. Typical rectifier circuits and locations of high-speed fuses in the circuitry



When the current through the fuse is constant and continues for one hour or more, then the calculated normal load current is similar to the ac rms current or the dc steady state current per the illustrations above.

However, for applications involving varying load current, especially when subjected to inrush current or cyclic current (regular-repeating identical current cycles), the normal load current through the fuse is obtained by calculating the rms current of one duty cycle, known as adjusted normal load current.

Figure 27 is a representation of a typical varying load cycle. The adjusted normal load current for this varying load cycles is provided by the formula,

$$I_{AL} = \sqrt{\frac{I_1^2 t_1 + I_2^2 t_2 + \dots + I_n^2 t_n}{T}}$$

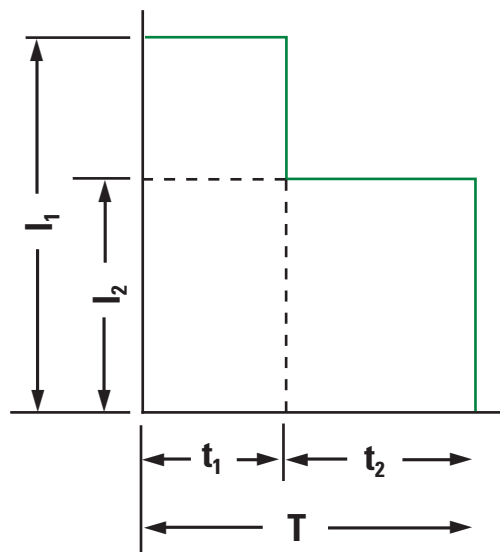

Figure 27. Varying load current (cyclic current)

Where,

- I₁, I₂...I_n:** Varying RMS load currents (amperes)
- t₁, t₂...t_n:** Corresponding current cycle duration (seconds)
- T:** Total duration of one varying load current cycle (Including any OFF period)

Example:

Determine the adjusted normal load current for the cyclic current shown in **Figure 28**.

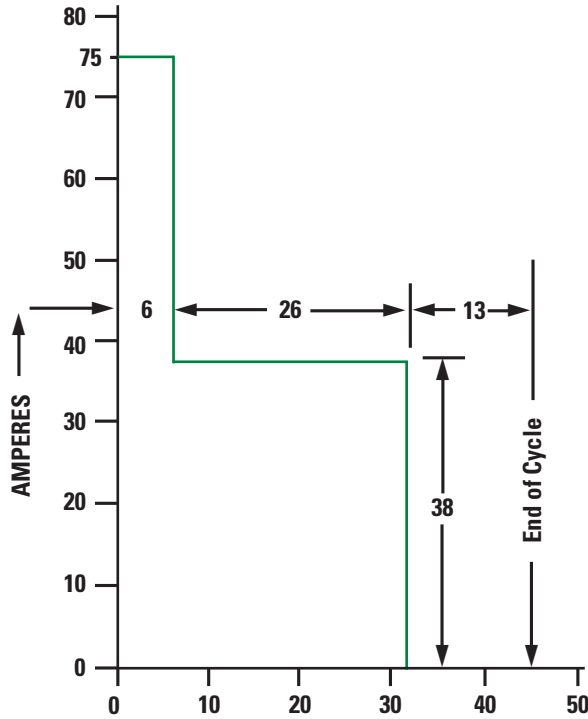

Figure 28. A cyclic current.

Where,

I₁: 75A

t₁: 6 Seconds

I₂: 38A

t₂: 26 Seconds

I₃: 0A

t₃: 13 Seconds

Total Time (T): 45 Seconds

$$I_{AL} = \sqrt{\frac{(I_1^2 * t_1) + (I_2^2 * t_2) + (I_3^2 * t_3)}{T}}$$

$$I_{AL} = \sqrt{\frac{(75^2 * 6) + (38^2 * 26) + (0^2 * 13)}{45}}$$

I_{AL} = 40A

For irregular current cycles, the adjusted load current must be calculated for a period of one hour, during which the largest effective surge current would occur.

Depending on the magnitude and duration of the surge current, the calculated adjusted normal load current (I_{AL}) may be substantially less than the surges in the system.

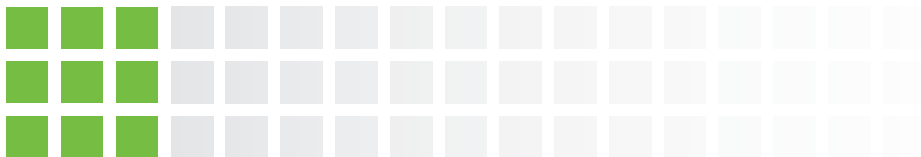

Other common scenarios observed in power semiconductor applications would involve having multiple power semiconductor devices connected in parallel (as shown in **Figure 29**). In this scenario called a multi-parallel connection, each device is protected by an individual high-speed fuse in each arm/leg of the power conversion circuit.

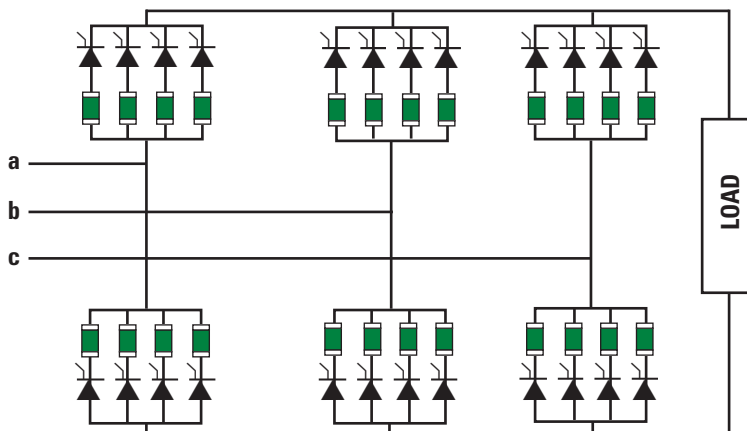

Figure 29. Multi-parallel connection in a rectifier circuit

In such situations, the load current through each arm/leg is shared between all parallel paths. Though load current sharing is typically not equal, as up to 20% of uneven sharing is allowed. Continuous operation of this multi-parallel circuitry with one less parallel path (due to fuse operation on an internal fault) is also possible. Thus, when determining the load current through the fuse in such multi-parallel circuits, both these conditions should be considered.

The normal load current (I_{AL}) through each fuse in a multi-parallel connection circuitry is determined by:

$$I_{AL} = \frac{I_{AL (LEG)}}{\left\{ \frac{N}{(1 + S)} \right\} - 1}$$

Where,

I_{AL(Leg)} = Total rms current in each arm/leg

N = Total number of parallel path in each arm/leg

S = Load current sharing factor (0 %-20 %)

The rated current of the high-speed fuse being selected can be determined by applying re-rating factors (computed in Step 2 below) to the normal load current (I_{AL}) determined from this section.



Step 2: How to determine the appropriate current rating of a high-speed fuse

As thermally sensitive devices, there are various application parameters that affect a fuse’s operation (melting). This, in turn, affects the overall current carrying capacity (rated current) of a fuse. The following are the application parameters and their corresponding correction factors that need to be considered while sizing a high-speed fuse.

The rated current of a high-speed fuse can be determined using the following formula:

$$I_N = \frac{I_{AL}}{F_{AT} * F_{FC} * F_{WR} * F_{HZ} * F_{SS} * F_{AL}}$$

Where,

- I_{AL} = Adjusted normal full-load current
- I_N = Rated current of high-speed fuse for the application
- F_{AT} = Ambient temperature correction factor
- F_{FC} = Forced cooling correction factor
- F_{WR} = Wiring connection factor
- F_{SS} = Switching correction factor
- F_{AL} = Altitude correction factor

2a: Ambient Temperature Fuses are affected by the air temperature immediately surrounding it (ambient temperature) during its operation. Typically, high-speed fuses are tested at standard test conditions of 20 °C ± 5 °C and can be applied at a wide operation temperature range of -50 °C to +125 °C. When fuses are operated at ambient temperatures outside their standard testing range, the appropriate ambient temperature correction factor needs to be computed and factored to properly select the fuse rating. The ambient temperature correction factor (F_{AT}) is determined by the formula

$$F_{AT} = \sqrt{\frac{125 - T_a}{125 - T_{std}}}$$

Where,

- T_a = Application ambient temperature
- T_{std} = Standard testing ambient temperature

Example:

Determine the ambient temperature correction factor for a fuse installed at a 55 °C ambient temperature condition?

Per formula, it is calculated to be:

$$F_{AT} = \sqrt{\frac{125 - T_a}{125 - T_{std}}} = \sqrt{\frac{125 - 55}{125 - 25}} = \sqrt{\frac{70}{100}} = \sqrt{0.7}$$

$$F_{AT} = 0.84$$



2b: Forced Cooling: Due to their switching properties, power semiconductor devices typically produce large amounts of heat during normal operating conditions. When the heat produced exceeds their safe operating temperature limits, the devices will become inoperable.

Forced air cooling and liquid cooling are the two heat sinking methods commonly practiced in such applications. Fuses that are used to protect such devices are also subjected to such heat sinking methods and can directly affect (increase) the current carrying capacity of the high-speed fuse.

The curve shown in **Figure 30** determines the Forced (Air) Correction Factor (F_{FC}) to be used when sizing the rated current of a high-speed fuse.

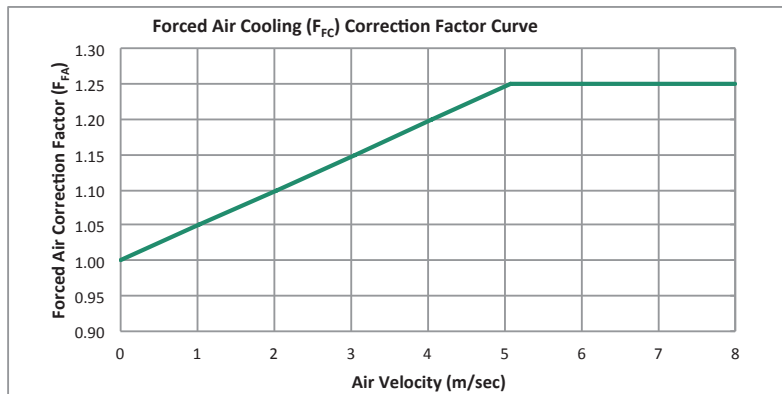

Figure 30. Forced (air) cooling correction factor (F_{FC}) curve

Example:

Determine the forced air cooling correction factor for a fuse installed at an application with an air velocity of 4 m/sec.

Per the forced air correction curve:

An average current density and reference values (100 %)

For an air velocity of 4m/sec, $F_{FC} = 1.20$

For applications with a liquid cooled bus-bar system (which may be used along with forced air cooling), the forced cooling correction factor of $F_{FC} = 1.25$ can be considered when sizing a high-speed fuse’s rated current.

2c: Conductor Size (Wiring Connection Factor): High-speed fuses are connected to a system by means of copper conductors in the form of cable or bus-bar termination. The main purpose of the termination is to conduct power, but they also serve as a heat sinking device to remove heat from the fuse terminals and allowing it to operate efficiently.

Conductor size is critical for alignment between the fuse specification and the wiring/busbar specification. Lack of consideration may lead to nuisance opening of the fuse.



The cross-section size of the conductor significantly impacts the current carrying capacity of a high-speed fuse. The rated current of a high-speed fuse is determined based on testing with recommended conductor sizes outlined in international standards. When applying these fuses in the field, any reduction in conductor size would require appropriate de-rating of the fuse rated current. In other words, fuse current ratings should be determined based on the cross-section size of the conductor.

Per IEC 60269-4 Standard Section 8.3.1, the current density of the copper conductor used shall be between 1.0 A/mm² (minimum) to 1.6 A/mm² (Maximum) and vary with the rated current of the fuse. For ease of calculation, 1.3 A/mm² is considered as the reference value (100 %) for the conductor sizes. Based on this reference value and the application conductor size, the wiring correction factor (F_{WR}) for the application is determined from the curve showing in **Figure 31** and factored in accordingly while sizing the rated current of high-speed fuses.

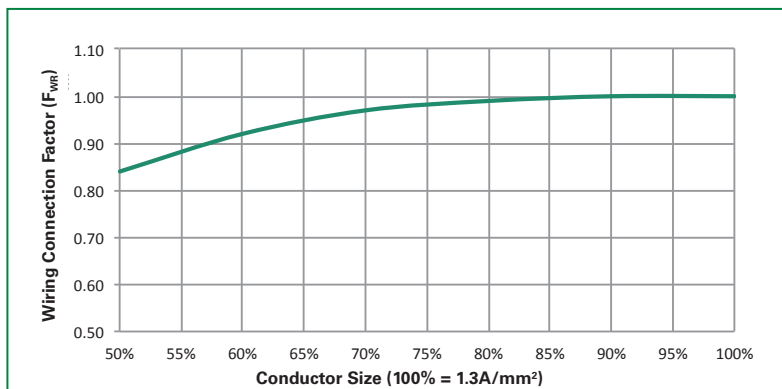

Figure 31. Wiring connection factor (F_{WR}) curve

Example:

Determine the wiring connection factor for an application with a 400 A load current using copper conductor with a cross-section of 185 mm².

Load current: 400 A

Conductor size used in application: 185 mm²

Copper current density per IEC standard: 1.3 A/mm²

Recommended conductor size for 400 A (per IEC standard): $\frac{400 \text{ A}}{1.3 \text{ A/mm}^2} = 308 \text{ mm}^2$

Based on the IEC recommended conductor size determined above, the application conductor size used is about **60 %** of the recommended size.

Applying the 60 % value determined in the wiring connection factor curve, the wiring connection factor for the application is, **$F_{WR} = 0.92$**

2d: Frequency: High-speed fuses have one or more fusible elements connected in a parallel configuration within their fuse body. When these fuses are subjected to high frequencies, and due to the electromagnetic property of AC power, the flow of current through the fuse is constrained to the outer layers of the fusible element, known as skin and proximity effect. This phenomenon causes unbalanced sharing of current between fusible elements resulting in increased heat, which significantly reduces the current carrying capacity of a fuse and could result in premature operation of a fuse.

High frequency affects fuse current rating.



Applications with a frequency above 10 kHz are considered as very high frequency applications and require increased attention when sizing high-speed fuses. Consult Littelfuse Technical Services for such applications.

The curve shown in **Figure 32** determines the frequency correction factor (F_{HZ}) to take into consideration when sizing the high-speed fuse rated current.

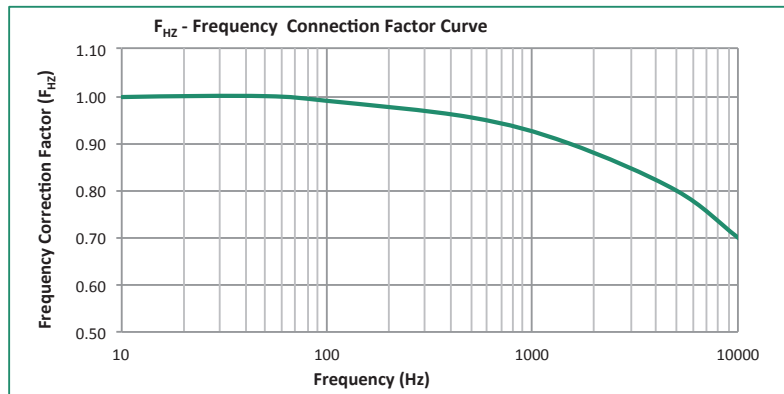

Figure 32. Frequency Correction Factor (F_{HZ}) Curve

Example:

Determine the frequency correction factor for an application with application frequency of 500 Hz.

Application frequency: 500 HZ

From the frequency correction factor curve shown in **Figure 32**, the corresponding frequency correction factor for the application is **$F_{HZ} = 0.96$**

2e: Switching and Surges: In general, all electrical equipment is subjected to start-stop operations. The frequency of start (ON) and stop (OFF) operation and the associated surge in current during switching determines the aging effect on high-speed fuses.

An ON-OFF operation induces heating and cooling effects on fuse elements. The higher the number of switching operations, the greater the impact on the fuse current carrying capacity over a period of time.

The switching correction factor table below provides the recommended switching de-rating factors (F_{SS}) to be considered for any frequent switching applications.

Table 1. Switching Correction Factor (F_{SS}) Table

Switching Correction Factor (F_{SS}) Table	
Frequency of Switching	Switching Correction Factor (F_{SS})
Less than 12 stops per year	1.00
More than one stop per month	0.95
More than two stops per week	0.90
More than one stop per day	0.85
Several stops per day	0.80



2f: Altitude: Increase in altitude above 2000 m mean sea level (MSL) causes reduction in heat dissipation due to convection and radiation within fuse elements.

A general industry practice of 0.5 % de-rating in component current rating for every 100 m above 2000 m mean sea level should be applied while calculating the high-speed fuse rated current.

Altitude correction factor is given by the term $F_{AL} = (1 - ((h - 2000) / 100) * 0.005)$ where 'h' is the application altitude.

Example

What is the altitude correction factor to be used for installation applied at 3500m above sea level?

Application Altitude (h): 3500 m

Altitude Correction Factor Formula:

$$F_{AL} = (1 - ((h - 2000) / 100) * 0.005)$$

$$F_{AL} = (1 - ((3500 - 2000) / 100) * 0.005)$$

$$F_{AL} = (1 - (0.075))$$

$$F_{AL} = 0.925$$

Altitude Correction Factor $F_{AL} = 0.925$

Rated Current of the High-Speed Fuse: In summary, the rated current of a high-speed fuse can be determined using the following formula:

Where,

I_{AL} = Adjusted normal full-load current

I_N = Rated current of high-speed fuse for the application

F_{AT} = Ambient temperature correction factor

F_{FC} = Forced cooling correction factor

F_{WR} = Wiring connection factor

F_{SS} = Switching correction factor

F_{AL} = Altitude correction factor

$$I_N = \frac{I_{AL}}{F_{AT} * F_{FC} * F_{WR} * F_{HZ} * F_{SS} * F_{AL}}$$

Example:

Determine the suitable Littelfuse POWR-SPEED North American round body fuse for a rectifier application with the following system details:

Ac system voltage = 600 V

Frequency = 60 Hz

Ambient temperature (Ta) = 65 °C

Forced air cooling = 3 m/s

Load current = 100 A

Available short-circuit fault current = 35 kA

Load condition = 15 stops per day

Overload condition = 200 % for 10 sec for every 3 minutes

Thyristor I²t withstand rating = 20,000 A²s



Rated Voltage of the Fuse (E_N):

$$E_N = \frac{E}{0.9}$$

$$E_N = \frac{600}{0.9}$$

$$E_N = 667 \text{ V} \sim 700 \text{ V ac}$$

Load Current:

$$I_{AL} = \sqrt{\frac{I_1^2 t_1 + I_2^2 t_2}{T}}$$

$$= \sqrt{\frac{(100^2 * 180) + (200^2 * 10)}{190}}$$

$$I_{AL} = 107.6$$

Ambient Temperature Correction Factor:

$$F_{AT} = \sqrt{\frac{125 - 65}{125 - 25}}$$

$$F_{AT} = 0.775$$

Forced Cooling Correction Factor

Forced Air Cooling: 3 m/s
 Based on Forced Cooling Correction Factor Graph,
 $F_{FC} = 1.15$

Switching Correction Factor

Number of Stops per Day: 15
 Based on Switching Correction Factor Table
 $F_{SS} = 0.8$

Rated current of the fuse (I_N)

$$I_N = \frac{I_{AL}}{F_{AT} * F_{FC} * F_{SS}}$$

$$I_N = \frac{107.6}{0.775 * 1.15 * 0.8}$$

$$I_N = \frac{107.6}{0.713}$$

$$I_N = 150.9 \sim 150A$$

Upon calculating the rated current including all of the factors involved, POWR-SPEED fuse part number L70QS150.V rated for 150 A, 700 V ac/dc, and 200 kA I.R. could be considered for this application. This fuse has a total clearing I^2t value of 13,650 A²s at 700 V ac which, is less than the thyristor device withstand rating of 20,000 A²s, and meets the voltage and current rating requirements of the application and thus can be recommended.



4.3 Interrupting Rating

Interrupting rating is defined as the RMS maximum fault current a fuse can clear without any visible deformity. Interrupting rating for high-speed fuses and other industrial fuses are typically expressed in kiloampere (kA).

Interrupting Rating of Fuse Selected > Available Fault Current

Interrupting rating of the fuse selected should be greater than the application's available fault current to provide adequate protection.

4.4 Total Clearing I²t Value (Withstand Energy)

Total clearing I²t value is the maximum let-through energy when tested at rated voltage (published in datasheet table). Total clearing I²t value for a reduced application voltage can be found using total clearing I²t correction factor chart (refer to Section 3.8.3).

Total clearing I²t value < Semiconductor Device Fusing I²t Value

Total clearing I²t value of the fuse should be less than the semiconductor device's withstand rating or fusing I²t value (expressed in A²s).

4.5 Peak Arc-Voltage

Voltage that appears across the fuse element during its operation is referred as arc-voltage. It is higher than the fuse rated voltage (about twice). Peak arc-voltage for a fuse, appears when tested at its rated voltage. To calculate the arc-voltage for a fuse for voltage ratings lesser than its rated voltage – Use the peak arc-voltage correction factor chart in datasheet (Refer to Section 3.8.4.).

Fuse Peak Arc-Voltage < Semiconductor Peak Inverse Voltage (PIV)

Peak arc-voltage calculated should be less than the peak inverse voltage (PIV) of the semiconductor device used.



5.0 APPLICATION CONSIDERATIONS

5.1 Protection of Power Conversion Devices

A typical application of high-speed fuses in a general industrial environment would involve the protection of power conversion equipment used in motor control systems (such as drives and soft-starters), power supplies and heating applications.

Figure 33 represents a typical circuit of a three-phase power converter circuit. There are three basic building blocks in this circuit: the input converter (also known as the rectifier), the filter and dc connection (also known as dc common bus), and the output inverter (or inverter).

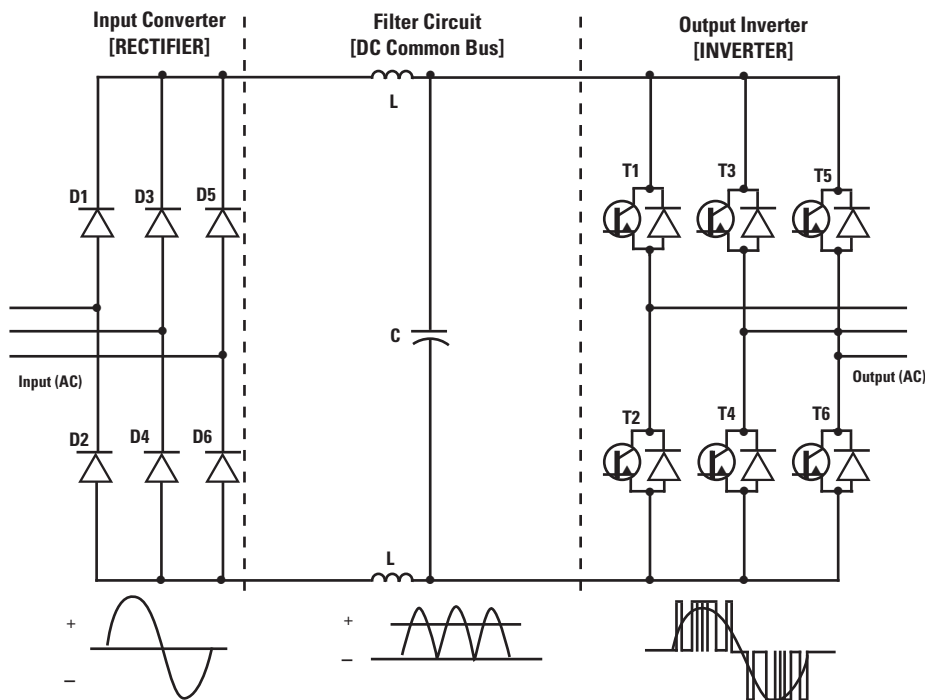

Figure 33. Typical three phase power converter circuit

Protection requirements vary at each location, however the main purpose of the fuses in this circuit are to continuously allow the nominal load current and any permissible overload current to continue without any interruption. At the same time, the fuses are selected to interrupt any overcurrent fault caused during overload or short-circuit, with minimal let-through energy in order to protect the power semiconductor devices connected in the circuit.

5.1.1 Protection Consideration for Rectifier Circuits

Power semiconductor diodes are typically used for design of rectifier circuits, with the main purpose of this circuit being the conversion of ac to dc by allowing current to flow in only one direction. Rectifier circuits are found in a wide variety of applications, from small power supplier to large high-voltage dc power transmission systems.

The location of a high-speed fuse in a rectifier circuit depends on the size of the system when considering power rating. **Figure 34** illustrates the typical location of high-speed fuses in a rectifier circuit.

For smaller power rated devices, high-speed fuses are typically found only on the ac line side in a one fuse per phase arrangement.



For larger power systems, high-speed fuses are typically located both on the ac line side, as well as individually in series with each power semiconductor device on each arm of the rectifier circuit.

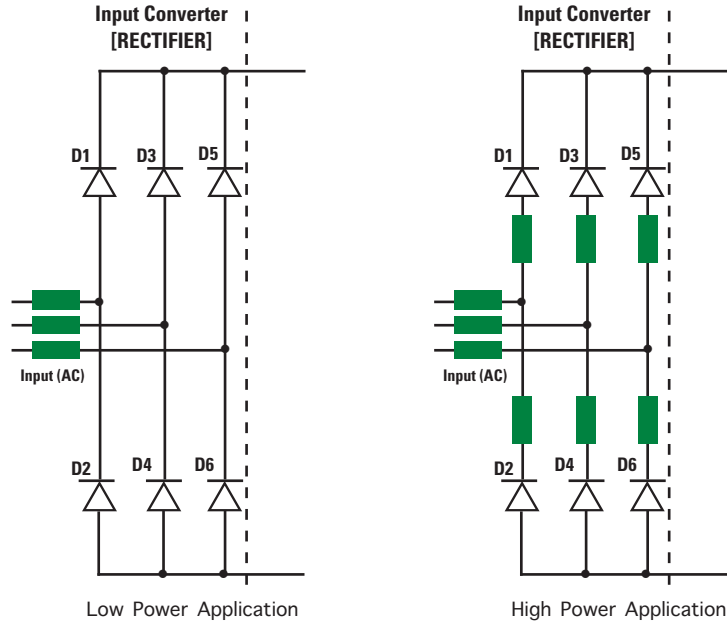

Figure 34. Location of high-speed fuses in rectifiers

5.1.2 Protection Consideration for Inverter Circuits

Power transistors (IGBTs and MOSFETs) are typically used for the design of inverter circuits. These transistor devices are turned ON and OFF using gate pulses from the driver circuits to produce the required ac waveform from the dc source. Inverter circuits have a wide range of applications and can be found in electric motor adjustable speed drives, uninterruptable power supplies (UPS), battery management systems, flexible ac transmission systems (FACTS), and many more.

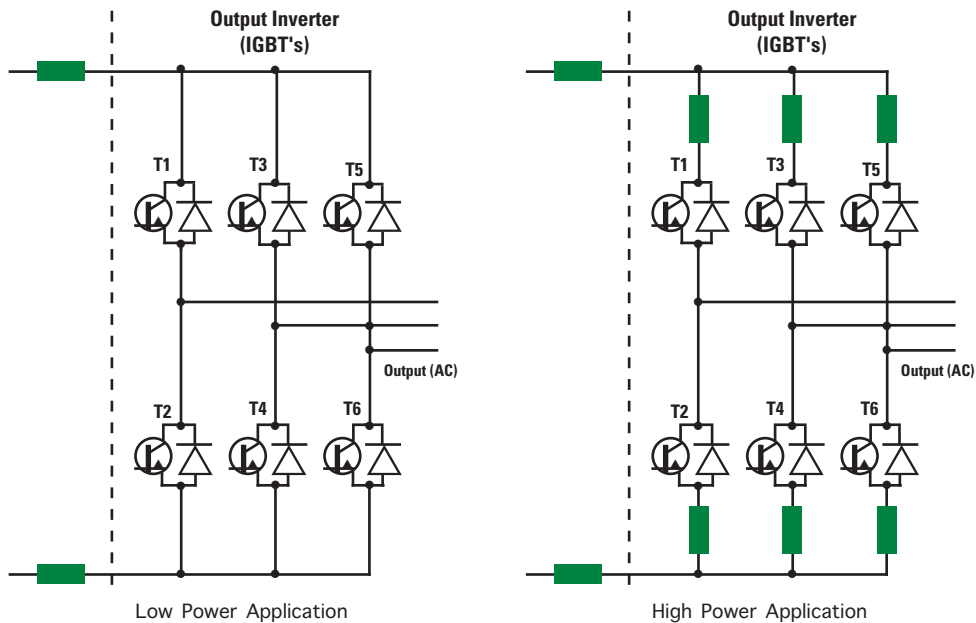

Figure 35. Location of high-speed fuses in inverters



High-speed fuses are used in inverter circuits to prevent line-to-line short circuit fault conditions. There are multiple ways this fault could be generated, with the misfiring of transistors being one of the leading causes. Depending on the power rating of the inverter circuit, the location and number of high-speed fuses used in the circuit varies. For low power applications, the high-speed fuses are typically designed only on the dc bus (one each on positive and negative). For higher power inverter circuits, fuse can be used both on the dc bus side and individually nearer (in series) to each transistor.

5.1.3 Protection Consideration for DC Bus

Depending on the application, requirements for the protection of the dc common bus, also known as dc bus, varies. DC bus configurations are generally found in group motor application (**Figure 36**), where multiple adjustable speed drives are fed from a dc common bus. This configuration offers the most efficient way to operate multiple motors in processing industries. A typical fault condition that could occur in this configuration would be a line-to-line dc short-circuit fault which would require high-speed fuse protection on both the positive and negative buses of the dc line to protect the drives connected to the dc bus.

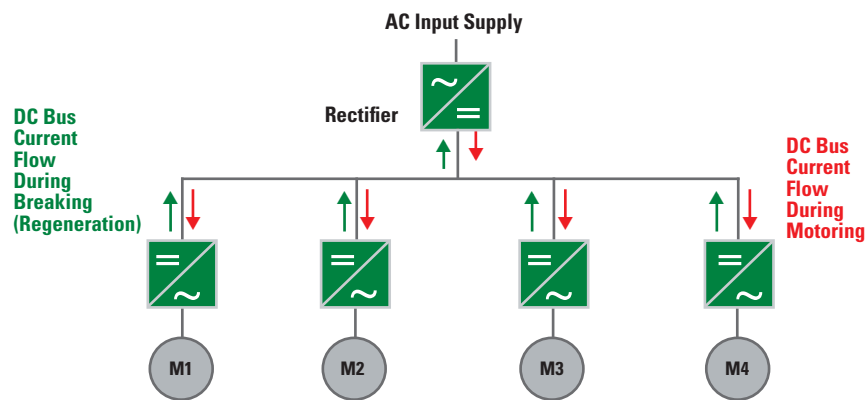

Figure 36. Dc bus configuration

Protection of the dc bus is also required in standalone dc drives and common power conversion circuits nearer to the filter circuits that might be susceptible to insulation failure causing a line-to-line dc short-circuit fault condition. High-speed fusing on both positive and negative bus is recommended in this application.

In general, while protecting the dc bus, high-speed fuses that are specially designed and tested to dc voltages with a dc time constant (L/R value) higher than the application specifications, are the right choice to offer the best level of protection. It is not recommended to use ac high-speed fuses while protecting the dc bus.

5.2 Protection for UL Motor Branch Circuits

There is a general perception that only UL Listed fuses (current limiting and with the proper rejection features) could be used for branch circuit protection per the NEC and general industrial practices. However, the NEC does permit the use of high-speed fuses for motor branch circuit protection under certain conditions.

NEC Article 430.52(C)(5) outlines the use of high-speed fuses for motor branch circuit protection in motor control systems that use solid-state devices such as drives and soft-starters.

Per the NEC, when the motor device is protected with built-in overload protection or overload protection is offered by a separate device connected in the same circuit, high-speed fuses can be used for branch circuit protection. A typical example would be larger motor circuits using variable frequency drives or other power conversion devices where overload protection is built-in to the drives. Intended to prevent any misapplications, on condition imposed by the NEC for users looking to utilize this exception/part of the code is the requirement to provide markings for high-speed fuse replacement (such as part number, make, etc.) adjacent to these fuse installations.



Due to the wide variety of shapes and sizes offered, high-speed fuses can only be UL Recognized to the UL 248-13 standard and cannot be UL Listed.

5.3 Protection of IGBT Based Devices

To achieve quality power output, high frequency devices such as IGBTs are typically used on the low inductance (or inverter) side of a power conversion circuit. Switching losses are prevalent in such circuits and designing them with minimal losses is a challenging task for engineers. Components used in these circuits including capacitors, bus-bar, and fuses are designed with the inductance as low as possible.

In general, IGBT modules cannot be protected from short-circuit faults using high-speed fuses, whereas diodes and thyristors can be protected. The reason behind this is that IGBT modules available today can detect and turn off during a short-circuit instantly by means of specially designed driver circuits designed to function in micro (μ) seconds.

However, if the driver circuit fails to turn off the IGBT during a short-circuit fault condition, or if the internal conductors (thin aluminum wires) connected to the IGBT melt during a fault condition, there is a considerable rise in current and voltage. This leads to a melting and arcing situation inside the IGBT modules, which results in vaporization of silicon material, likely causing a catastrophic case rupture failure.

High-speed fuses, when used in conjunction with IGBT devices, prevent such catastrophic events during a fault condition. High-speed fuses can sense and operate during a short-circuit fault within a few milliseconds. By creating a complete open-circuit condition during its operation, high-speed fuses limit any further flow of high currents into the IGBT module which prevents case-rupture.

Limited ranges of specially-designed IGBT fuses are available in the market today offering low inductance in high-frequency applications. These devices have a special design element profile that offers equal distribution of current between them, thereby offering minimal inverse proximity effect impact and better thermal profile. However, such special design IGBT fuses also do not protect the IGBT module, as they are designed to prevent case-rupture during a fault condition.

Properly sizing a standard high-speed fuse to the application requirements could provide adequate protection to IGBT based device applications.

5.4 High-Speed Fuses Connected in Parallel

The need for high current application results in requirements for larger and bulkier high-speed fuses. In most cases, the availability of such larger fuses is limited, hence paralleling of one or more standard size high-speed fuses is widely practiced in the industry.

Paralleling of fuses has its own benefits and challenges¹. Some of the benefits include:

- Protection of high current and low withstand rating applications, where a single large fuse is not available to meet the requirement
- Maximizing heat dissipation and minimizing watt loss in power electronics applications
- Better inventory management for original equipment manufacturers (OEMs), distributors, and end-users

Challenges faced while paralleling fuses include:

- Estimating the combined performance of fuses when connected in parallel
- Selection of correct fuse combination for paralleling, depending on the load and application conditions
- Adapting the correct paralleling techniques to prevent misapplication

*Reference:

¹ B. Gradwell, "Arc flash mitigation through the use of an engineered parallel high speed semi-conductor fuse assembly," IEEE/IAS 50th Industrial and Commercial Power Systems Technical Conf., Fort Worth, TX, USA, May 20–23, 2014, doi: 10.1109/ICPS.2014.6839162.



NEC Article 240.8 only allows fuses and circuit breakers to be connected in parallel if they are factory assembled in parallel and listed as a unit. T

The first step in the proper paralleling of fuses starts with the selection of the correct fuse combination. The best practice followed in industry is to choose fuses with the same specifications for paralleling (i.e. same ampere rating, voltage rating, size, style, etc.); in other words, using the same part number. Additionally, only fuses with approximately similar resistance values should be selected for paralleling in the field.

Note: The performance of the fuse varies based on system conditions, so application testing is strongly recommended.

Design Considerations: Application factors that design engineers should take into consideration while paralleling fuses include:

1. Estimation of theoretical (electrical and thermal) performance of parallel fuses
2. Validation of application conditions for proper sizing of parallel fuses
3. Selection of proper mounting arrangement and accessories to meet application requirements

5.4.1 Estimation of Theoretical Performance

Nominal Current Rating (I_{np}): When two or more fuses are considered for paralleling, the combined ampere rating of the paralleled fuses is always less than the numerical sum of individual fuse ampere ratings. The reduction in current carrying capacity is due to increased ambient thermal condition when fuses are placed near each other, and often there is unequal current distribution in paralleled fuses.

It is recommended that a de-rating factor (K_p) should be applied while estimating the nominal current rating of a paralleled fuse.

When two to four fuses are connected in parallel: **$K_p = 0.9$**

When more than four fuses are connected in parallel: **$K_p = 0.8$**

The nominal current rating for a paralleled fuse (I_{np}) is determined by the formula:

$$I_{np} = (I_1 + I_2 + \dots + I_n) * K_p$$

Example:

What is the estimated nominal current rating when two 100A fuses are connected in parallel?

$$I_1 = 100A$$

$$I_2 = 100A$$

$$K_p = 0.9 \text{ (two fuses)}$$

$$I_n = (100+100) * 0.9 = 180A$$

Nominal Voltage Rating (V_{np}): The nominal (or combined) voltage rating for paralleled fuses is equal to the individual voltage rating of any one of the fuses in the combination.

Time-Current Characteristic (TCC): For fuses that are connected in parallel, it is challenging to publish TCC curves, as it varies with the number of fuses connected and various other application conditions. It is recommended to use the formula below for estimating the combined TCC curve (TCC_{np}) for fuses when connected in parallel.

$$TCC_{np} = TCC_1 * N * K_p$$



Where:

TCC_1 = TCC curve of any fuse on the combination

N = Number of parallel fuses connected

K_p = Paralleling fuse de-rating factor

This formula can be applied by keeping the time axis constant and plotting the change in current values, for the specific fuse that is considered for paralleling.

Peak Let-Through Current: Peak let-through charts for parallel fuses are typically not available in the datasheet, unless it is factory assembled. It is recommended to use the formula below to estimate the peak let-through values for fuses connected in parallel (I_{N-PEAK}).

$$I_{N-PEAK} = I_{p1} * N^{2/3}$$

Where:

I_{p1} = Individual fuse peak let-through current

N = Number of parallel fuses connected

Ampere-Squared-Seconds (I_2t Value): I_2t values for a fuse when tested at its rated voltage and when interrupting the circuit are published in the fuse's datasheet. When two or more fuses are connected in parallel, the combined I^2t_{np} value is determined by the formula:

$$I^2t_{np} = I^2t_1 * N^2$$

Where:

I^2t_1 = Individual fuse I^2t value

N = Number of parallel fuses connected

5.4.2 Validation of Application Conditions for Proper Sizing

The understanding of the application's conditions is critical while properly sizing fuses. The performance of the fuse is greatly affected by an application's system parameters. The following typical application conditions should be considered when sizing high-speed fuses:

- Ambient temperature
- Forced cooling
- Conductor type and size
- Load conditions
- Available fault current
- Withstand rating (I^2t) of semiconductor device
- Peak inverse voltage
- Frequency or time constant
- Vibration and shock



5.4.3 Selection of Proper Mounting, Arrangement, and Accessories

High-speed fuses are available in different shapes, sizes, and terminations, so selecting the proper style is critical when paralleling fuses. For reliable performance, the use of identical part numbers is recommended when paralleling.

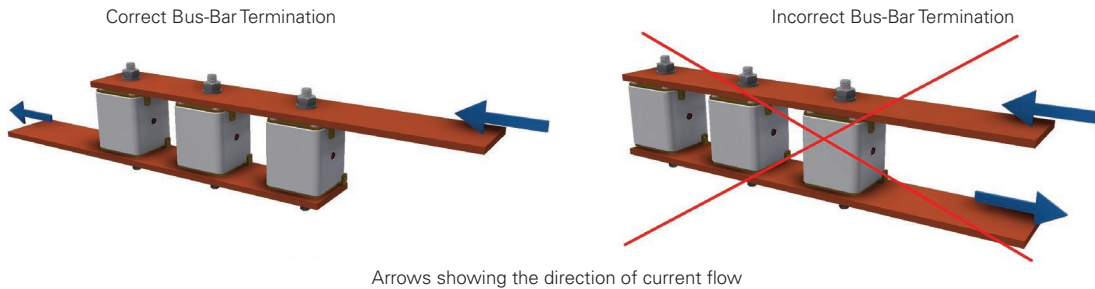

Figure 37. Paralleling two or more high-speed fuses

High-speed fuses run considerably hotter when compared to other fuses, so the distance between the fuses is critical when paralleling fuses. It is recommended to maintain 10 mm to 25 mm of spacing between two fuses connected in parallel. Also, when using high-speed fuses in parallel, bus-bar mounting is widely preferred to reduce mechanical stresses on the internal fuse elements.

Placement of bus-bar and direction of current flow is a critical factor while paralleling high-speed fuses. **Figure 37** illustrates the recommended arrangement for fuses connected in parallel in a bus-bar connection.

Fuses should be connected to the bus-bar such that the incoming current and outgoing current are not in opposite directions. When fuses are connected in an anti-parallel configuration (bus-bars are in parallel, but the currents are moving in opposite directions) additional bus-bar resistance ends up being added to the outermost fuse. It might also bend the bus-bar due to the sizable magnetic forces involved.

Using the proper stud size and applying the recommended tightening torque would ensure proper termination and help prevent any nuisance operations. Refer to the product’s datasheet for stud size and torque recommendations.

Littelfuse high-speed square body style fuses feature visual indication on them to represent the state of each fuse. An external indicator switch (microswitch) for alarm signaling can be used on any one or more parallel fuses to represent the state of the parallel fuses.

5.5 High-Speed Fuses Connected in Series

Series connection of two high-speed fuses is generally not recommended. However, in power converter circuits that are designed to handle high-power levels (for example: a rectifier circuit using multiple power semiconductor devices per arm/leg), high-speed fuses could be designed in a series configuration. In such situations, the voltage ratings of the fuses selected should be equal to the system voltage rating. In addition, to prevent nuisance operation, the total clearing I^2t value of the line side fuse should be less than the sum pre-arcing I^2t for all individual arm/leg fuses.

$$\text{Total Clearing } I^2t \text{ Line Fuse} < \text{Sum of Pre-arcing } I^2t \text{ of Leg or Arm Fuse}$$



6.0 INSTALLATION GUIDELINES

The proper installation of high-speed fuses is critical when designing circuit protection for power semiconductor devices. Thermal imbalance caused by the inadequate installation and maintenance of high-speed connections is the main reason there are nuisance operations in the field. The best practices for high-speed fuse installation are discussed briefly in this guide.

Conductor: Copper conductors are generally preferred for connecting with high-speed fuses. These connectors could be found in the cable or in bus-bar construction. Proper spacing between the connectors (meeting the requirements of the local electrical code adopted) is also recommended.

Termination/Connection: Use the screw type and size mentioned in the fuse’s datasheet.

For the PSR series square body flush mount fuses, use a stud and nut assembly instead of a bolted termination, which will prevent damage to the internal fuse elements.

For the PSR series square body bolt down fuses, use a bolted termination of the appropriate size.

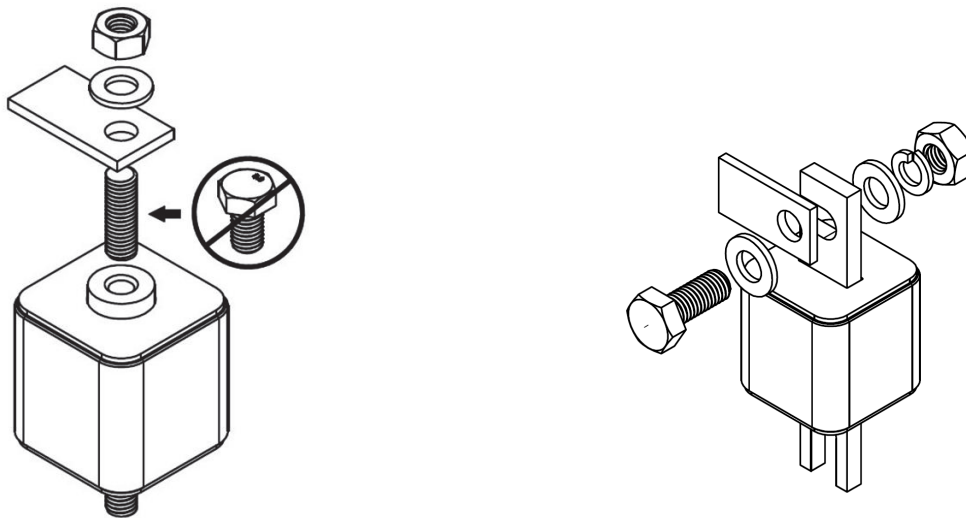

Figure 38. Recommended means for fuse termination



Tightening Torque: It is recommended to use the tightening torque values listed in the fuse and fuse holder datasheets. When applying the tightening torque and any counteracting forces, a general suggested practice as shown in **Figure 39** could help ensure proper fuse termination.

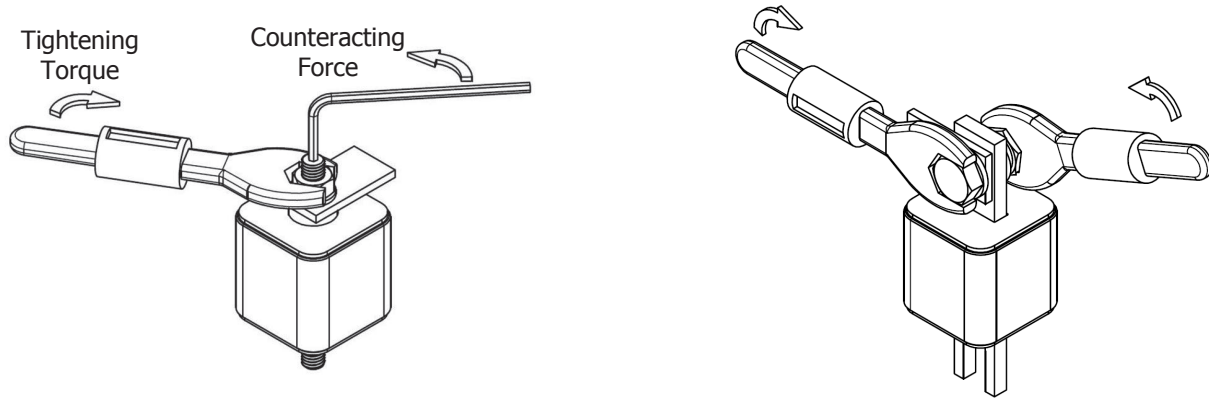

Figure 39. Recommended means to establish connection

Mounting Alignment: Proper care should be taken during the tightening process to avoid any air gaps between the bus-bar and the fuse terminals. Such an air gap could lead to misalignment, which could cause potential thermal stress or arcing issues.

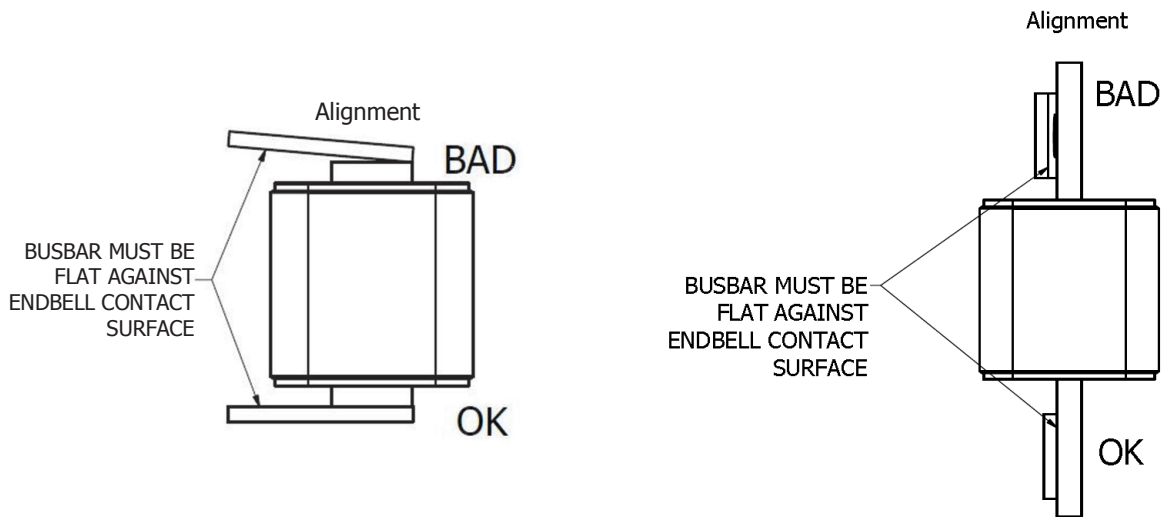

















Figure 40. Recommended fuse mounting alignment



7.0 POWR-SPEED RANGE & SELECTION GUIDE

SERIES NAME	AMPERAGE	OPERATING AC VOLTAGE	OPERATING DC VOLTAGE	AC AND DC INTERRUPTING RANGE	AGENCY APPROVALS	APPLICATIONS												
						POWER CONVERTERS	HIGH POWER INVERTERS	HIGH-POWER RECTIFIERS	DC BUS	POWER SUPPLIES	BATTERY MANAGEMENT SYSTEMS	UPS	AC/DC DRIVERS	VFDs	HEATERS			
 <p>PSR</p>	40–2000 A	550-1300 V ac	480-1000 V dc	Ac: 100 kA–200 kA Dc: 150 kA		•	•	•	•	•	•	•	•	•	•	•	•	•
 <p>L70QS</p>	35–800 A	700 V ac	700 V dc	Ac: 200 kA Dc: 50 kA		•				•	•	•	•	•	•	•	•	•
 <p>L50QS</p>	35–800 A	500 V ac	500 V dc	Ac: 200 kA Dc: 50 kA		•				•	•	•	•	•	•	•	•	•
 <p>L70S</p>	10–800 A	700 V ac	650 V dc	Ac: 200 kA Dc: 20 kA		•				•								•
 <p>L50S</p>	10–800 A	500 V ac	450 V dc	Ac: 200 kA Dc: 20 kA		•				•								•
 <p>L60S & KLC</p>	1–800 A	600 V ac	N/A	Ac: 200 kA		•				•								•
 <p>L25S</p>	1–800 A	250 V	200 V dc–250 V dc*	Ac: 200 kA Dc: 20 kA		•				•	•			•				•
 <p>L15S</p>	1–1000 A	150 V	100 V dc–150 V dc	Ac: 100 kA Dc: 20 kA		•				•	•							•

8.0 ACCESSORIES

8.1 Microswitches

The Littelfuse MS series microswitches offer remote indication features for the PSR series square body fuses. These microswitches are three terminal devices (NO, NC, and C) with the contact terminals being silver plated. The minimum operating voltage and current for these switches are 4 V and 1 mA. In addition to electrical contacts, these microswitches have a red flap for visual indication of the fuse's status.

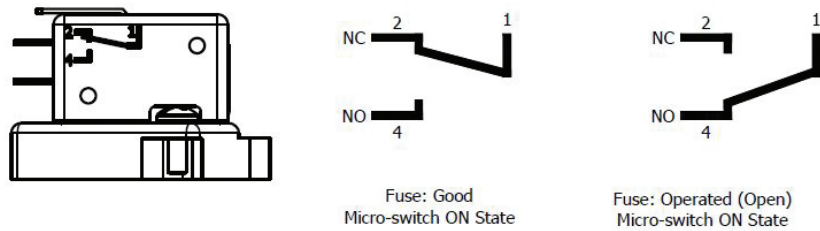

Figure 41. Circuit of MS Microswitch with NO-NC Contact

These microswitches can be connected directly to the fuse terminals using standard screws. The terminal C contact in the microswitch is actuated upon the fuse blowing through a spring-loaded indication mechanism on the fuse body. This change in state of indication is permanent, and could be reset only by a manual reset operation of the red flap on the microswitches.



Figure 42. MS series microswitch for PSR series fuses

MS series microswitches are available for all PSR series square body case sizes.

- Microswitch part number MS3H1000C is suitable for use with case sizes 30, 31, 32, and 33
- Microswitch part number MS7H1500C is suitable for use with case sizes 70, 71, 72, and 73

The operating temperature range for these microswitches is between -60 °C to +125 °C at a relative humidity of 95 %. For more information on these microswitches, refer to the product datasheet.



8.2 Stud Blocks

The use of stud mounting is widely adopted for North American style round-body fuse (namely Littelfuse L70QS, L50QS, L25S series fuses). Littelfuse LSCR series stud blocks should be used for such requirements. Stud blocks get directly mounted to the panel board or equipment base plate, and wires are terminated to the screw on each end of the stud blocks.



Figure 43. LSCR series stud blocks

Littelfuse LSCR series blocks are available in both the 700 V and 1000 V range. The block selection guide table found on the LSCR series datasheet should be followed to select the suitable LSCR part number based on fuse series and ampere rating. The recommended tightening torque mentioned in the datasheet is always preferred when mounting high-speed fuses to these stud blocks.



9.0 TERMS & DEFINITIONS

Ampacity – The current in amperes that a conductor can carry continuously under the conditions of use, without exceeding its temperature rating. It is sometimes informally applied to switches or other devices. These are more properly referred to by their ampere rating.

Ampere Rating – The current rating, in amperes, that is marked on fuses or other equipment.

Ampere-Squared-Seconds (I²t) – A means of describing the thermal energy generated by current flow. When a fuse is interrupting a current within its current-limiting range, the term is usually expressed as melting, arcing, or total clearing I²t.

Arcing Fault – A short-circuit that arcs at the point of fault. The arc impedance (resistance) tends to reduce the short-circuit current. Arcing faults may turn into bolted faults by welding of the faulted components. Arcing faults may be phase-to-phase or phase-to-ground.

Arcing I²t – Heat energy passed by a fuse during its arcing time. It is equal to the rms arcing current squared, multiplied by arcing time.

Arcing Time – The time between the melting of a fuse link, until the overcurrent is interrupted (See **Figure 13**).

Arc Voltage – Arc voltage is a transient voltage that occurs across an overcurrent protection device during the arcing time. It is usually expressed as peak instantaneous voltage (V_{PEAK} or E_{PEAK}), rarely as rms voltage.

Bolted Fault – A short-circuit that has no electrical resistance at the point of the fault. It results from a firm mechanical connection between two conductors, or a conductor and ground. Bolted faults are characterized by a lack of arcing. Examples of bolted faults are a heavy wrench lying across two bare bus bars, or a crossed-phase condition due to incorrect wiring.

Clearing (I²t) (also Total Clearing I²t) – The I²t through an overcurrent device from the inception of the overcurrent until the current is completely interrupted. Clearing I²t is the sum of the melting I²t and the arcing I²t.

Clearing Time – The time between the initiation of an overcurrent condition to the point at which the overcurrent is interrupted. Clearing time is the sum of melting time and arcing time.

Continuous Current – An electrical load where the maximum current is expected to continue for three hours or more.

Current Limitation (Fuse) – A fuse which, when interrupting currents within its current-limiting range, reduces the current in the faulted circuit to a magnitude substantially less than that obtainable in the same circuit if the device was replaced with a solid conductor having comparable impedance.

Current Limiting Range – For an individual overcurrent protective device, the current-limiting range begins at the lowest value of rms symmetrical current at which the device becomes current-limiting (the threshold current) and extends to the maximum interrupting capacity of the device.

Ground Fault – Unintentional contact between a phase conductor and ground or equipment frame. The words “ground” and “earth” are used interchangeably when it comes to electrical applications.

Inductive Load – An inductive load is typically a motor load in which current waveform is lagging the voltage waveform. An inductive load pulls a large amount of current (an inrush current) when first energized. After a few cycles or seconds the current settles down to the full-load running current.

Interrupting Capacity (AIC) – The highest available symmetrical rms alternating current (for dc fuses the highest direct current) at which the protective device has been tested, and which it has interrupted safely under standardized test conditions. The device must interrupt all available overcurrents up to its interrupting capacity. Also, commonly called interrupting rating.

Interrupting Rating (IR, I.R., AIR or A.I.R.) – The highest rms symmetrical current, at specified test conditions, which the device is rated to interrupt. The difference between interrupting capacity and interrupting rating is in the test circuits used to establish the ratings.

Melting I²t – The heat energy passed by a fuse after an overcurrent occurs and until the fuse link melts. It equals the rms current squared multiplied by melting time in seconds. For times less than 0.004 seconds, melting I²t approaches a constant value for a given fuse.



Melting Time – The time span from the initiation of an overcurrent condition to the instant arcing begins inside the fuse.

Overcurrent – Any current larger than the equipment, conductor, or devices are rated to carry under specified conditions.

Overload – An overcurrent that is confined to the normal current path (e.g., not a short-circuit), which if allowed to persist, will cause damage to equipment and/or wiring.

Peak Let-Through Current – The maximum instantaneous current that passes through an overcurrent protective device during its total clearing time when the available current is within its current-limiting range.

Power Factor – The ratio of the actual electrical power dissipated by an ac circuit expressed in kilowatt (KW) to the product of the rms values of current and voltage, and expressed as apparent power (kVA). The difference between the two is caused by reactance in the circuit and represents power that does no useful work.

Recovery Voltage – Voltage measured across the fuse terminals after its operation.

Resistive Load – A resistive load, or resistive load bank, is a non-motor load in which current waveform is in phase with its voltage waveform. They are commonly used as heat generators.

RMS (Root Mean Squared) Current – Effective current value for a given ac wave obtained through mathematical method. The rms value of ac is equivalent to the value of dc which, would produce the same amount of heat or power. The mathematical expression of rms current corresponds to the peak instantaneous value of a ac waveform divided by the square root of two.

Semiconductor Fuse – A fuse specifically designed to protect power semiconductor devices such as silicon rectifiers, silicon-controlled rectifiers, thyristors, transistors, and similar components.

Short-Circuit – A current flowing outside its normal path. It is caused by a breakdown of insulation or by faulty equipment connections. In a short-circuit, current bypasses the normal load. Current is determined by the system impedance (ac resistance) rather than the load impedance.

Threshold Current – The minimum current for a given fuse size and type at which the fuse becomes current-limiting. It is the lowest value of available rms symmetrical current that will cause the device to begin opening within the first ¼ cycle (90 electrical degrees) and completely clear the circuit within ½ cycle (180 electrical degrees). The approximate threshold current can be determined from the fuse's peak let-through charts.

Time Constant – The inductance in a dc circuit limits the rate of current rise. The time required for the current to reach 63% of the final value at rated voltage is called the time constant, and is often referred to in terms of L/R where L is inductance in Henrys and R is resistance in ohms.

Virtual Pre-Arcing Time – The term virtual pre-arching was introduced some years ago to help overcome the difficulties in relating the terminology used in the non-current limiting phase (less than 0.01 sec) to that applicable in the current limiting phase (>0.01 Sec). Virtual pre-arching time is expressed as a mathematical ratio of melting energy (in A²s) to the square of rms prospective current.

Voltage Rating – The maximum rms ac voltage and/or the maximum dc voltage at which the fuse is designed to operate. For example, fuses rated 600 V and below may be applied at any voltage less than this rating.

Note: There is no rule for applying ac fuses in dc circuits. Fuses used in dc circuits must have dc ratings.

Withstand Rating – Maximum current an unprotected electrical component can sustain for a specified period without any significant damage to its normal operation.



DISCLAIMER

The purpose of this Technical Applications Guide is to promote a better understanding of high-speed fuses, power semiconductor devices and their common application details within circuit design. These high-speed fuses being considered are current sensitive devices designed to serve as the intentional weak link in the electrical circuit. Their function is to provide protection of power semiconductor components, or of complete circuits, by reliably operating under current overload conditions.

Application guidelines and product data mentioned in this guide is intended for technical reference only. Fuse parameters and application concepts should be well understood to properly select a fuse for a given application. Application testing is strongly recommended and should be used to verify fuse performance in the circuit/application.

Littelfuse products are not designed for, and shall not be used for, any purpose (including, without limitation, automotive, military, aerospace, medical, life-saving, life-sustaining or nuclear facility applications, devices intended for surgical implant into the body, or any other application in which the failure or lack of desired operation of the product may result in personal injury, death, or property damage) other than those expressly set forth in applicable Littelfuse product documentation. Warranties granted by Littelfuse shall be deemed void for products used for any purpose not expressly set forth in applicable Littelfuse documentation. Littelfuse shall not be liable for any claims or damages arising out of products used in applications not expressly intended by Littelfuse as set forth in applicable Littelfuse documentation. The sale and use of Littelfuse products is subject to Littelfuse Terms and Conditions of Sale, unless otherwise agreed by Littelfuse.

For more information visit [Littelfuse.com/Product-Disclaimer](https://www.littelfuse.com/Product-Disclaimer)

Littelfuse reserves the right to make changes in product design, processes, manufacturing location and literature information without notice. For additional questions, contact Littelfuse Technical Services Group at 1-800-TEC-FUSE or techline@littelfuse.com.



FOR MORE INFORMATION, VISIT
[LITTELFUSE.COM/POWR-SPEED](https://www.littelfuse.com/powr-speed)

