

# MANUAL DC BATTERY DISCONNECT SWITCH GUIDE & MARKET OUTLOOK

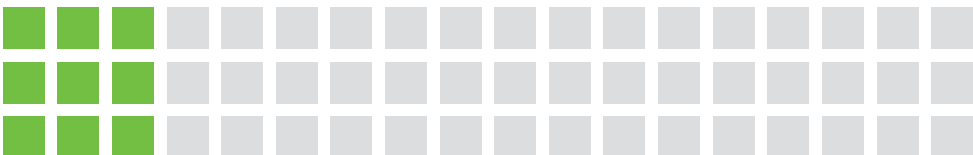

WHITE PAPER





## WHAT'S INSIDE:

- Application and Advantages of a Manual Battery Disconnect Switch
- How to Choose a Manual Disconnect Switch
- The Littelfuse Battery Disconnect Portfolio
- A Brief Look at the Current and Future Manual Disconnect Switch Market

## INTRODUCTION

A manual battery disconnect switch, battery cutoff switch, or isolation switch is mandatory for many kinds of commercial vehicles. It plays a crucial role in protecting the primary function of the vehicle. The main purpose of a battery disconnect switch is to disconnect the battery from the entire electrical system in the vehicle. This is common when a piece of equipment is undergoing service, or during an extended period of storage, protecting against battery drain, removing all parasitic loads and small leakage currents that weaken a battery over time.

Generally, in vehicles, there are some loads (electronic, service lamp, etc.) that are connected to the battery and become the cause of excessive battery drain. Such battery drain is especially evident if the vehicle has been in standing mode for a long period of time. Battery drain also happens when the ignition switch is in the off position, but the electronics of the vehicle are still functioning.

Littelfuse has a comprehensive range of manual disconnect switches, offering varied solutions to users for their battery disconnect requirements. Littelfuse has a wealth of knowledge and expertise to design and manufacture the right battery disconnect switches based on application requirements. This guide covers the advantages of manual disconnect switches, the selection criteria to help you choose the right switch for your application, and how vehicle advancements are driving the market for new, advanced products.



## APPLICATION AND ADVANTAGES OF A MANUAL BATTERY DISCONNECT SWITCH

Utilizing battery disconnect switches, designers have many safety, security, and cost-saving benefits.

### SAFETY

In a commercial vehicle accident, damaged wires and exposed fluids or materials can cause a thermal event and great damage to the vehicle, operators, responders, attached equipment, and nearby structures. Battery disconnect switches prevent further damage by disconnecting the vehicle battery from the electrical system.



### SECURITY

Operators can ensure the vehicle electrical system is shut down by utilizing lockout or tagout measures on the battery disconnect switch, which can be either built-in or accessory lockout. A lockout feature is a physical design that allows the operator to place a padlock on the switch which prevents the switch handle or lever from physically being activated. Thus, the battery disconnect switch remains in the OFF position. A lockout feature also provides additional security against non-operators trying to operate the vehicle.



### COSTS SAVINGS

Parasitic loads or loads that consume power even when the vehicle is shut off, can drain a battery if the vehicle or equipment is stored for long periods of time. By disconnecting the battery, the electrical system will not have any parasitic loads that can drain the battery and cause premature failure. Using a battery switch can help prevent costly battery replacements and ensure that the battery is fully charged for operations.



## PRINCIPLES OF OPERATION AND SELECTION CRITERIA FOR MANUAL BATTERY DISCONNECT SWITCHES

### INSTALLATION AND OPERATION

Battery disconnects are installed in an electrical system between the battery and loads. The switch should be placed as close to the battery as possible while providing the operator with easy access to the actuator so they can quickly and completely power down the vehicle or equipment.

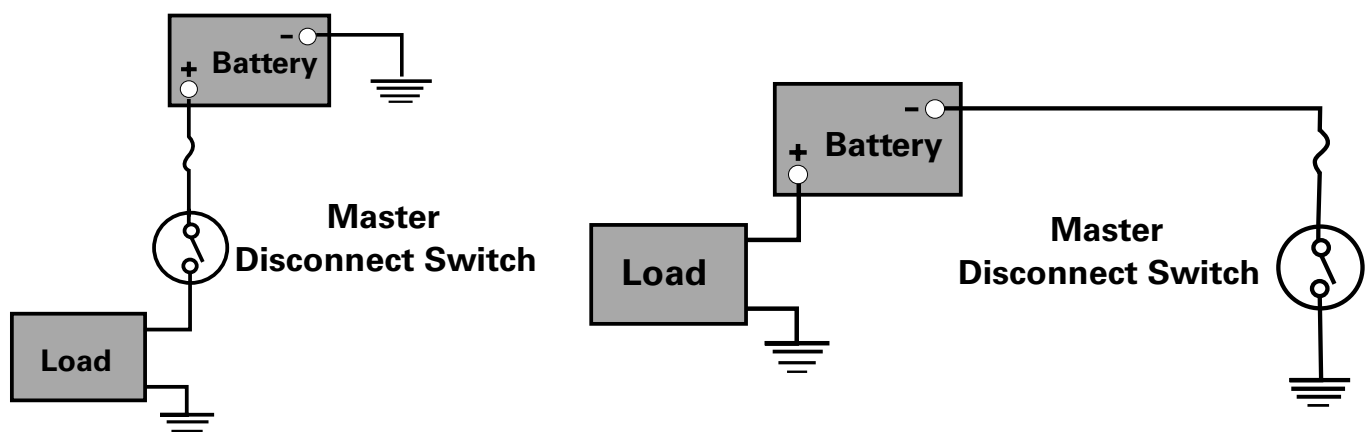

## BATTERY DISCONNECT SWITCH SELECTION

### IDENTIFY THE DUTY RATING OF THE SWITCHES BASED ON FOLLOWING PARAMETERS:

- Compare the rating of the alternator to the continuous current rating of the switch.
- Compare the starting current requirement during cold cranking to the intermittent current rating of the switch.
- Compare the short circuit current and time for the battery to the intermittent current rating of the switch.

### CABLE AND STUD SIZE

- The cable size, or gauge, has a significant effect on the performance of the switch. By extracting heat from the switch, larger cables will allow the switch to handle larger currents and last longer. The rating of the switch is based on minimum wire size. Please refer to the switch datasheet to understand how the switch is rated.
- It is important to match the terminal diameter of the switch to the cable size and ring terminal size.

### SWITCH MOUNTING LOCATION / ENVIRONMENTAL FACTORS

- Mounting location of the switch often determines the required level of sealing for the switch. If the switch will be mounted in an exposed location, consideration for sealed IP67 or IP69K should be given. If the switch is placed on in a protected location, then a splash-proof rated switch may only be needed.
- Plastic switches are less susceptible to corrosion issues than metal switches. For rugged applications, they are often just as robust and reliable as metal body switches especially for applications where the switch may be exposed to corrosive chemicals (such as road salt brines or acid wash).
- If the switch is mounted near a DPF (diesel particulate filter) subject to burn off, make sure the temperature rating of the switch is able to sustain operation without excessive derating.
- Stainless steel hardware for electrical connections greatly helps in preventing corrosion.

### MOUNTING METHOD

- Flange-mounted switches have a more finished appearance on the outside as they integrate the bezel and the switch markings, not requiring an external faceplate. However, they require a larger and sometimes irregular mounting hole as well as separate screws to mount.
- Shaft-mount switches are easier to mount as they require one or two drillable round holes. However, in most cases, they take up more room behind the panel.

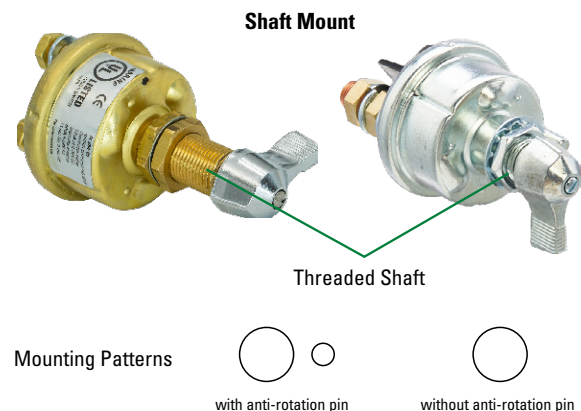
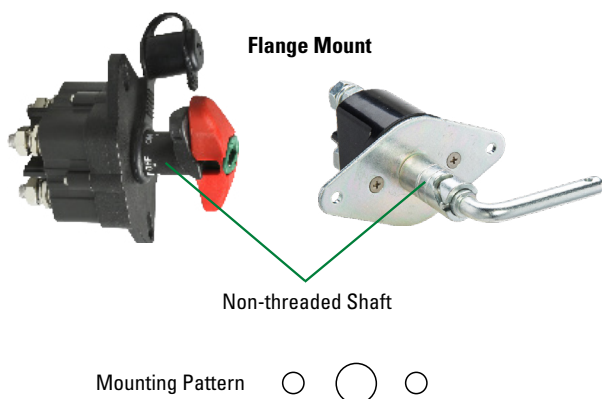

## LITTELFUSE BATTERY DISCONNECT PORTFOLIO

To meet the needs of different markets and customers, Littelfuse offers one of the most extensive portfolios of manual disconnect switches, ranging from 100A to 500A with a wide variety of types and features. Environmental factors can greatly affect a switch's ability to do its job and survive throughout the lifetime of the equipment. Littelfuse switches are specially designed and tested to work in any kind of harsh environment.

### SINGLE POLE SWITCHES

Single pole switches control one independent circuit within the electrical system. Mounting methods of Littelfuse single pole switches include through-hole shaft, flange mount, and surface mount. These switches support electrical systems having a nominal voltage range from 12V to 48V, continuous current rating from 100A to 500A, and up to 3000A intermittent current for 15 sec.

Single pole switches are available with different kinds of terminals depending upon the stud size (M8 & M10) and material (copper, brass, silver-plated, etc.). Single pole switches also have different kinds of actuators such as colored knobs, levers, and fixed and removable keys. Many also offer lockout-tagout options for security purposes.

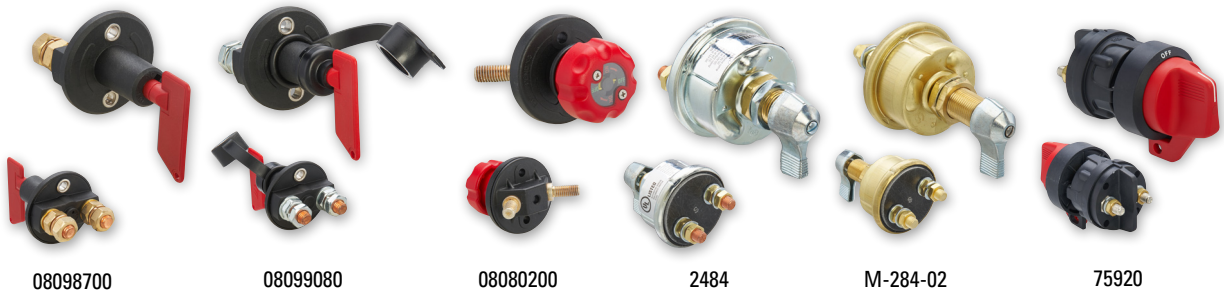

### DOUBLE POLE SWITCHES

Double pole switches control two independent circuits within the vehicle electrical system. Mounting methods of Littelfuse double pole switches include through hole shaft and flange mount. These switches support electrical systems having a nominal voltage range from 12V to 48V and continuous current rating from 125A to 500A and up to a maximum of 2250A intermittent current for 30 sec.

Double pole switches are also available with different kinds of terminals depending upon the stud size (M10 & M12) and material (copper, brass, silver plated, etc.). **These switches also provide options for lockout-tagout for safety and security purposes.**

There are 2 different kinds of double pole switches:

- **Complete Double Pole** - These kinds of switches control two complete high amperage circuits.
- **Secondary Circuit Switches** - These kinds of switches control one main high-power circuit and one lower power circuit up to 20A via a set of smaller studs.



## SWITCH CLOSING CONTACT TYPES

### ROTATING CONTACT

Disconnect switches that utilize a rotary closing contact method are perfect solutions for commercial and marine vehicles where the switch can be placed outside or inside the cabin based on the usage. The Littelfuse 75920 series switches, the SR series, and other panel-mount battery switches come with wiping contacts. Wiping contacts offer several advantages:

- The wiping action of the rotary contacts helps their durability by continually cleaning the contacts and eliminating much of the need for precious metal contact areas.
- High contact force good for high-current contacts and thick material provides very good cycle life.
- Typically provides higher current relative to size and no false off due to direct drive.
- Less susceptible to arcing issues at low voltages due to construction.

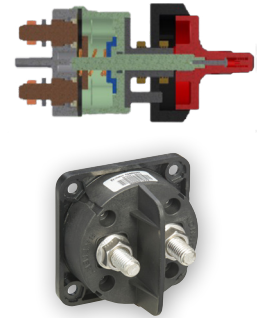

### PLUNGER CONTACT

Switches utilizing a plunger closing contact method are very common in disconnect switches. In these types of switches, rotary motion is translated to a linear motion through a ramp and only vertical movement of the contacts. **Littelfuse metal body switches, such as the 2484 series switches**, come with plunger style contacts which offer several advantages for the designer, including:

- Lower cost compared to rotating contacts;
- Fast translation of terminals, which opens the gap faster, providing a better solution for higher voltage applications; and Easier incorporation of magnetic blowouts for high-voltage contacts and arc dissipation.

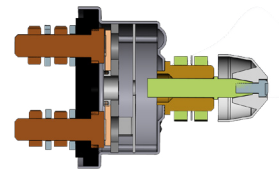

## SWITCH HOUSING MATERIAL

Most modern, high-performance, high-current switches are made with plastic housings. Plastic housings are tough, durable, and offer a higher level of sealing ingress protection, up to and beyond, as well as corrosion protection. The Littelfuse 75920 switch can use the same mounting hole pattern as many standard metal disconnect switches.

Littelfuse also offers various types of metal housing switches based on different levels of sealing and ingress protection, from IP53 to IP67. These switches come with rugged steel cases and provide options for silver-plated contacts, enabling high electrical conductivity and low contact resistance. The Littelfuse M-284 switch is specially designed for marine applications and comes with a brass case. Many metal switches are available with an anti-rotation pin which enables ease of mounting.

Some metal housing disconnect switches are available with zinc-plated steel housings, however, zinc may not be an ideal solution due to its galvanic corrosion potential in a marine environment. Thus, Littelfuse offers disconnect switches with brass housings for better protection against corrosion. Littelfuse also has switch options with plastic housings where corrosion resistance and durability are even better than brass.



75920



M-284



## DOUBLE NUT AND SINGLE NUT STUD ATTACHMENT

### DOUBLE NUT SWITCHES

Traditional disconnect switches mostly use two nuts to attach to a single switch stud. The top nut applies pressure to the cable terminal to hold it in place and provide a good electrical connection. Power is transferred from the nuts via the threads into the studs of the switch. The second, bottom nut is used to hold the stud to the switch base. Basically, it is the primary landing zone for electrical contact of the mating terminal. If the bottom nut is removed, this may render the switch unusable. Littelfuse metal housing switches usually come with double-nut studs.

### SINGLE NUT SWITCHES

Single nut switches use a stud that is permanently attached to the base. The stud and landing zone are made from a continuous piece of copper. This type of design is more efficient in transmitting electrical energy through the switch than passing it through the dual nut threads. For this reason, the 75920 switches with 3/8" studs are rated at 300+A continuous current, and the 2484 with 3/8" studs are rated at 175A continuous current.

## SEALING OPTIONS

Sealing is often required in a manual disconnect switch if it is exposed to the outside environment where there are chances for water or water vapor entry which may affect switch functionality or performance after a certain period. Water entry can also be the cause of corrosion to both the interior and exterior of the switch, potentially reducing the switch's life of operation

### IP67 AND IP69K

Littelfuse switches 880062, 880064, 880154, 880175, 08084300, 0808440, 08080570, 75920 & 75921 are specially designed for harsh environments. These kinds of switches have the greatest strength and capability against any kind of particulate ingress such as dust particles and water entry with their IP67/IP69K IP rating. These switches are capable of being fully immersed in water and can survive many kinds of harsh environment. The IP69K rating provides an extra high pressure, hot water wash test designed to simulate hot pressure wash cleaning.

### IP65 TO IP66

Switches with an IP65 to IP66 rating are not immersible but have been tested for higher pressure washing. Littelfuse knob-type switches 08080200, 08098400; flange mount switches 08010100, 08098800, 08098881, 08098882; and surface mount switch 08010200 are specially designed with IP65 sealing options.



2484



75920



880175



880064



880062

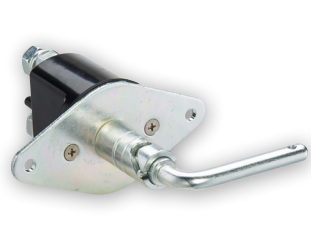

08098800



08098881



08080200



08098400















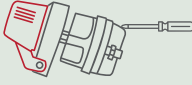

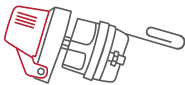
08010100

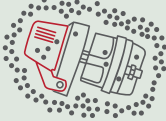
## HARSH ENVIRONMENTS AND INGRESS PROTECTION RATINGS

Environmental factors play a huge role in a product's ability to do its job and survive the lifetime of the equipment. Ingress Protection, or IP, indicates the degree of protection of a switch housing. IP ratings are a measure of how resistant a part is to environmental contaminants such as dust and water. IP rating selections should be based on where the switch will be mounted and what type of environment the equipment will be used in.

The numbers following IP represent levels of sealing and can range from no sealing (IP00) to protection against dust and continuous immersion in water (IP68). The table below provides a description of the protection at each level.

1st Digit - SOLID Degree of protection against solid objects		2nd Digit - LIQUID Degree of protection against water	
	<b>1</b> Protected against a solid object greater than 50mm		<b>1</b> Protected against vertically falling water drops
	<b>2</b> Protected against a solid object greater than 12.5mm		<b>2</b> Protected against vertical water drops when enclosure tilted up to 15 degree angle
	<b>3</b> Protected against a solid object greater than 2.5mm		<b>3</b> Protected against spraying water from up to a 60 degree angle
	<b>4</b> Protected against a solid object greater than 1.0mm		<b>4</b> Protected against splashing water
	<b>5</b> Dust Protected. Prevents ingress of dust sufficient to cause harm		<b>5</b> Protected against water jets
	<b>6</b> Dust tight. No ingress of dust.		<b>6</b> Protected against powerful water jets
<p><b>Example</b></p> <p><b>IP67</b></p> <p>Dust tight. No ingress of dust. Protected against effects of temporary submersion in water.</p>			<b>7</b> Protected against the effects of temporary immersion in water
			<b>8</b> Protected against the effects of continuous immersion in water under conditions agreed between manufacturer and user
			<b>9K</b> Protected against close-range high pressure, high temperature spray downs



## MANUAL DISCONNECT SWITCH MARKET

**Manual disconnect switches are lower in cost than relays and are perceived as less susceptible to failure due to simplicity.**

- Most medium- and light-duty trucks and buses use manual disconnect switches. Heavy-duty trucks also use manual battery disconnect switches in critical safety applications.
- In agriculture, lower HP tractors tend to use master disconnect switches rather than relays due to their simplicity and lower cost.
- In off-road vehicles, especially construction equipment, master disconnect switches are a preferred solution by designers due to similar reasons as Ag equipment.
- In material handling, most man lift manufacturers use manual disconnect switches due to safety requirements. Disconnect switches can be used for forklifts as well but are not usually required.
- In small commercial vehicles, there is a huge demand for manual disconnect switches mostly with a 100A to 200A range due to its compact size and lower cost vs. a disconnect relay.



## FUTURE SCOPE FOR MANUAL DISCONNECT SWITCHES

Demand for higher voltage vehicles will be increasing in the coming years. Due to automation and continuous advancement in all kinds of vehicles, there will be a huge demand for new technology, higher efficiency, and higher quality products. The market will need manual disconnect switches which can be operated in high voltage as well. For hybrid electrical vehicles, agriculture, construction, small commercial vehicles, and material handling, there will be demand for 48V-100V switches. For trucks, buses, higher-end agriculture, construction, and material handling applications, there will be demand for 350V-1000V service disconnects to disconnect the supply from high-voltage PDUs.

To meet the market demand, our next generation disconnect switches will be designed for future markets, including EV and fuel cell with a current range from 100A to 500A. Advanced features such as integrated fusing and sensing technology are being developed. Littelfuse continues to invest in developing new and more advanced products in this important product line.



For more information, visit  
[littelfuse.com/MDS](http://littelfuse.com/MDS)