

REVISION		
REV	DATE	DESCRIPTION
A	10/13/22	525730GCP - RELEASE MRY
B	11/3/22	525897ECP/D - CHANGE TOLERANCE & WIRE RANGE MRY

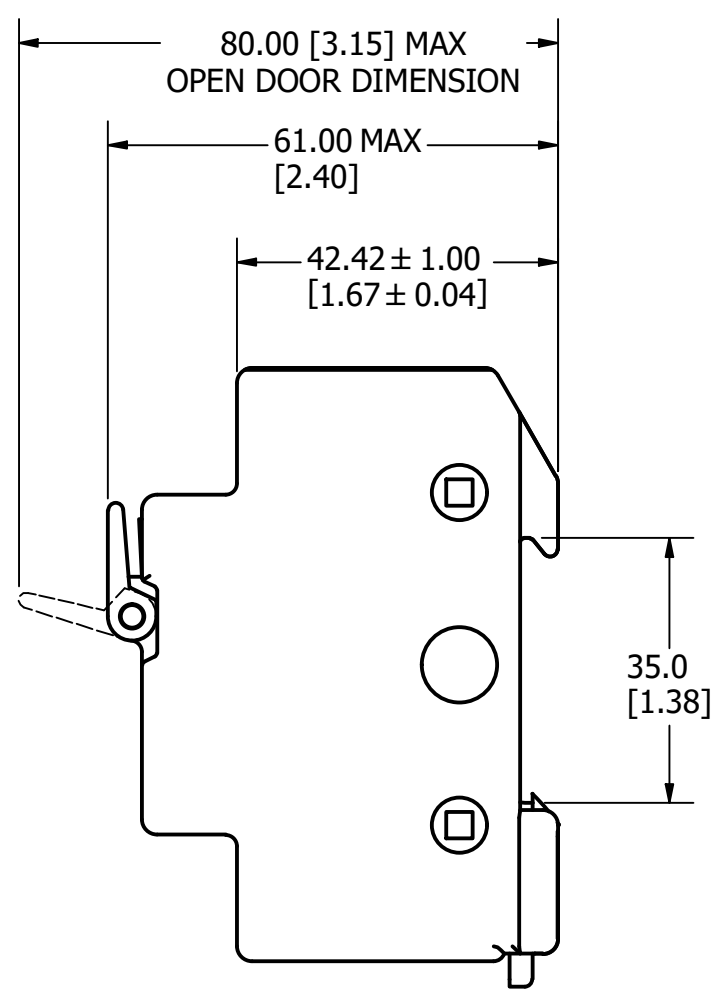
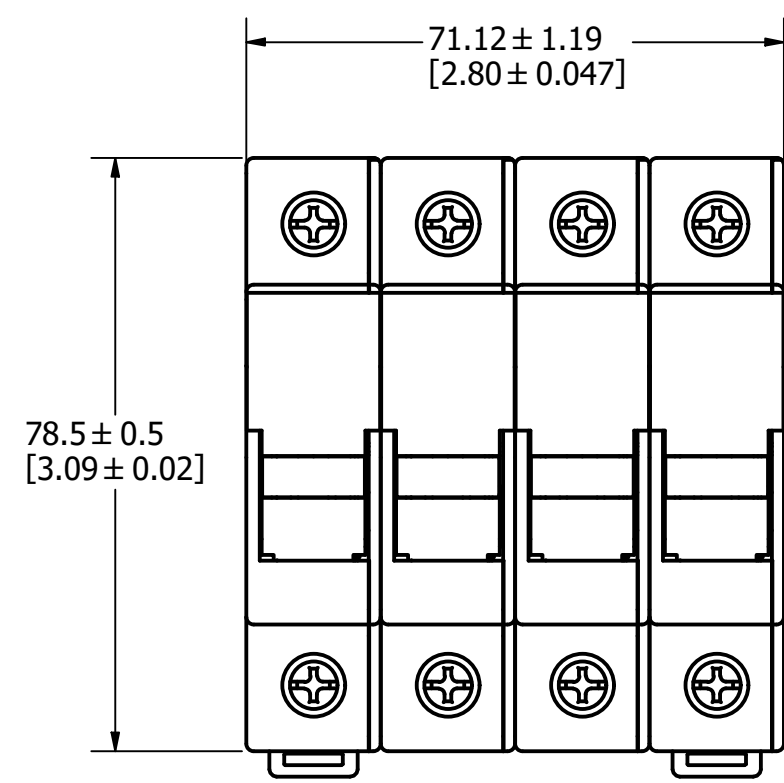

SPECIFICATIONS:

VOLTAGE RATING: 600V

AMP RATING: 30 AMPERES

INTERRUPT RATING: 100kA

WIRE RANGE: #8-14 AWG STRANDED Cu ONLY UL CLASS B & CLASS C WIRE
#10-14 AWG SOLID Cu ONLY

SUGGESTED TORQUE: 2 N-m [17.7 IN-LB]

APPROVALS: UL RECOGNIZED (FILE NO. E14721)
CSA CERTIFIED (FILE NO. LR7316)

1	NO	COMPONENT NO	DESCRIPTION	QTY/M	U/M
BILL OF MATERIAL					
<S>	CRITICAL CHARACTERISTIC FOR PART SAFETY/COMPLIANCE				
●	DENOTES CRITICAL CHARACTERISTICS.				
CPK	DENOTES CPK DIMENSIONS, -MINIMUM CPK VALUE				
⊞	DENOTES A CHARACTERISTIC THAT PROVIDES AN INDICATION OF PROCESS PERFORMANCE. PROCEDURE FOR MEASUREMENT AND TRACKING TO BE DEFINED IN LITTELFUSE INSPECTION INSTRUCTIONS.				
CP	DENOTES CP DIMENSIONS, -MINIMUM CP VALUE MUST BE WITHIN THE DIMENSIONAL LIMITATIONS SHOWN ON DRAWING AND INITIALLY LOCATED TO ALLOW FOR MAXIMUM TOOL LIFE.				
MATL SPEC			FINISH		
DRW JMOLER	DATE 9/30/2022	SCALE NTS	FINISH GOOD WT GRAMS/PIECE		
UNLESS OTHERWISE SPECIFIED, DIMENSIONS ARE IN MILLIMETERS, DIMENSIONS IN BRACKETS [] ARE INCHES DIMENSIONING AND DO NOT INCLUDE PLATING. TOLERANCING TO BE INTERPRETED IN ACCORDANCE WITH ANSI Y14.5M-1994					
3RD ANGLE PROJECTION					
TITLE LPSM004 OUTLINE					
Littelfuse CHICAGO, ILLINOIS 60631		REVISION B	DRWG NO. OL-LPSM004	SHEET 1 OF 1	