

LOW PROFILE MINI® 10.9 Series

Blade Fuses – Rated 58V

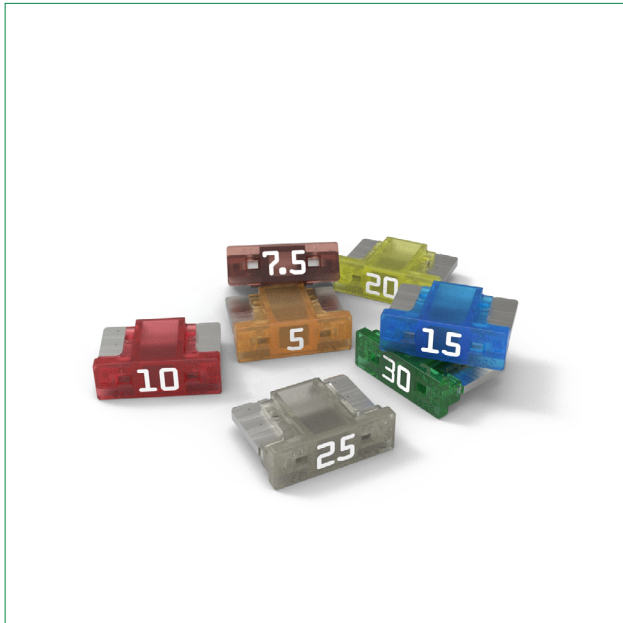

Description

Low Profile MINI® 10.9mm fuses offer space and weight savings without sacrificing circuit protection. Despite their small size, these low-profile automotive fuses perform similarly to other MINI 58V blade fuses.

Features & Benefits

- Color coding shows the amperage rating for each fuse
- Checkpoints on top make it possible to measure resistance without removing the fuse
- High-contrast amperage stamp on the top of the housing aids identification
- See-through housing makes it easy to check whether a fuse has blown
- Offers additional material savings by reducing the need for sockets
- Simple to install and remove
- Comply with ISO 8820-9

Applications

- Cars / SUVs
- Trucks
- Offroad vehicles
- Buses
- Watercraft as approved by Littelfuse®

Agency Approvals

Agency	Agency File Number	Current Rating (A)
	20130320-E71611	5 – 30

Additional Information



Resources



Samples

Specifications

Voltage Rating:	58 V DC
Interrupting Rating:	1000 A @ 58 V DC
Recommended Environmental Temperature:	-40 °C to +125 °C
Terminals Material:	Silver plated zinc
Housing Material:	PA66 (U.L. 94 Flammability rating – HB)
Typical Weight per Fuse:	0.4 g
Comply With:	ISO 8820-9

*Note: Silver plating allows up to 150 °C at the terminal interface.







Ordering Information

Part Number	Current Rating (A)	Package Size
0891xxx.NXWS	5 – 30	5000

LOW PROFILE MINI® 10.9 Series

Blade Fuses – Rated 58V

Ratings

Part Number	Current Rating (A)	Housing Material Color	Test Cable Size (mm ²)	Typ. Voltage Drop (mV)	Typ. Cold Resistance (mΩ)	Typ. I ² t (A ² s)
0891005_	5		0.5	114	17.21	22
0891075_	7.5		0.75	105	10.65	53
0891010_	10		1	97	7.59	102
0891015_	15		1.5	75	4.70	198
0891020_	20		2.5	99	3.35	420
0891025_	25		2.5	96	2.56	613
0891030_	30		4	96	2.06	1100

Note: The typical I²t is an average value calculated from the breaking capacity tests by using the melting time before the arcing occurs.

Dimensions

Dimensions in mm. Please refer to the outline drawing for dimensions and tolerances.

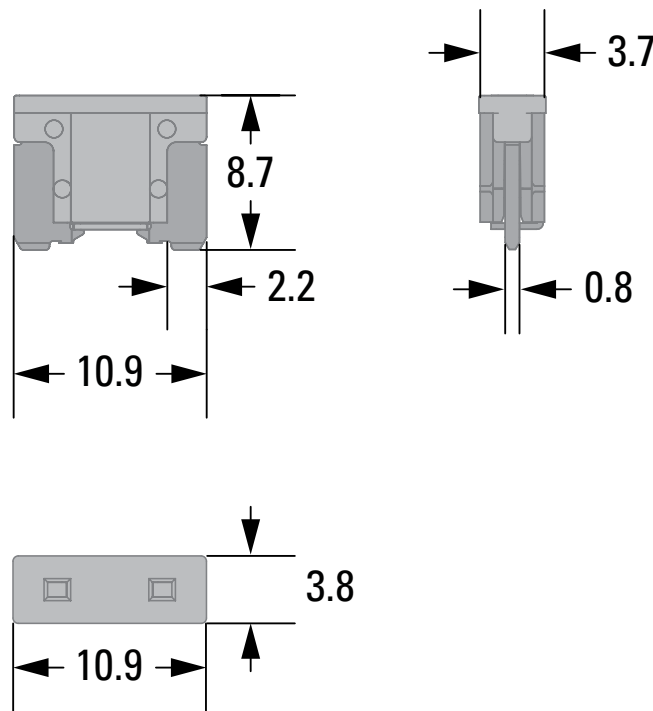

LOW PROFILE MINI® 10.9 Series

Blade Fuses – Rated 58V

Time-Current Characteristic

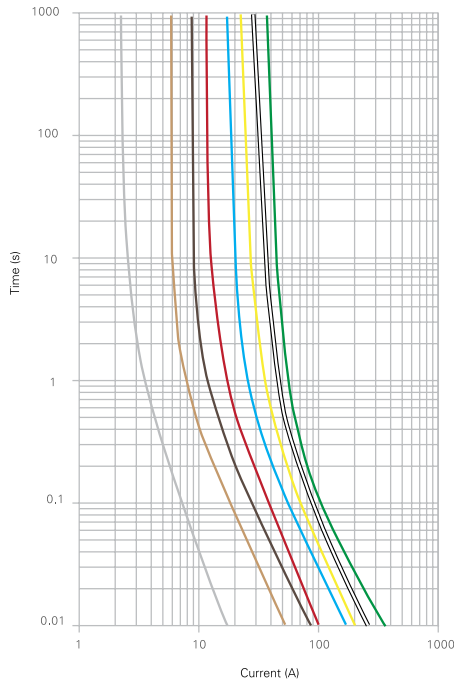

% of Rating	Opening Time Min. / Max. (s)
110	360 000 / -
135	0.75 / 120
200	0.15 / 5
350	0.08 / 0.25
600	0.03 / 0.1

- 2 A — 15 A
- 5 A — 20 A
- 7.5 A — 25 A
- 10 A — 30 A

Note: Current recommendation may be impacted by the final condition of the application (terminals characteristics, wire size etc.). Please contact Littelfuse® for more information.

Disclaimer Notice - Information furnished is believed to be accurate and reliable. However, users should independently evaluate the suitability of and test each product selected for their own applications. Littelfuse products are not designed for, and may not be used in, all applications. Read complete Disclaimer Notice at <https://www.littelfuse.com/legal/disclaimers/product-disclaimer.aspx>