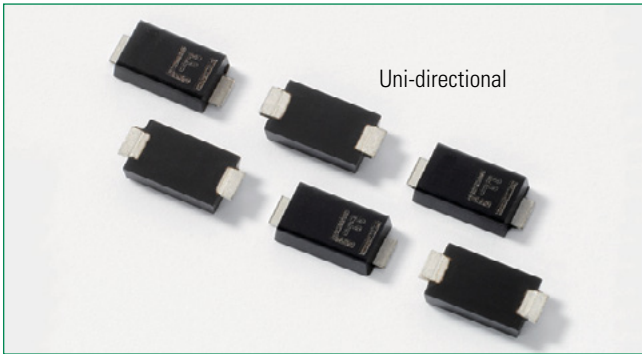


**SMA6L Series**



**Agency Approvals**

Agency	Agency File Number
	E230531

**Maximum Ratings and Thermal Characteristics**  
(T<sub>A</sub> = 25°C unless otherwise noted)

Parameter	Symbol	Value	Unit
Peak Pulse Power Dissipation at T <sub>A</sub> = 25°C by 10/1000µs Waveform (Fig.2) (Note 1,2,3)	P <sub>PPM</sub>	600	W
Power Dissipation on Infinite Heat Sink at T <sub>L</sub> = 50°C	P <sub>D</sub>	3	W
Peak Forward Surge Current, 8.3ms Single Half Sine Wave (Note 4)	I <sub>FSM</sub>	60	A
Maximum Instantaneous Forward Voltage at 25A for Unidirectional Only	V <sub>F</sub>	3.5	V
Operating Temperature Range	T <sub>J</sub>	-65 to 150	°C
Storage Temperature Range	T <sub>STG</sub>	-65 to 175	°C
Typical Thermal Resistance Junction to Lead	R <sub>θJL</sub>	35	°C/W
Typical Thermal Resistance Junction to Ambient	R <sub>θJA</sub>	200	°C/W

- Notes:**
1. Non-repetitive current pulse, per Fig.4 and derated above T<sub>J</sub> (initial) = 25°C per Fig. 3.
  2. Mounted on 5.0x5.0mm copper pad to each terminal.
  3. SMA6L150A-SMA6L250A Peak Pulse Power Dissipation by 10/1000µs Waveform (PPPM) is 400W
  4. Measured on 8.3ms single half sine wave or equivalent square wave for unidirectional device only.

**Functional Diagram**



**Description**

The SMA6L series is designed specifically to protect sensitive electronic equipment from voltage transients induced by lightning and other transient voltage events.

The SMA6L low profile package has the same power performance as the SMB package but with lowest height profiles (1.1mm) in the industry.

**Features**

- Same power as standard SMB devices (600 W)
- SMA low profile package: less than 1.1 mm
- Footprint compatibility with standard SMA and SMB products (easy to layout)
- Typical failure mode is a short circuit condition for current events exceeding component rating
- Whisker test is conducted based on JEDEC JESD201A per its table 4a and 4c
- IEC 61000-4-2 ESD 30kV(Air), 30kV (Contact)
- EFT protection of data lines in accordance with IEC 61000-4-4
- Low inductance, excellent clamping capability
- Fast response time: typically less than 1.0ns from 0 Volts to V<sub>BR</sub> min
- Built-in strain relief
- Glass passivated junction
- Typical IR < 1µA when V<sub>BR</sub> min > 12 V
- High temperature reflow soldering guaranteed: 260°C/40sec
- V<sub>BR</sub> @ T<sub>J</sub> = V<sub>BR</sub> @ 25°C x (1 + αT x (T<sub>J</sub> - 25)) (αT: Temperature Coefficient, typical value is 0.1%)
- UL Recognized compound meeting flammability rating V-0
- Meet MSL level1, per J-STD-020, lead-frame maximum peak of 260°C
- Matte tin lead-free plated
- Halogen free and RoHS compliant
- Pb-free E3 means 2<sup>ND</sup> level interconnect is Pb-free and the terminal finish material is tin(Sn) (IPC/JEDEC J-STD-609A.01)

**Applications**

TVS components are ideal for the protection of I/O Interfaces, V<sub>CC</sub> bus and other vulnerable circuits used in Telecom, Computer, Industrial and Consumer electronic applications.

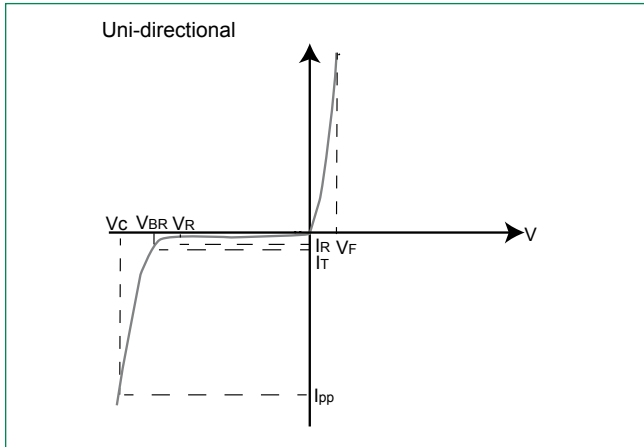
**Additional Information**



### Electrical Characteristics (T<sub>A</sub>=25°C unless otherwise noted)

Part Number (Uni)	Marking Code	Reverse Stand off Voltage V <sub>R</sub> (Volts)	Breakdown Voltage V <sub>BR</sub> (Volts) @ I <sub>T</sub>		Test Current I <sub>T</sub> (mA)	Maximum Clamping Voltage V <sub>C</sub> @ I <sub>PP</sub> (V)	Maximum Peak Pulse Current I <sub>PP</sub> (A)	Maximum Reverse Leakage I <sub>R</sub> @ V <sub>R</sub> (µA)	Agency Approval 
			MIN	MAX					
SMA6L5.0A	AE	5.0	6.40	7.00	10	9.2	65.3	800	x
SMA6L6.0A	AG	6.0	6.67	7.37	10	10.3	58.3	800	x
SMA6L6.5A	AK	6.5	7.22	7.98	10	11.2	53.6	500	x
SMA6L7.0A	AM	7.0	7.78	8.60	10	12.0	50.0	200	x
SMA6L7.5A	AP	7.5	8.33	9.21	1	12.9	46.6	100	x
SMA6L8.0A	AR	8.0	8.89	9.83	1	13.6	44.2	50	x
SMA6L8.5A	AT	8.5	9.44	10.40	1	14.4	41.7	20	x
SMA6L9.0A	AV	9.0	10.00	11.10	1	15.4	39.0	10	x
SMA6L10A	AX	10.0	11.10	12.30	1	17.0	35.3	5	x
SMA6L11A	AZ	11.0	12.20	13.50	1	18.2	33.0	1	x
SMA6L12A	BE	12.0	13.30	14.70	1	19.9	30.2	1	x
SMA6L13A	BG	13.0	14.40	15.90	1	21.5	28.0	1	x
SMA6L14A	BK	14.0	15.60	17.20	1	23.2	25.9	1	x
SMA6L15A	BM	15.0	16.70	18.50	1	24.4	24.6	1	x
SMA6L16A	BP	16.0	17.80	19.70	1	26.0	23.1	1	x
SMA6L17A	BR	17.0	18.90	20.90	1	27.6	21.8	1	x
SMA6L18A	BT	18.0	20.00	22.10	1	29.2	20.6	1	x
SMA6L20A	BV	20.0	22.20	24.50	1	32.4	18.6	1	x
SMA6L22A	BX	22.0	24.40	26.90	1	35.5	16.9	1	x
SMA6L24A	BZ	24.0	26.70	29.50	1	38.9	15.5	1	x
SMA6L26A	CE	26.0	28.90	31.90	1	42.1	14.3	1	x
SMA6L28A	CG	28.0	31.10	34.40	1	45.4	13.3	1	x
SMA6L30A	CK	30.0	33.30	36.80	1	48.4	12.4	1	x
SMA6L33A	CM	33.0	36.70	40.60	1	53.3	11.3	1	x
SMA6L36A	CP	36.0	40.00	44.20	1	58.1	10.4	1	x
SMA6L40A	CR	40.0	44.40	49.10	1	64.5	9.3	1	x
SMA6L43A	CT	43.0	47.80	52.80	1	69.4	8.7	1	x
SMA6L45A	CV	45.0	50.00	55.30	1	72.7	8.3	1	x
SMA6L48A	CX	48.0	53.30	58.90	1	77.4	7.8	1	x
SMA6L51A	CZ	51.0	56.70	62.70	1	82.4	7.3	1	x
SMA6L54A	RE	54.0	60.00	66.30	1	87.1	6.9	1	x
SMA6L58A	RG	58.0	64.40	71.20	1	93.6	6.5	1	x
SMA6L60A	RK	60.0	66.70	73.70	1	96.8	6.2	1	x
SMA6L64A	RM	64.0	71.10	78.60	1	103.0	5.9	1	x
SMA6L70A	RP	70.0	77.80	86.00	1	113.0	5.3	1	x
SMA6L75A	RR	75.0	83.30	92.10	1	121.0	5.0	1	x
SMA6L78A	RT	78.0	86.70	95.80	1	126.0	4.8	1	x
SMA6L85A	RV	85.0	94.40	104.00	1	137.0	4.4	1	x
SMA6L90A	RX	90.0	100.0	111.00	1	146.0	4.2	1	x
SMA6L100A	RZ	100.0	111.0	123.00	1	162.0	3.7	1	x
SMA6L 110A	SE	110.0	122.0	135.00	1	177.0	3.4	1	x
SMA6L120A	SG	120.0	133.0	147.00	1	193.0	3.2	1	x
SMA6L 130A	SK	130.0	144.0	159.00	1	209.0	2.9	1	x
SMA6L150A	SM	150.0	167.0	185.00	1	243.0	1.65	1	x
SMA6L160A	SP	160.0	178.0	197.00	1	259.0	1.55	1	x
SMA6L170A	SR	170.0	189.0	209.00	1	275.0	1.50	1	x
SMA6L180A	ST	180.0	201.0	222.00	1	292.0	1.40	1	x
SMA6L185A	SU	185.0	209.0	231.00	1	303.0	1.40	1	x
SMA6L200A	SV	200.0	224.0	247.00	1	324.0	1.25	1	x
SMA6L215A	SW	215.0	237.0	263.00	1	344.0	1.17	1	x
SMA6L220A	SX	220.0	246.0	272.00	1	356.0	1.13	1	x
SMA6L250A	SZ	250.0	279.0	309.00	1	405.0	0.95	1	x

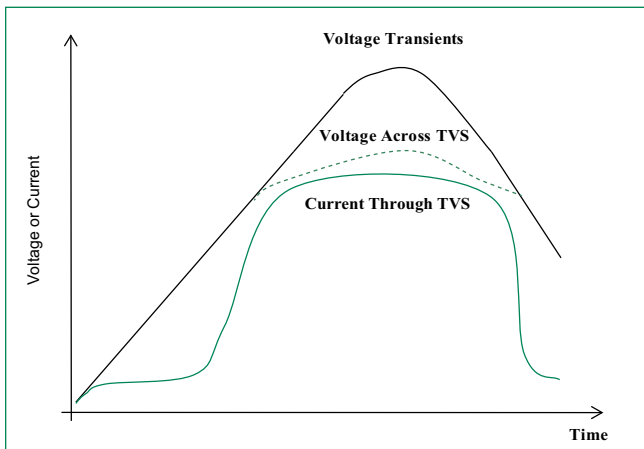
**I-V Curve Characteristics**



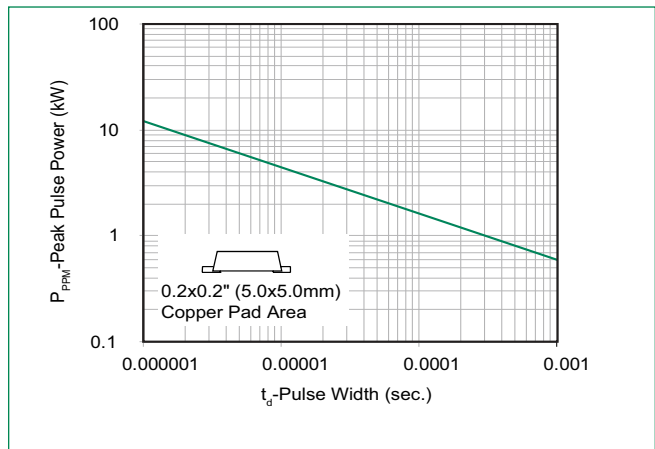
- $P_{PPM}$  Peak Pulse Power Dissipation** – Max power dissipation
- $V_R$  Stand-off Voltage** – Maximum voltage that can be applied to the TVS without operation
- $V_{BR}$  Breakdown Voltage** – Maximum voltage that flows through the TVS at a specified test current ( $I_T$ )
- $V_C$  Clamping Voltage** – Peak voltage measured across the TVS at a specified  $I_{PPM}$  (peak impulse current @ 10/1000)
- $I_R$  Reverse Leakage Current** – Current measured at  $V_R$
- $V_F$  Forward Voltage Drop for Uni-directional**

**Ratings and Characteristic Curves ( $T_A=25^\circ\text{C}$  unless otherwise noted)**

**Figure 1 - TVS Transients Clamping Waveform**



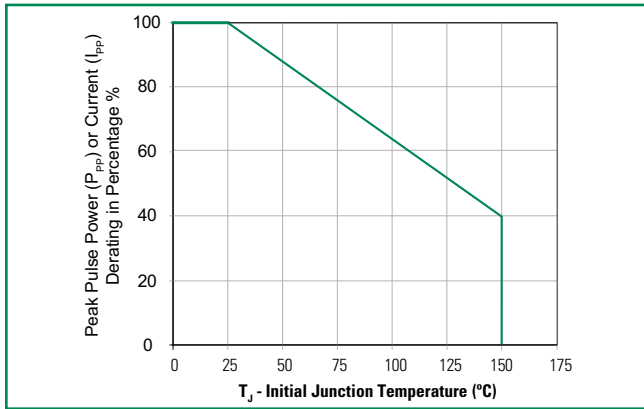
**Figure 2 - Peak Pulse Power Rating Curve**



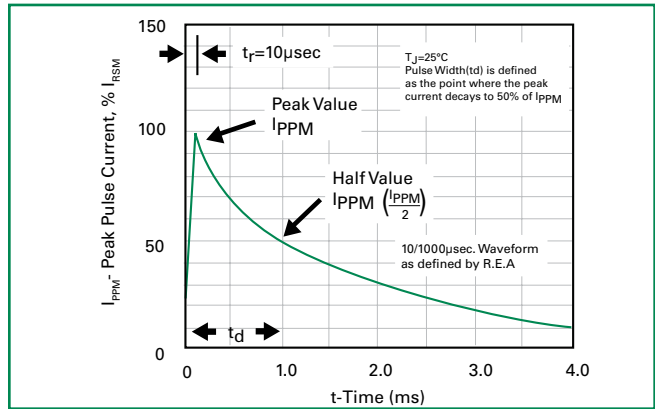
continues on next page.

**Ratings and Characteristic Curves** ( $T_A=25^\circ\text{C}$  unless otherwise noted) (Continued)

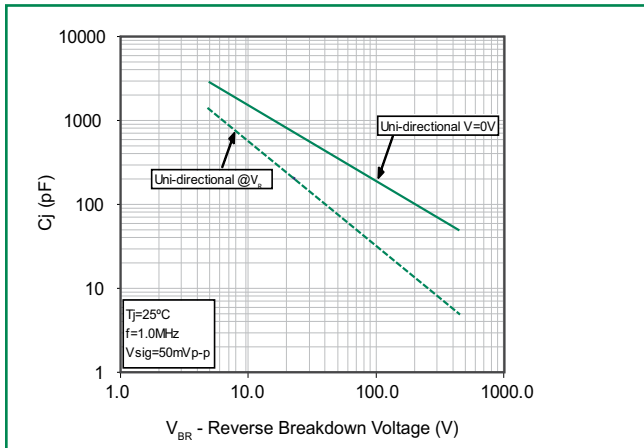
**Figure 3 - Peak Pulse Power Derating Curve**



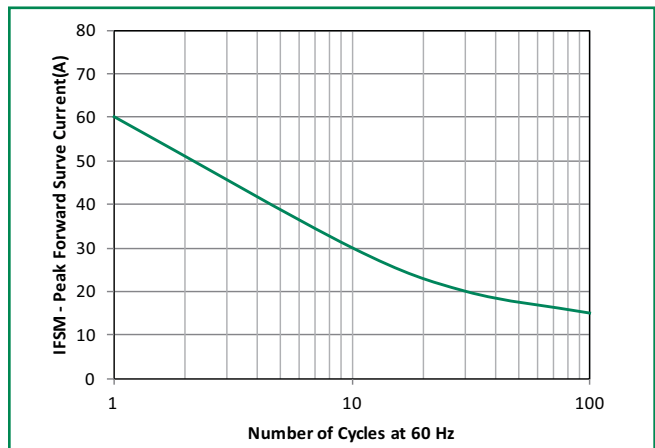
**Figure 4 - Pulse Waveform**



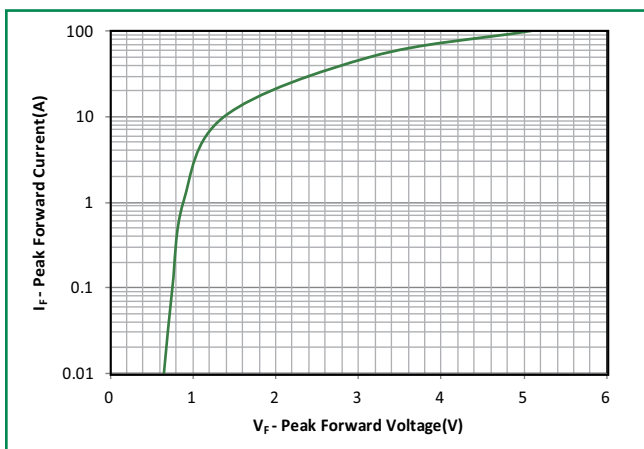
**Figure 5 - Typical Junction Capacitance**



**Figure 6 - Maximum Non-Repetitive Forward Surge Current Uni-Directional Only**

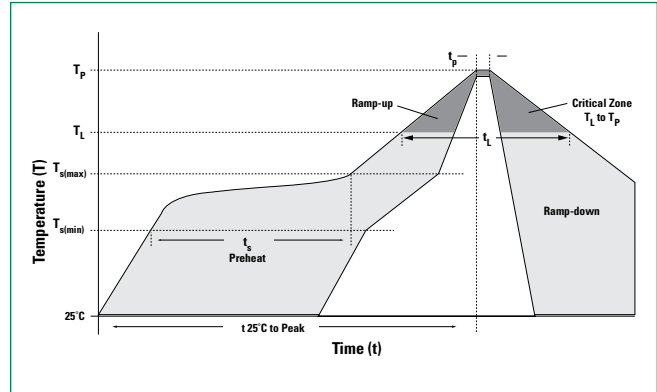


**Figure 7 - Peak Forward Voltage Drop vs Peak Forward Current (typical values)**



**Soldering Parameters**

<b>Reflow Condition</b>		Lead-free assembly
<b>Pre Heat</b>	- Temperature Min ( $T_{s(min)}$ )	150°C
	- Temperature Max ( $T_{s(max)}$ )	200°C
	- Time (min to max) ( $t_s$ )	60 – 180 secs
<b>Average ramp up rate (Liquidus Temp (<math>T_A</math>) to peak)</b>		3°C/second max
<b><math>T_{S(max)}</math> to <math>T_A</math> - Ramp-up Rate</b>		3°C/second max
<b>Reflow</b>	- Temperature ( $T_A$ ) (Liquidus)	217°C
	- Time (min to max) ( $t_s$ )	60 – 150 seconds
<b>Peak Temperature (<math>T_p</math>)</b>		260 <sup>+0/-5</sup> °C
<b>Time within 5°C of actual peak Temperature (<math>t_p</math>)</b>		20 – 40 seconds
<b>Ramp-down Rate</b>		6°C/second max
<b>Time 25°C to peak Temperature (<math>T_p</math>)</b>		8 minutes Max.
<b>Do not exceed</b>		260°C



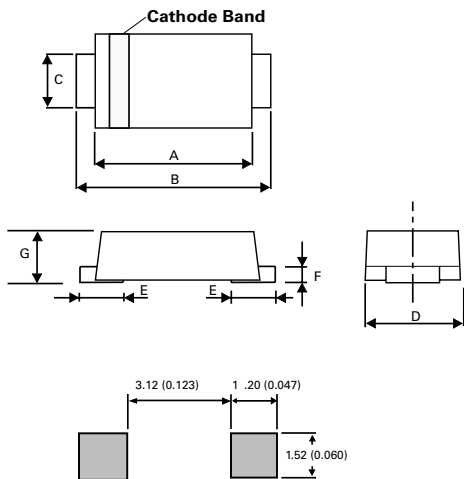
**Physical Specifications**

<b>Weight</b>	0.002 ounce, 0.032 gram
<b>Case</b>	JEDEC DO-221AC Molded Plastic over glass passivated junction
<b>Polarity</b>	Color band denotes cathode except Bipolar
<b>Terminal</b>	Matte Tin-plated leads, Solderable per JESD22-B102

**Environmental Specifications**

<b>High Temp. Storage</b>	JESD22-A103
<b>HTRB</b>	JESD22-A108
<b>Temperature Cycling</b>	JESD22-A104
<b>MSL</b>	JEDEC-J-STD-020, Level 1
<b>H3TRB</b>	JESD22-A101
<b>RSH</b>	JESD22-A111

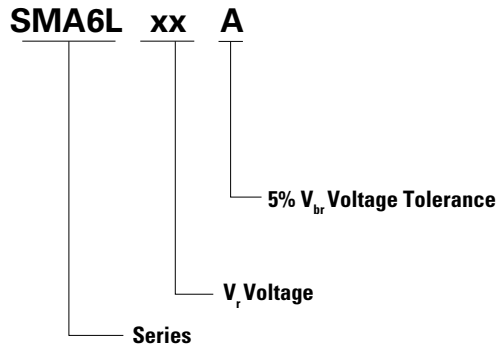
**Dimensions**



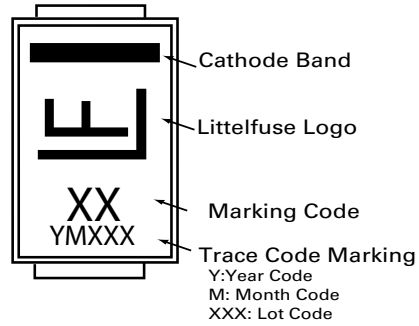
**Mounting Pad Layout**

Dimensions	Inches		Millimeters	
	Min	Max	Min	Max
A	0.156	0.181	3.950	4.600
B	0.189	0.220	4.800	5.600
C	0.049	0.069	1.250	1.750
D	0.088	0.116	2.250	2.950
E	0.030	0.059	0.750	1.500
F	0.005	0.010	0.125	0.250
G	0.035	0.043	0.900	1.100

**Part Numbering System**



**Part Marking System**



**Packaging**

Part number	Component Package	Quantity	Packaging Option	Packaging Specification
SMA6LxxA	DO-221AC	3000	Tape & Reel – 12mm/7" tape	EIA RS-481

**Tape and Reel Specification**

