

# Qxx15xx and Qxx16xHx Series

## 15 A Standard and 16 A Alternistor (High Commutation) TRIACs

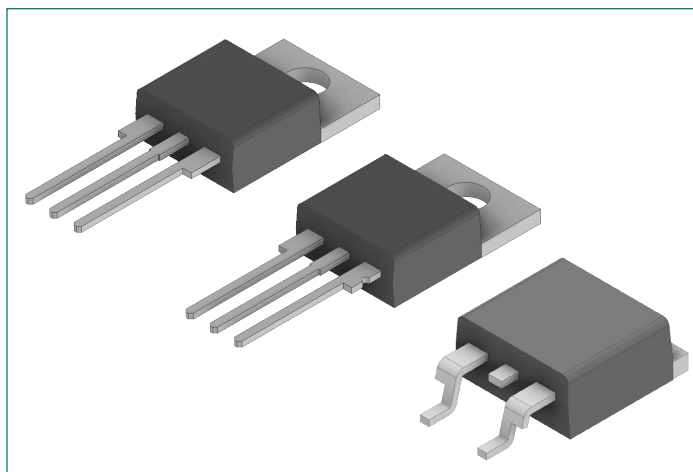

### Pinout Diagram

TO-220 (L-Package)

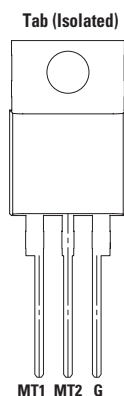

TO-220 (R-Package)

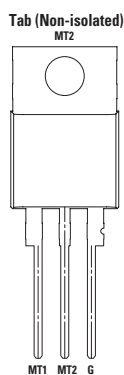

TO-263

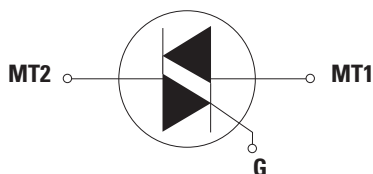
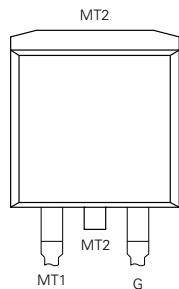

**MT1:** Main Terminal 1; **MT2:** Main Terminal 2; **G:** Gate

### Description:

This 15 A and 16 A bi-directional solid state switch series is designed for AC switching and phase control applications such as motor speed, temperature modulation controls, lighting controls, and static switching relays.

Standard type devices normally operate in Quadrants I & III triggered from AC line.

Standard Alternistor TRIAC components operate with in-phase signals in Quadrants I or III and ONLY unipolar negative gate pulses for Quadrant II or III. The Alternistor TRIAC will not operate in Quadrant IV. These are used in circuit applications requiring high dv/dt capability.

### Features:

- RoHS-compliant
- Glass-passivated junctions
- Voltage capability up to 1000 V
- Surge capability up to 200 A
- The L package has an isolation rating of 2500 V<sub>RMS</sub>
- Restricted (or limited) RFI generation, depending on activation point in sine wave
- Recognized to UL 1557 as an Electrically Isolated Semiconductor Device (L package: file number E71639)

### Benefits:

- Requires only a small gate activation pulse in each half-cycle
- Solid-state switching eliminates arcing or contact bounce that create voltage transients
- Internally constructed isolated packages provide ease of heat sinking with highest isolation voltage
- No contacts to wear out from reaction of switching events

### Applications:

Excellent for AC switching and phase control applications such as heating, lighting, and motor speed control, typical applications are AC solid-state switches, light dimmers, power tools, lawn care equipment, home/brown goods and white goods appliances.

Alternistor TRIACs (no snubber required) are used in applications with extremely inductive loads requiring highest commutation performance.

### Product Summary

Characteristic	Value	Unit
$I_{T(RMS)}$	15 or 16	A
$V_{DRM}/V_{RRM}$	400, 600, 800, or 1000	V
$I_{GT(Q1)}$	10, 20, 35, 50, or 80	mA

# Qxx15xx and Qxx16xHx Series

## 15 A Standard and 16 A Alternistor (High Commutation) TRIACs

### Maximum Ratings - Standard TRIAC

Symbol	Characteristics	Conditions			Value	Units
$I_{T(RMS)}$	On-state RMS Current	Qxx15Ly	$T_C = 80\text{ }^\circ\text{C}$	full sine wave	15	A
		Qxx15Ry/ Qxx15Ny	$T_C = 90\text{ }^\circ\text{C}$			
$I_{TSM}$	Non-repetitive Surge Peak On-state Current	f = 50 Hz, t = 20 ms	$T_{vj}$ initial = 25 °C, full cycle		167	A
		f = 60 Hz, t = 16.7 ms			200	
$I^2t$	$I^2t$ Value for Fusing	$t_p = 8.3\text{ ms}$			166	A <sup>2</sup> s
di/dt	Critical Rate of Rise of On-state Current	f = 120 Hz, $T_{vj} = 125\text{ }^\circ\text{C}$			100	A/ $\mu$ s
$I_{GTM}$	Peak Gate Trigger Current	$t_p = 20\text{ }\mu\text{s}$ , $T_{vj} = 125\text{ }^\circ\text{C}$			4	A
$P_{G(AV)}$	Average Gate Power Dissipation	$T_{vj} = 125\text{ }^\circ\text{C}$			0.5	W
$T_{stg}$	Storage Temperature Range	-			-40 to 150	°C
$T_{vj}$	Operating Junction Temperature Range	-			-40 to 125	°C

xx = voltage/10; y = sensitivity

### Maximum Ratings - Alternistor TRIAC (3 Quadrants)

Symbol	Characteristics	Conditions			Value	Units
$I_{T(RMS)}$	On-state RMS Current	Qxx16Ly	$T_C = 80\text{ }^\circ\text{C}$	full sine wave	16	A
		Qxx16Ry/ Qxx16Ny	$T_C = 90\text{ }^\circ\text{C}$			
$I_{TSM}$	Non-repetitive Surge Peak On-state Current	f = 50 Hz, t = 20 ms	$T_{vj}$ initial = 25 °C, full cycle		167	A
		f = 60 Hz, t = 16.7 ms			200	
$I^2t$	$I^2t$ Value for Fusing	$t_p = 8.3\text{ ms}$			166	A <sup>2</sup> s
di/dt	Critical Rate of Rise of On-state Current	f = 120 Hz, $T_{vj} = 125\text{ }^\circ\text{C}$			100	A/ $\mu$ s
$I_{GTM}$	Peak Gate Trigger Current	$t_p = 20\text{ }\mu\text{s}$ , $T_{vj} = 125\text{ }^\circ\text{C}$			4	A
$P_{G(AV)}$	Average Gate Power Dissipation	$T_{vj} = 125\text{ }^\circ\text{C}$			0.5	W
$T_{stg}$	Storage Temperature Range	-			-40 to 150	°C
$T_{vj}$	Operating Junction Temperature Range	-			-40 to 125	°C

xx = voltage/10; y = sensitivity

### Electrical Characteristics ( $T_{vj} = 25\text{ }^\circ\text{C}$ , unless otherwise specified) — Standard TRIAC

Symbol	Characteristics	Conditions	Value			Units	
			Min.	Typ.	Max.		
$I_{GT}$	DC Gate Trigger Current	$V_D = 12\text{ V}$ , $R_L = 60\text{ }\Omega$	I – II – II	–	–	50	mA
$V_{GT}$	DC Gate Trigger Voltage		I – II – II	–	–	2.0	V
$V_{GD}$	Gate Non-trigger Voltage	$V_D = V_{DRM}$ , $R_L = 3.3\text{ k}\Omega$ , $T_{vj} = 125\text{ }^\circ\text{C}$	I – II – II	0.2	–	–	V
$I_H$	Holding Current	$I_T = 100\text{ mA}$		–	–	70	mA
dv/dt	Critical Rate-of-rise of Off-stage Voltage	$V_D = V_{DRM}$ , Gate Open, $T_{vj} = 125\text{ }^\circ\text{C}$	400 V	275	–	–	V/ $\mu$ s
			600 V	225	–	–	
			800 V	200	–	–	
		$V_D = 2/3 V_{DRM}$ , Gate Open, $T_{vj} = 100\text{ }^\circ\text{C}$	1000 V	200	–	–	
(dv/dt)c	Critical Rate-of-rise of Commutation Voltage	(di/dt)c = 8.1 A/ms, $T_{vj} = 125\text{ }^\circ\text{C}$		4	–	–	V/ $\mu$ s
$t_{gt}$	Turn-on Time	$I_G = 2 \times I_{GT}$ , $P_W = 15\text{ }\mu\text{s}$ , $I_T = 22.6\text{ A}_{pk}$		–	4	–	$\mu$ s

**Electrical Characteristics** ( $T_{vj} = 25\text{ }^{\circ}\text{C}$ , unless otherwise specified) — **Alternistor TRIAC** (3 Quadrants)

Symbol	Characteristics	Conditions	Quadrant	Qxx16xH2	Qxx16xH3	Qxx16xH4	Qxx16xH6	Qxx15x6	Units	
$I_{GT}$	DC Gate Trigger Current	$V_D = 12\text{ V}, R_L = 60\ \Omega$	I – II – II	Max.	10	20	35	80	80	mA
$V_{GT}$	DC Gate Trigger Voltage		I – II – II	Max.	1.3					V
$V_{GD}$	Gate Non-trigger Voltage	$V_D = V_{DRM}, R_L = 3.3\text{ k}\Omega,$ $T_{vj} = 125\text{ }^{\circ}\text{C}$	I – II – II	Min.	0.2					V
$I_H$	Holding Current	$I_T = 100\text{ mA}$		Max.	15	35	50	70	70	mA
$dv/dt$	Critical Rate-of-rise of Off-stage Voltage	$V_D = V_{DRM},$ Gate Open, $T_{vj} = 125\text{ }^{\circ}\text{C}$	400 V	Min.	200	350	475	925	–	V/ $\mu\text{s}$
			600 V		150	250	400	850	600	
			800 V		100	200	350	475	–	
			$V_D = 2/3 V_{DRM},$ Gate Open, $T_{vj} = 100\text{ }^{\circ}\text{C}$		1000 V	100	200	300	350	
$(dv/dt)_c$	Critical Rate-of-rise of Commutation Voltage	$(di/dt)_c = 8.6\text{ A/ms},$ $T_{vj} = 125\text{ }^{\circ}\text{C}$		Min.	2	20	25	30	25	V/ $\mu\text{s}$
$t_{gt}$	Turn-on Time	$I_G = 2 \times I_{GT}, P_W = 15\ \mu\text{s},$ $I_T = 22.6\text{ A}_{pk}$		Typ.	3	3	3	5	5	$\mu\text{s}$

**Static Characteristics**

Symbol	Characteristics	Conditions	Maximum Value	Units		
$V_{TM}$	Peak On-state Voltage	15 A Device: $I_T = 21.2\text{ A } t_p = 380\ \mu\text{s}$	1.6	V		
		16 A Device: $I_T = 22.6\text{ A } t_p = 380\ \mu\text{s}$				
$I_{DRM}/I_{RRM}$	Off-state Current, Peak Repetitive	$V_D = V_{DRM}/V_{RRM}$	$T_{vj} = 25\text{ }^{\circ}\text{C}$	400-1000 V	5	$\mu\text{A}$
			$T_{vj} = 125\text{ }^{\circ}\text{C}$	400-800 V	2	mA
			$T_{vj} = 100\text{ }^{\circ}\text{C}$	1000 V	3	

**Thermal Characteristics**

Symbol	Characteristics	Value	Units	
$R_{thJC}$	Thermal Resistance, Junction to Case (AC)	Qxx15Ry/ Qxx15Ny/ Qxx16RHx/ Qxx16NHx	1.7	K/W
		Qxx15Ly/ Qxx16LHx	2.1	
$R_{thJA}$	Thermal Resistance, Junction to Ambient	Qxx15Ry/ Qxx16RHx	45	K/W
		Qxx15Ly/ Qxx16LHx	50	

xx = voltage/10; y = sensitivity

### Characteristic Curves

**Figure 1. Definition of Quadrants**

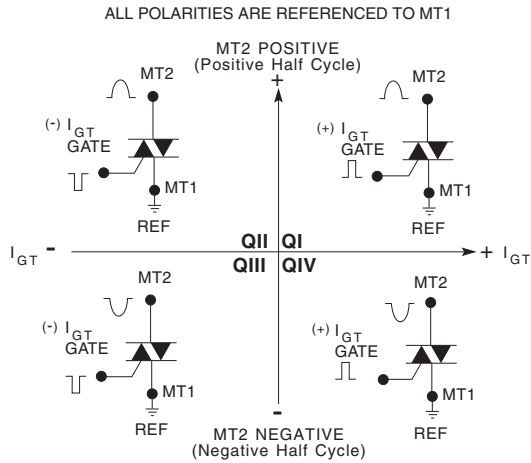

**Note:** Alternistors will not operate in QIV

**Fig. 2. Normalized DC Gate Trigger Current for all Quadrants vs. Junction Temperature**

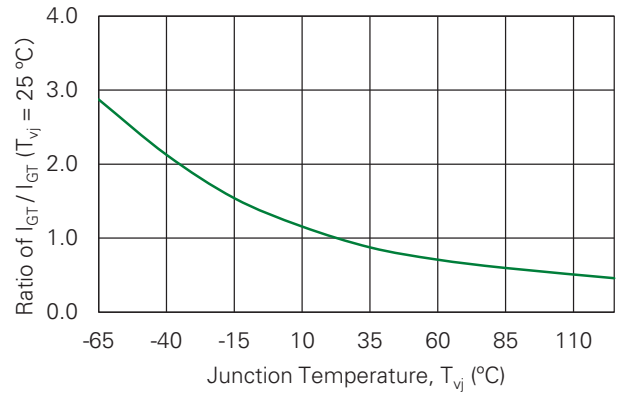

**Fig. 3. Normalized DC Holding Current vs. Junction Temperature**

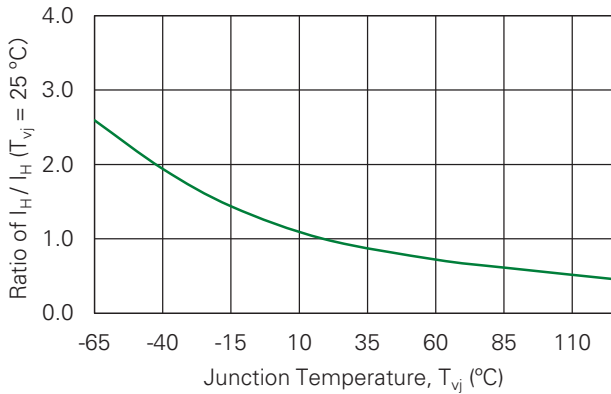

**Fig. 4. Normalized DC Gate Trigger Voltage for all Quadrants vs. Junction Temperature**

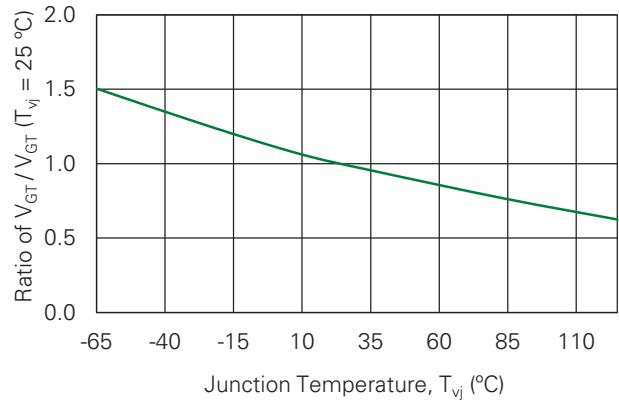

**Fig. 5. Typical Power Dissipation vs. RMS On-state Current**

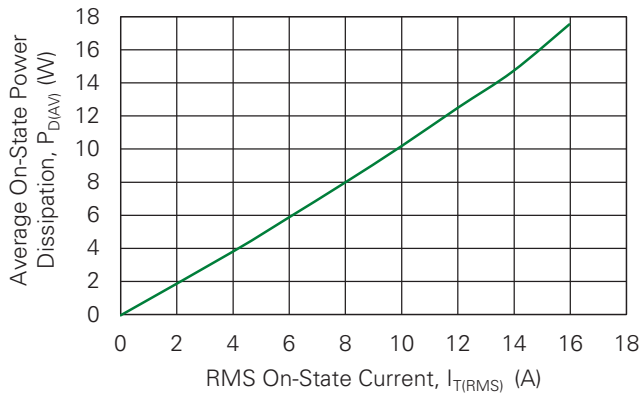

**Fig. 6. Maximum Allowable Case Temperature vs. On-state Current (15 A Devices)**

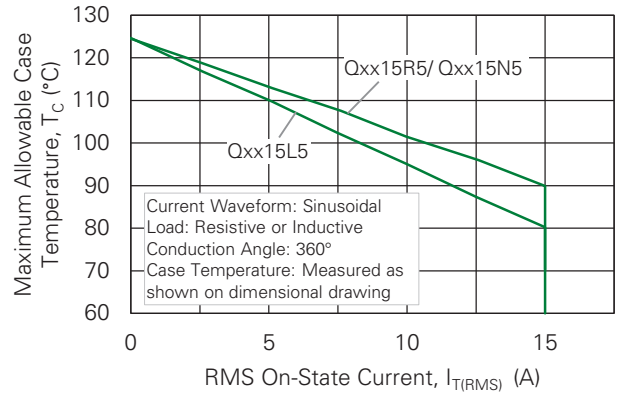

**Fig. 7. Maximum Allowable Case Temperature vs. On-state Current (16 A Devices)**

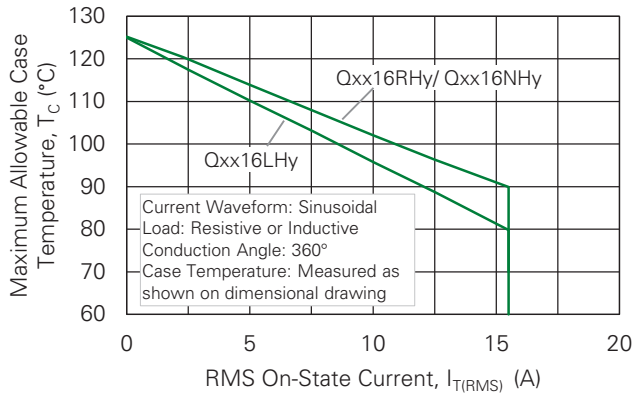

**Fig. 8. Maximum Allowable Ambient Temperature vs. On-state Current**

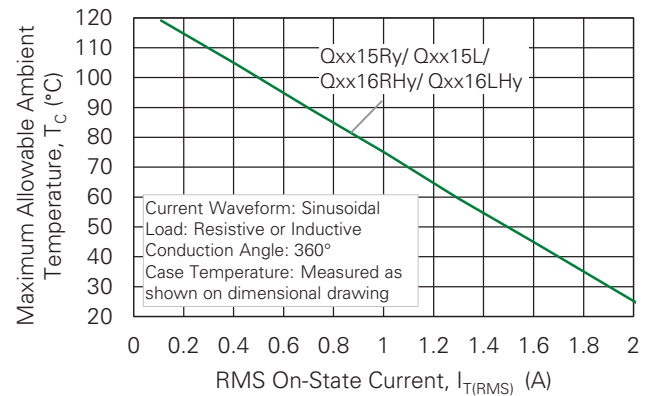

**Fig. 9. Typical On-state Current vs. On-state Voltage**

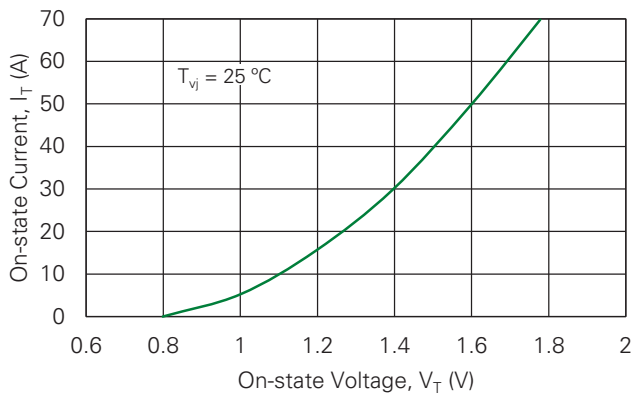

**Fig. 10. Surge Peak On-state Current vs. Number of Cycles**

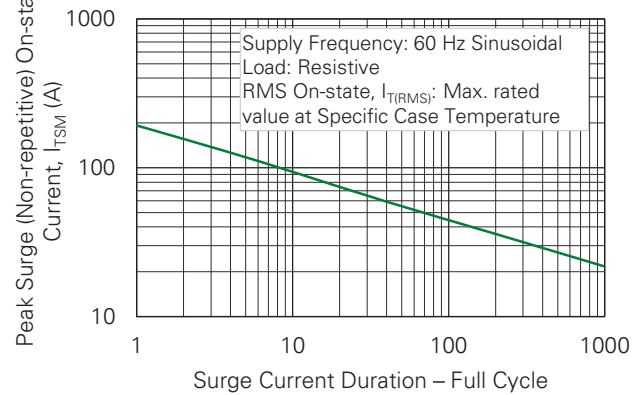

Notes:

1. Gate control may be lost during and immediately following surge current interval.
2. Overload may not be repeated until junction temperature has returned to steady-state rated value.

### Soldering Parameters

Characteristic		Value
Reflow Condition		Pb – Free assembly
Pre-heat	Temperature Min ( $T_{s(min)}$ )	150 °C
	Temperature Max ( $T_{s(max)}$ )	200 °C
	Time (min to max) ( $t_s$ )	60 – 180 secs
Average ramp up rate (Liquidus Temp)( $T_L$ ) to peak		5 °C/second max
$T_{s(max)}$ to $T_L$ - Ramp-up Rate		5 °C/second max
Reflow	Temperature ( $T_L$ ) (Liquidus)	217 °C
	Time ( $t_L$ )	60 – 150 seconds
Peak Temperature ( $T_p$ )		260 <sup>+0/-5</sup> °C
Time within 5 °C of actual peak Temperature ( $t_p$ )		20 – 40 seconds
Ramp-down Rate		5 °C/second max
Time 25 °C to peak Temperature ( $T_p$ )		8 minutes max
Do Not Exceed		280 °C

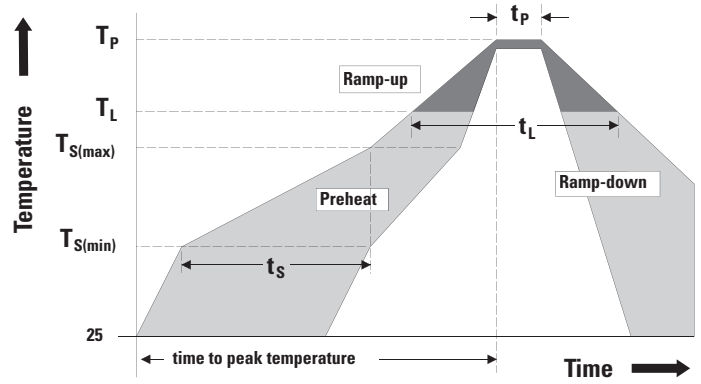

### Physical Specifications

Characteristic	Value
Terminal Finish	100% Matte Tin-plated
Body Material	UL Recognized compound meeting flammability rating V-0
Terminal Material	Copper Alloy

### Design Considerations

Careful selection of the correct component for the application’s operating parameters and environment will go a long way toward extending the operating life of the Thyristor. Good design practice should limit the maximum continuous current through the main terminals to 75% of the component rating. Other ways to ensure long life for a power discrete semiconductor are proper heat sinking and selection of voltage ratings for worst case conditions. Overheating, overvoltage (including dv/dt), and surge currents are the main killers of semiconductors. Correct mounting, soldering, and forming of the leads also help protect against component damage.

### Packing Options

Part Number	Marking	Weight	Packing Mode	Base Quantity
Qxx15L/RyTP	Qxx15L/Ry	2.2 g	Tube Pack	1000 (50 per tube)
Qxx15NyTP	Qxx15Ny	1.6 g	Tube	1000 (50 per tube)
Qxx15NyRP	Qxx15Ny	1.6 g	Embossed Carrier	500
Qxx16L/RHyTP	Qxx16L/RHy	2.2 g	Tube Pack	1000 (50 per tube)
Qxx16NHyTP	Qxx16NHy	1.6 g	Tube	1000 (50 per tube)
Qxx16NHyRP	Qxx16NHy	1.6 g	Embossed Carrier	500

xx = voltage/10; y = sensitivity

### Environmental Specifications

Test	Specifications and Conditions
AC Blocking	MIL-STD-750, M-1040, Cond A Applied Peak AC voltage @ 125 °C for 1008 hours
Temperature Cycling	MIL-STD-750, M-1051, 100 cycles; -40 °C to +150 °C; 15-min dwell-time
Temperature/Humidity	EIA / JEDEC, JESD22-A101, 1008 hours; 320 V - DC: 85 °C; 85% relative humidity
High Temperature Storage	MIL-STD-750, M-1031, 1008 hours; 150 °C
Low Temperature Storage	1008 hours; -40 °C
Resistance to Solder Heat	MIL-STD-750: Method 2031
Solderability	ANSI/J-STD-002: category 3, Test A
Lead Bend	MIL-STD-750, M-2036 Cond E

**Product Selector**

Part Number	Voltage				Gate Sensitivity Quadrants	Type	Package
	400 V	600 V	800 V	1000 V	I-II-III		
Qxx15L5	X	X	X	X	50 mA	Standard TRIAC	TO-220AB (L package)
Qxx15R5	X	X	X	X	50 mA	Standard TRIAC	TO-220AB (R package)
Qxx15N5	X	X	X	X	50 mA	Standard TRIAC	TO-263 (D <sup>2</sup> PAK)
Qxx15L6	-	X	-	-	80 mA	Alternistor TRIAC	TO-220AB (L package)
Qxx16LH2	X	X	X	X	10 mA	Alternistor TRIAC	TO-220AB (L package)
Qxx16RH2	X	X	X	X	10 mA	Alternistor TRIAC	TO-220AB (R package)
Qxx16NH2	X	X	X	X	10 mA	Alternistor TRIAC	TO-263 (D <sup>2</sup> PAK)
Qxx16LH3	X	X	X	X	20 mA	Alternistor TRIAC	TO-220AB (L package)
Qxx16RH3	X	X	X	X	20 mA	Alternistor TRIAC	TO-220AB (R package)
Qxx16NH3	X	X	X	X	20 mA	Alternistor TRIAC	TO-263 (D <sup>2</sup> PAK)
Qxx16LH4	X	X	X	X	35 mA	Alternistor TRIAC	TO-220AB (L package)
Qxx16RH4	X	X	X	X	35 mA	Alternistor TRIAC	TO-220AB (R package)
Qxx16NH4	X	X	X	X	35 mA	Alternistor TRIAC	TO-263 (D <sup>2</sup> PAK)
Qxx16LH6	X	X	X	X	80 mA	Alternistor TRIAC	TO-220AB (L package)
Qxx16RH6	X	X	X	X	80 mA	Alternistor TRIAC	TO-220AB (R package)
Qxx16NH6	X	X	X	X	80 mA	Alternistor TRIAC	TO-263 (D <sup>2</sup> PAK)

**Part Numbering and Marking**

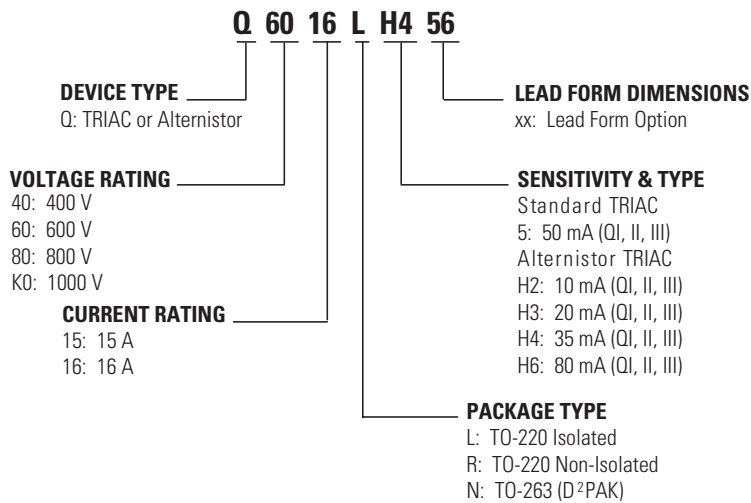

**TO-220 AB - (L and R Package)**  
**TO-263 AB - (N Package)**

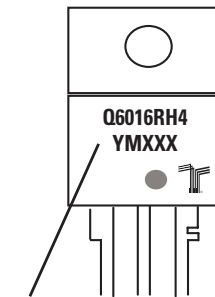

Date Code Marking  
Y: Year Code  
M: Month Code  
XXX: Lot Trace Code

Package Dimensions TO-220AB (L Package) – Isolated Mounting Tab

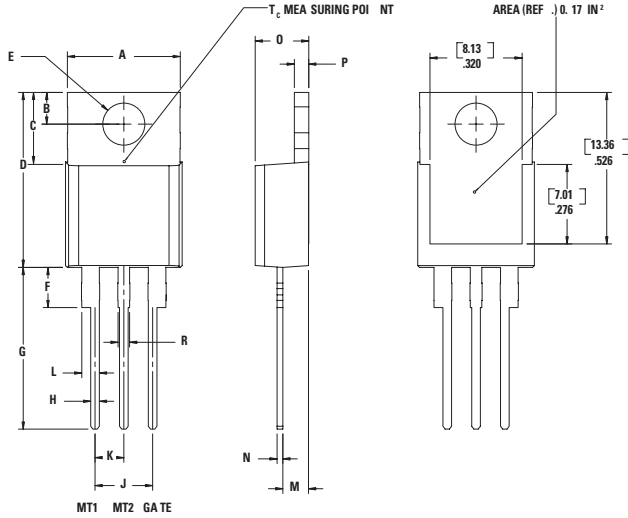

**Note:** Maximum torque to be applied to mounting tab is 8 in-lbs. (0.904 Nm).

Symbol	Millimeters		Inches	
	Min.	Max.	Min.	Max
A	9.65	10.67	0.380	0.420
B	2.67	2.92	0.105	0.115
C	5.84	6.35	0.230	0.250
D	14.99	15.75	0.590	0.620
E	3.61	3.73	0.142	0.147
F	2.79	3.30	0.110	0.130
G	13.72	14.60	0.540	0.575
H	0.64	0.89	0.025	0.035
J	4.95	5.21	0.195	0.205
K	2.41	2.67	0.095	0.105
L	1.52	1.91	0.060	0.075
M	2.16	2.41	0.085	0.095
N	0.46	0.61	0.018	0.024
O	4.52	4.78	0.178	0.188
P	1.14	1.52	0.045	0.060
R	0.97	1.22	0.038	0.048

Package Dimensions TO-220AB (R Package) – Non-isolated Mounting Tab Common with Center Lead

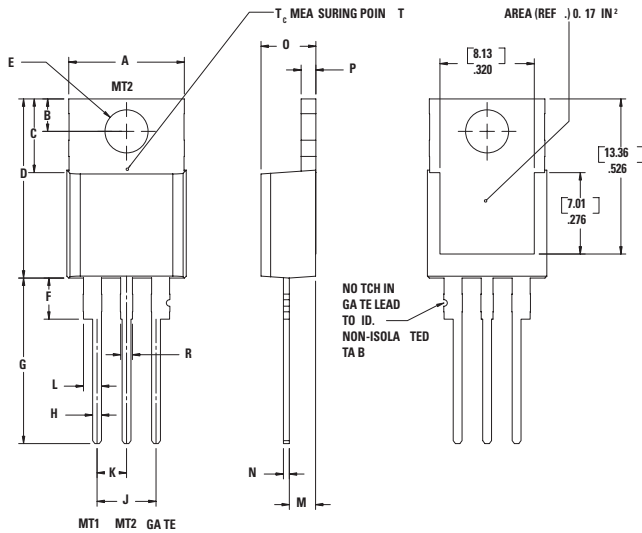

**Note:** Maximum torque to be applied to mounting tab is 8 in-lbs. (0.904 Nm).

Symbol	Millimeters		Inches	
	Min.	Max.	Min.	Max
A	9.65	10.67	0.380	0.420
B	2.67	2.92	0.105	0.115
C	5.84	6.35	0.230	0.250
D	14.99	15.75	0.590	0.620
E	3.61	3.73	0.142	0.147
F	2.79	3.30	0.110	0.130
G	13.72	14.60	0.540	0.575
H	0.64	0.89	0.025	0.035
J	4.95	5.21	0.195	0.205
K	2.41	2.67	0.095	0.105
L	1.52	1.91	0.060	0.075
M	2.16	2.41	0.085	0.095
N	0.46	0.61	0.018	0.024
O	4.52	4.78	0.178	0.188
P	1.14	1.52	0.045	0.060
R	0.97	1.22	0.038	0.048



**Package Dimensions** TO-263 (N Package) – D<sup>2</sup>PAK Surface Mount

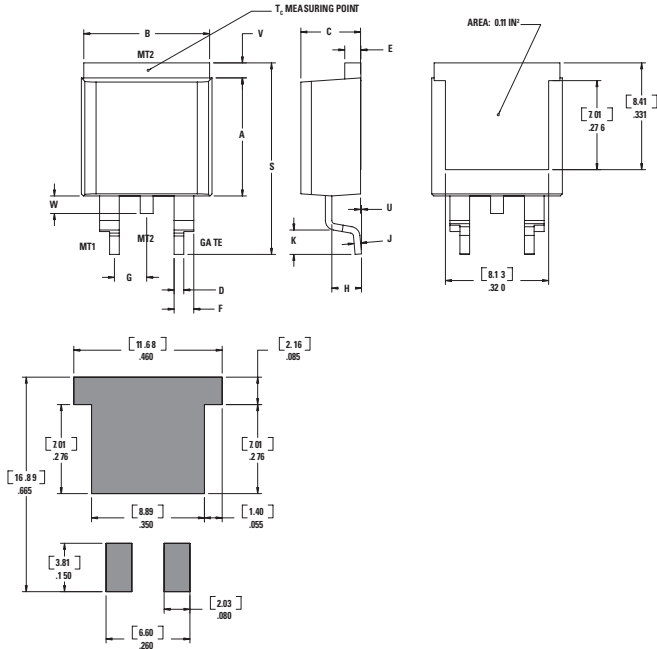

Symbol	Millimeters		Inches	
	Min.	Max.	Min.	Max
A	9.14	9.40	0.360	0.370
B	9.65	10.67	0.380	0.420
C	4.52	4.78	0.178	0.188
D	0.64	0.89	0.025	0.035
E	1.14	1.52	0.045	0.060
F	1.52	1.91	0.060	0.075
G	2.41	2.67	0.095	0.105
H	2.34	2.59	0.092	0.102
J	0.46	0.61	0.018	0.024
K	2.29	2.79	0.090	0.110
S	14.99	15.88	0.590	0.625
V	0.89	1.14	0.035	0.045
U	0.05	0.25	0.002	0.010
W	1.02	1.78	0.040	0.070

**Reel Pack (RP) Specifications for TO-263 Embossed Carrier**

Meets all EIA-481-2 Standards

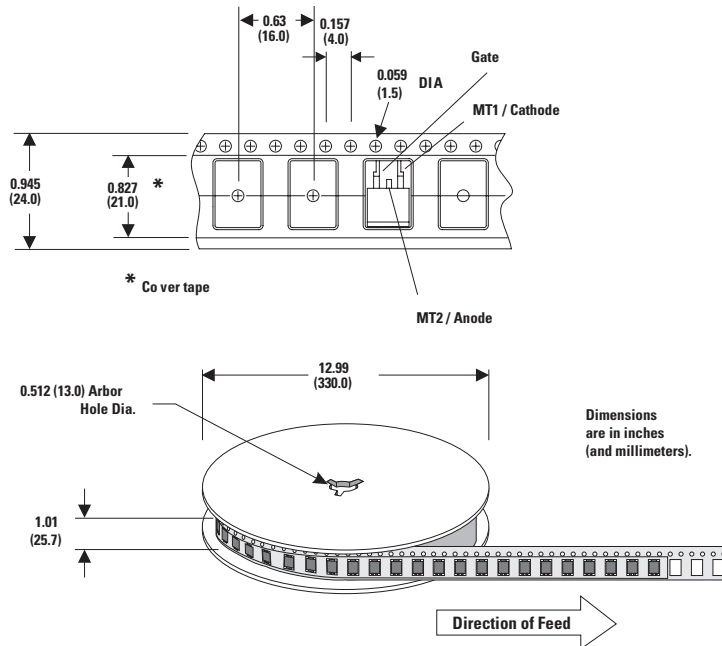

**Disclaimer Notice**

Information furnished is believed to be accurate and reliable. However, users should independently evaluate the suitability of and test each product selected for their own applications. Littelfuse products are not designed for, and may not be used in, all applications. Read complete Disclaimer Notice at <http://www.littelfuse.com/disclaimer-electronics>.



Part of:

