

**AQ3530-01LTG**

0.3pF 22kV unidirectional TVS diode

**Description**

This AQ3530 unidirectional diode provides a high level of protection for electronic equipment that may be exposed to electrostatic discharges (ESD). This robust component can safely absorb repetitive ESD strikes above the maximum level specified in the IEC 61000-4-2 international standard (Level 4,  $\pm 8\text{kV}$  contact discharge) without performance degradation. The extremely low loading capacitance also makes it ideal for protecting high speed signal pins such as V-By-One®, HDMI, USB3.0, USB2.0, and IEEE 1394.

**Features & Benefits**

- ESD, IEC 61000-4-2,  $\pm 22\text{kV}$  contact,  $\pm 30\text{kV}$  air
- EFT, IEC 61000-4-4, 40A (tP=5/50ns)
- Lightning, 2.5A (8/20 $\mu\text{s}$  as defined in IEC 61000-4-5 2<sup>nd</sup> edition)
- Low capacitance of 0.3pF (TYP) at 3GHz
- ESD, ISO 10605, 330pF 330 $\Omega$ ,  $\pm 26\text{kV}$  contact,  $\pm 30\text{kV}$  air
- Facilitates excellent signal integrity
- PPAP capable
- AEC-Q101 qualified
- Halogen free, Lead free and RoHS compliant
- Moisture Sensitivity Level (MSL -1)

**Additional Information**

Resources



Accessories

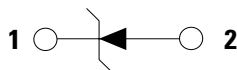

Samples

**Pinout****Functional Block Diagram****Applications**

- Ultra-high speed data lines
- USB 3.1, 3.0, 2.0
- HDMI 2.0, 1.4a, 1.3
- DisplayPort(TM)
- V-by-One®
- LVDS interfaces
- Automotive application
- Consumer, mobile and portable electronics
- Tablet PC and external storage with high speed interfaces
- Applications requiring high ESD performance in small packages

**AQ3530-01LTG**

0.3pF 22kV unidirectional TVS diode

**Absolute Maximum Ratings**

Symbol	Parameter	Value	Units
$I_{PP}$	Peak Current ( $t_p=8/20\mu s$ )	2.5	A
$T_{OP}$	Operating Temperature	-40 to 150	°C
$T_{STOR}$	Storage Temperature	-55 to 150	°C

**Caution:** Stresses above those listed in "Absolute Maximum Ratings" may cause permanent damage to the component. This is a stress only rating and operation of the component at these or any other conditions above those indicated in the operational sections of this specification is not implied.

**Electrical Characteristics - ( $T_{OP}=25^\circ C$ )**

Parameter	Symbol	Test Conditions	Min	Typ	Max	Units
Reverse Standoff Voltage	$V_{RWM}$	$I_R=1\mu A$			5	V
Breakdown Voltage	$V_{BR}$	$I_R=1mA$	7.5	8.5		V
Reverse Leakage Current	$I_{LEAK}$	$V_R=5V$		0.02	0.1	$\mu A$
Clamp Voltage <sup>1</sup>	$V_C$	$I_{pp}=2.5A$ , $t_p=8/20\mu s$ , I/O to GND		12.5	15	V
Dynamic Resistance <sup>2</sup>	$R_{DYN}$	TLP, $t_p=100ns$ , I/O to GND		0.78		$\Omega$
ESD Withstand Voltage <sup>1</sup>	$V_{ESD}$	IEC 61000-4-2 (Contact)	$\pm 22$			kV
		IEC 61000-4-2 (Air)	$\pm 30$			kV
Diode Capacitance <sup>1,3</sup>	$C_{I/O-GND}$	Reverse Bias=0V, $f=3GHz$		0.30		pF

**Note:**

- Parameter is guaranteed by design and/or component characterization.
- Transmission Line Pulse (TLP) with 100ns width, 2ns rise time, and average window  $t_1=70ns$  to  $t_2=90ns$ .
- Package sizes larger than 0201 can add parasitic capacitance, inductance and resistance.

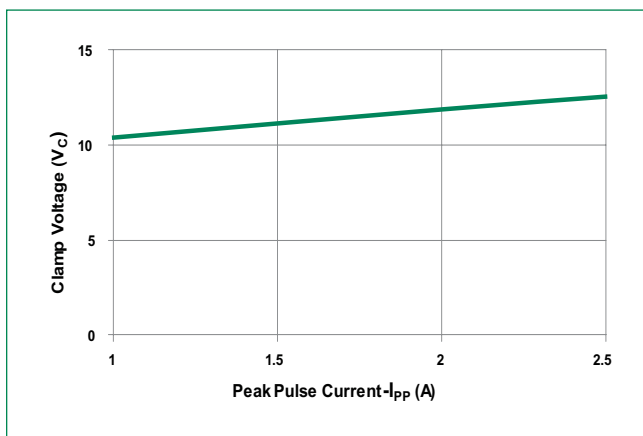
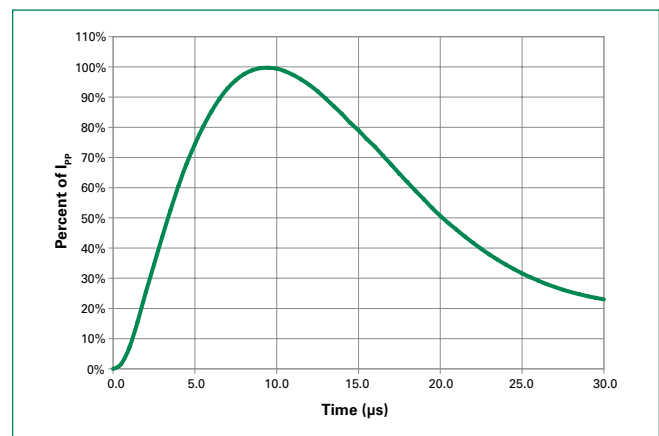
**Clamping voltage vs. IPP for 8/20 $\mu s$  waveshape****8/20 $\mu s$  Pulse Waveform**

# AQ3530-01LTG

0.3pF 22kV unidirectional TVS diode

Positive Transmission Line Pulsing (TLP) Plot

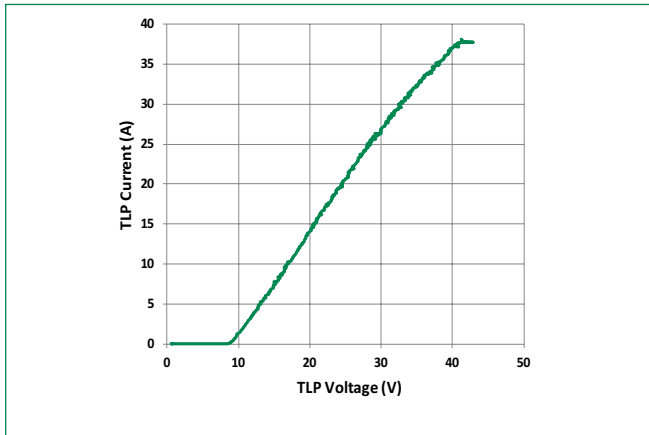

Negative Transmission Line Pulsing (TLP) Plot

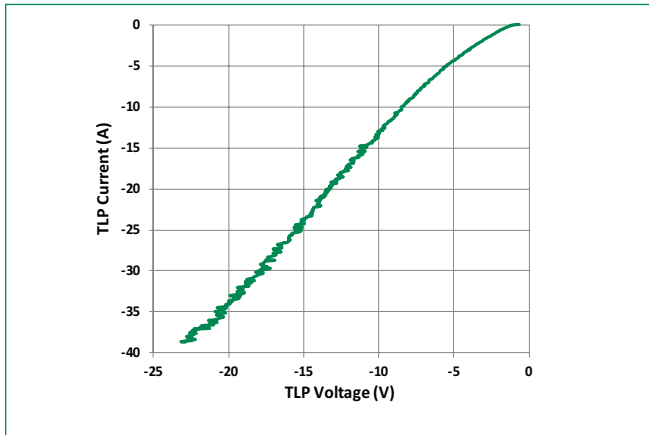

IEC 61000-4-2 +8 kV Contact ESD Clamping Voltage

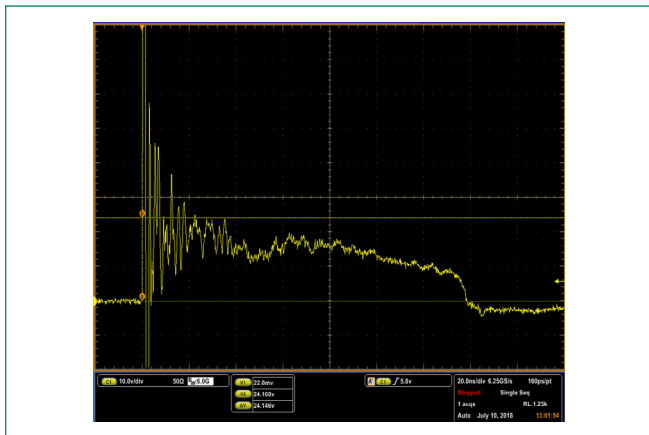

IEC 61000-4-2 -8 kV Contact ESD Clamping Voltage

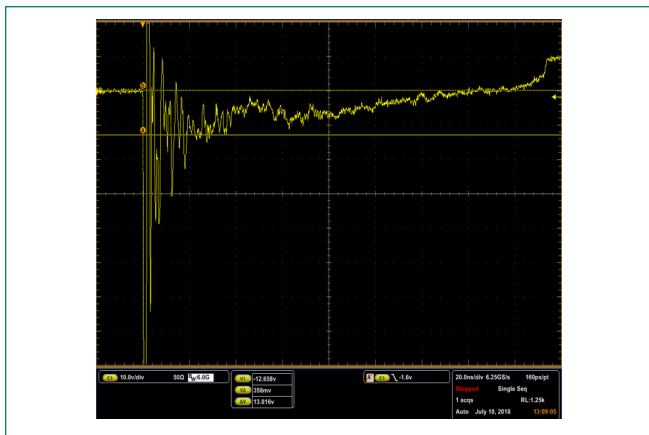

ESD ISO10605 +8 kV Contact ESD Clamping Voltage

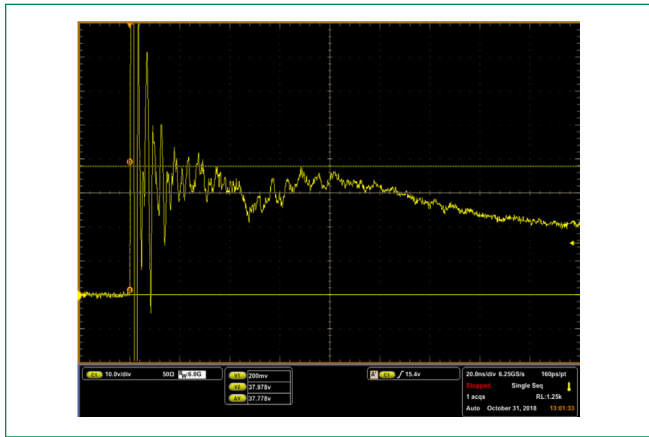

ESD ISO10605 -8 kV Contact ESD Clamping Voltage

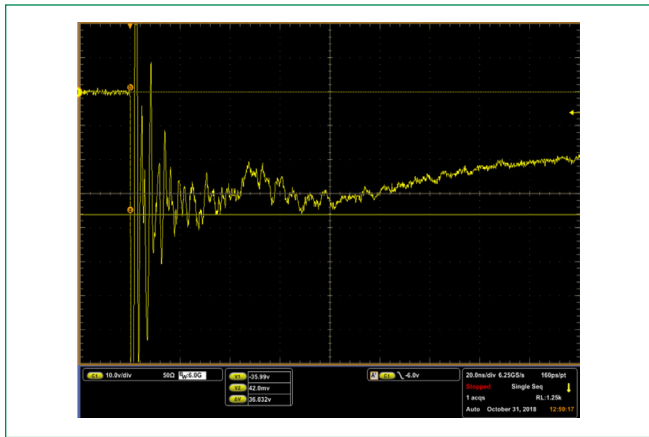

**AQ3530-01LTG**

0.3pF 22kV unidirectional TVS diode

**Soldering Parameters**

<b>Reflow Condition</b>		Pb – Free assembly
<b>Pre Heat</b>	- Temperature Min ( $T_{s(min)}$ )	150°C
	- Temperature Max ( $T_{s(max)}$ )	200°C
	- Time (min to max) ( $t_s$ )	60 – 120 secs
<b>Average ramp up rate (Liquidus) Temp (<math>T_L</math>) to peak</b>		3°C/second max
<b><math>T_{S(max)}</math> to <math>T_L</math> - Ramp-up Rate</b>		3°C/second max
<b>Reflow</b>	- Temperature ( $T_L$ ) (Liquidus)	217°C
	- Temperature ( $t_l$ )	60 – 150 seconds
<b>Peak Temperature (<math>T_p</math>)</b>		260 <sup>+0/-5</sup> °C
<b>Time within 5°C of actual peak Temperature (<math>t_p</math>)</b>		30 seconds
<b>Ramp-down Rate</b>		6°C/second max
<b>Time 25°C to peak Temperature (<math>T_p</math>)</b>		8 minutes Max.
<b>Do not exceed</b>		260°C

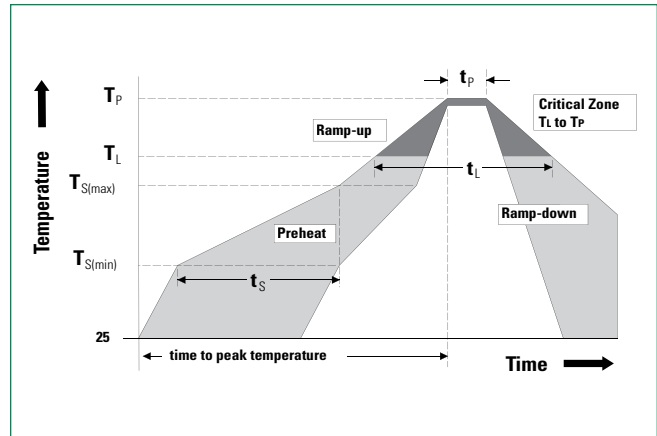
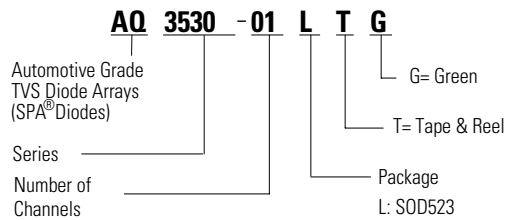
**Part Numbering System****Product Characteristics**

<b>Lead Plating</b>	Matte Tin
<b>Lead Material</b>	Copper Alloy
<b>Lead Coplanarity</b>	0.004 inches(0.102mm)
<b>Substrate Material</b>	Silicon
<b>Body Material</b>	Molded Compound
<b>Flammability</b>	UL Recognized compound meeting flammability rating V-0

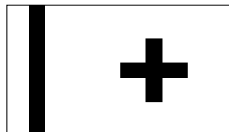
**Part Marking System****Ordering Information**

Part Number	Package	Min. Order Qty.
AQ3530-01LTG	SOD523	5000

# AQ3530-01LTG

0.3pF 22kV unidirectional TVS diode

## Package Dimensions – SOD-523

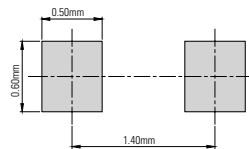
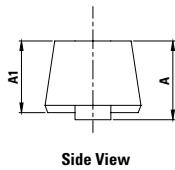
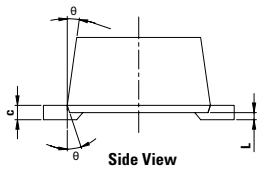
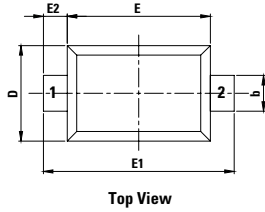

Drawing#: L01-B

Symbol	Millimeters		Inches	
	Min	Max	Min	Max
<b>A</b>	0.51	0.77	0.020	0.030
<b>A1</b>	0.50	0.70	0.020	0.028
<b>b</b>	0.25	0.35	0.010	0.014
<b>c</b>	0.08	0.15	0.003	0.006
<b>D</b>	0.70	0.90	0.028	0.035
<b>E</b>	1.10	1.30	0.043	0.051
<b>E1</b>	1.50	1.70	0.059	0.067
<b>E2</b>	0.20 REF		0.001 REF	
<b>L</b>	0.01	0.07	0.000	0.003
$\theta$	7° REF		7° REF	

## Embossed Carrier Tape & Reel Specification – SOD-523

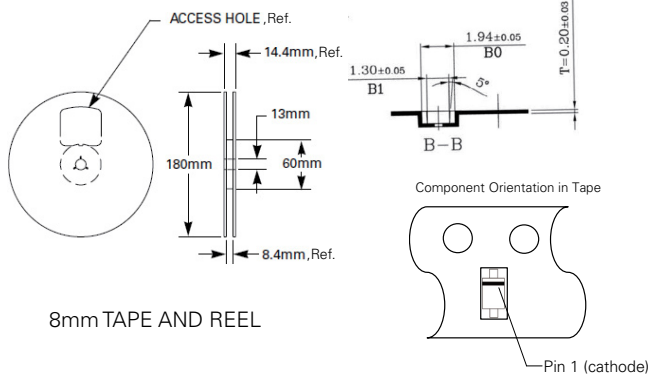
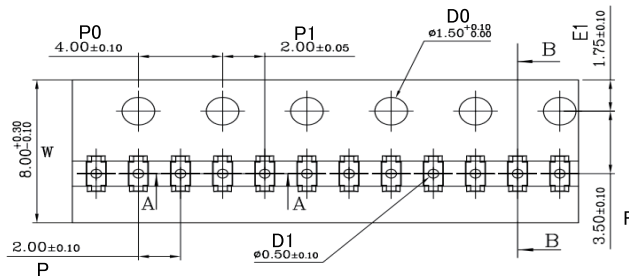

Symbol	Millimeters		Inches	
	Min	Max	Min	Max
<b>A0</b>	0.91	1.01	0.036	0.040
<b>B0</b>	1.89	1.99	0.074	0.078
<b>D0</b>	1.50	1.60	0.059	0.063
<b>D1</b>	0.40	0.60	0.016	0.024
<b>E1</b>	1.65	1.85	0.065	0.073
<b>F</b>	3.40	3.60	0.134	0.142
<b>P0</b>	3.90	4.10	0.154	0.161
<b>P</b>	1.90	2.10	0.075	0.083
<b>P1</b>	1.95	2.05	0.077	0.081
<b>K0</b>	0.68	0.78	0.027	0.031
<b>T</b>	0.17	0.23	0.007	0.009
<b>W</b>	7.90	8.30	0.311	0.327

**Disclaimer Notice** - Information furnished is believed to be accurate and reliable. However, users should independently evaluate the suitability of and test each product selected for their own applications. Littelfuse products are not designed for, and may not be used in, all applications. Read complete Disclaimer Notice at <http://www.littelfuse.com/disclaimer-electronics>.