

AQ3041 Series

Low Capacitance ESD Protection



Pinout

SOD882

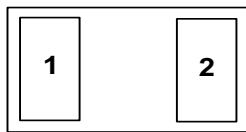

Functional Block Diagram

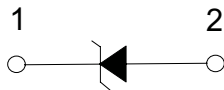

Life Support Note:

Not Intended for Use in Life Support or Life Saving Applications

The products shown herein are not designed for use in life sustaining or life saving applications unless otherwise expressly indicated.

Description

The AQ3041 low capacitance rail to rail diode provides protection for electronic equipment that may experience destructive electrostatic discharges (ESD). This robust diode can safely absorb repetitive ESD strikes above the maximum level specified in IEC 61000-4-2 international standard ($\pm 20\text{kV}$ contact discharge) without performance degradation. The low loading capacitance makes it ideal for protecting high speed data lines such as HDMI, DVI, USB2.0, USB3.0 and eSATA.

Features

- ESD protection of $\pm 20\text{kV}$ contact discharge, $\pm 30\text{kV}$ air discharge, (IEC 61000-4-2)
- EFT protection, IEC 61000-4-4, 40A ($t_p=5/50\text{ns}$)
- Lightning, 3A (8/20 as defined in IEC 61000-4-5 2nd edition)
- PPAP capable
- Low capacitance of 0.5pF @ $\text{VR}=0\text{V}$
- Low leakage current of $0.1\mu\text{A}$ at 5V
- Small SOD882 packaging helps save board space
- AEC-Q101 qualified
- Halogen free, lead free and RoHS compliant
- Moisture Sensitivity Level(MSL -1)

Applications

- Tablets
- Ultrabook
- eReader
- Smart Phones
- Digital Cameras
- MP3/ PMP
- Set Top Boxes
- Portable Medical
- Automotive applications

HDMI Application Example

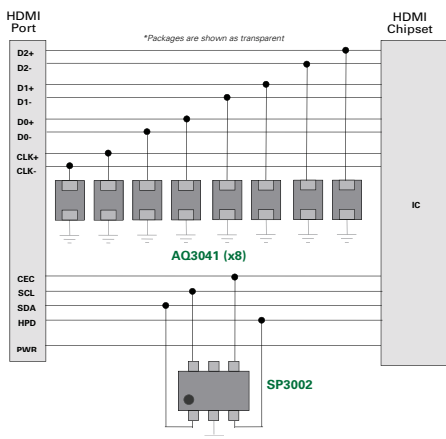

USB3.0 Application Example

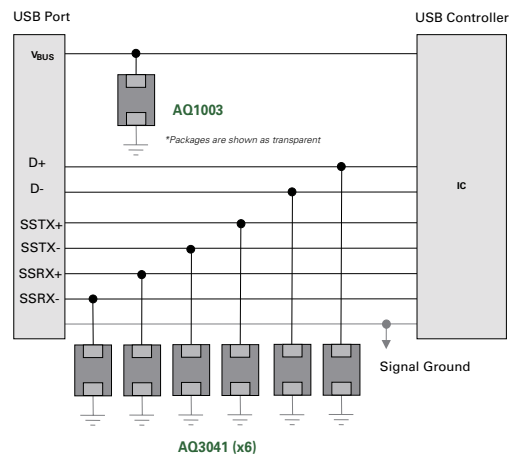

AQ3041 Series

Low Capacitance ESD Protection

Absolute Maximum Ratings

Symbol	Parameter	Value	Units
I_{PP}	Peak Current ($t_p=8/20\mu s$)	3.0	A
T_{OP}	Operating Temperature	-40 to 150	°C
T_{STOR}	Storage Temperature	-55 to 150	°C

Caution: Stresses above those listed in "Absolute Maximum Ratings" may cause permanent damage to the component. This is a stress only rating and operation of the component at these or any other conditions above those indicated in the operational sections of this specification is not implied.

Electrical Characteristics ($T_{OP}=25^\circ C$)

Parameter	Symbol	Test Conditions	Min	Typ	Max	Units
Reverse Standoff Voltage	V_{RWM}	IR=1 μ A	-	-	5	V
Reverse Leakage Current	I_{LEAK}	$V_R=5V$ with 1 pin at GND	-	0.1	0.5	μ A
Clamp Voltage ¹	V_C	$I_{PP}=1A$, $t_p=8/20\mu s$, Fwd	-	9.2	-	V
		$I_{PP}=2A$, $t_p=8/20\mu s$, Fwd	-	10.0	-	V
ESD Withstand Voltage ¹	V_{ESD}	IEC 61000-4-2 (Contact)	± 20	-	-	kV
		IEC 61000-4-2 (Air)	± 30	-	-	kV
Dynamic Resistance ²	R_{DYN}	TLP, $t_p=100ns$, I/O to GND	-	0.3	-	Ω
Diode Capacitance ¹	$C_{I/O-GND}$	Reverse Bias=0V, f=1 MHz	-	0.5	-	pF

Note:

¹ Parameter is guaranteed by design and/or component characterization.

² Transmission Line Pulse (TLP) with 100ns width, 2ns rise time, and average window $t_1=70ns$ to $t_2=90ns$

Normalized Capacitance vs. Reverse Voltage

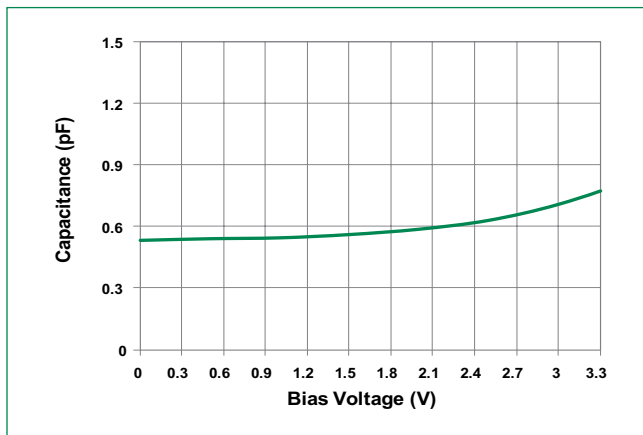

8/20 μs Pulse Waveform

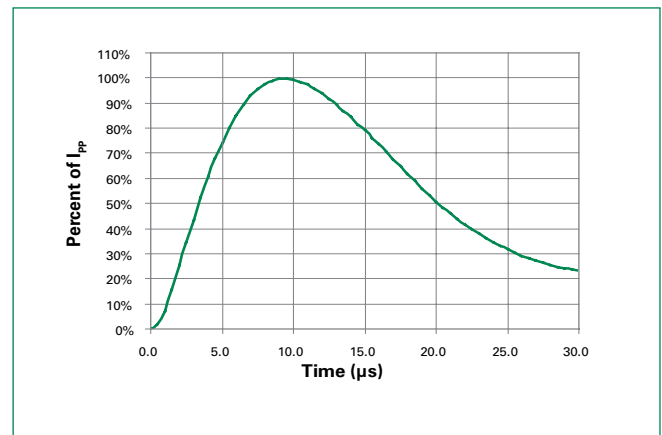

Transmission Line Pulsing (TLP) Plot

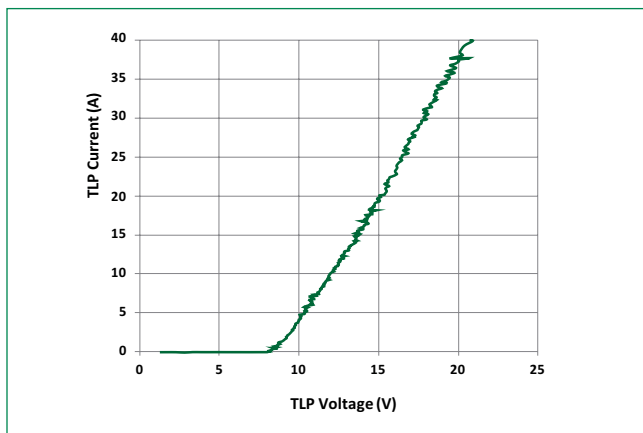

AQ3041 Series

Low Capacitance ESD Protection

Soldering Parameters

Reflow Condition		Pb – Free assembly
Pre Heat	- Temperature Min ($T_{s(min)}$)	150°C
	- Temperature Max ($T_{s(max)}$)	200°C
	- Time (min to max) (t_s)	60 – 120 secs
Average ramp up rate (Liquidus) Temp (T_L) to peak		3°C/second max
$T_{s(max)}$ to T_L - Ramp-up Rate		3°C/second max
Reflow	- Temperature (T_L) (Liquidus)	217°C
	- Temperature (t_L)	60 – 150 seconds
Peak Temperature (T_p)		260 ^{+0/-5} °C
Time within 5°C of actual peak Temperature (t_p)		30 seconds
Ramp-down Rate		6°C/second max
Time 25°C to peak Temperature (T_p)		8 minutes Max.
Do not exceed		260°C

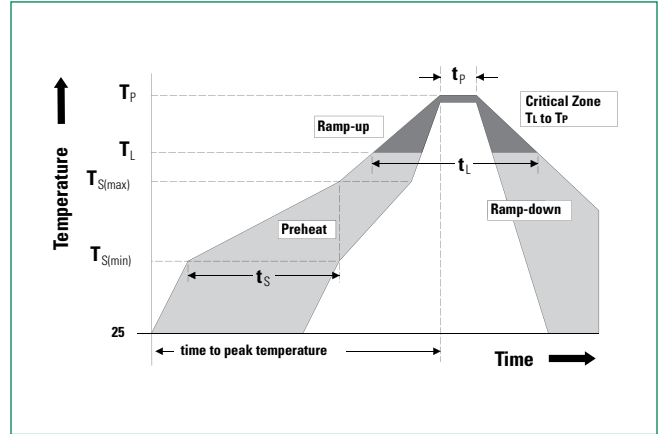

Part Numbering System

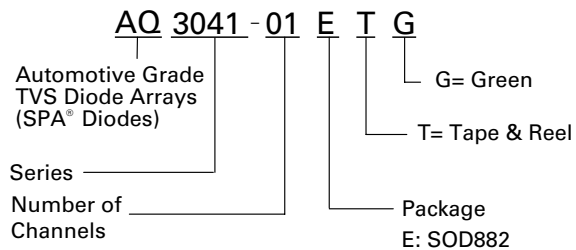

Product Characteristics

Lead Plating	Pre-Plated Frame
Lead Material	Copper Alloy
Substrate material	Silicon
Body Material	Molded Compound
Flammability	UL Recognized compound meeting flammability rating V-0

Ordering Information

Part Number	Package	Min. Order Qty.
AQ3041-01ETG	SOD882	10000

Part Marking System

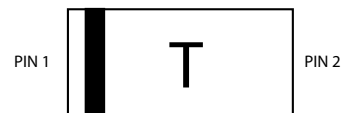

AQ3041 Series

Low Capacitance ESD Protection

Package Dimensions – SOD882

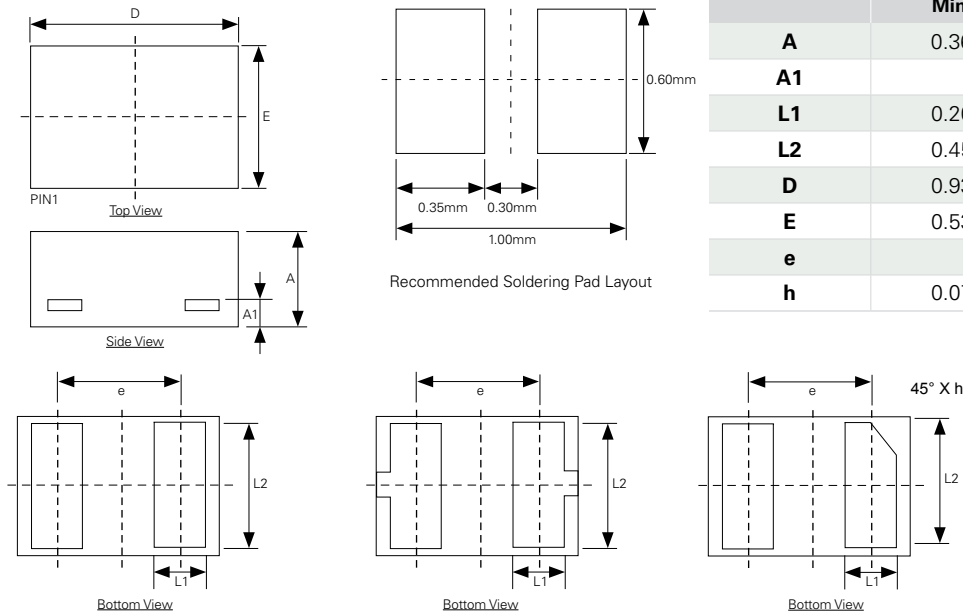

Symbol	DIMENSIONS (mm)		
	Min.	Nor.	Max.
A	0.36	0.45	0.55
A1	0.127 REF		
L1	0.20	0.25	0.30
L2	0.45	0.50	0.55
D	0.93	1.00	1.07
E	0.53	0.60	0.67
e	0.65 BSC		
h	0.07	0.12	0.17

Embossed Carrier Tape & Reel Specification – SOD882

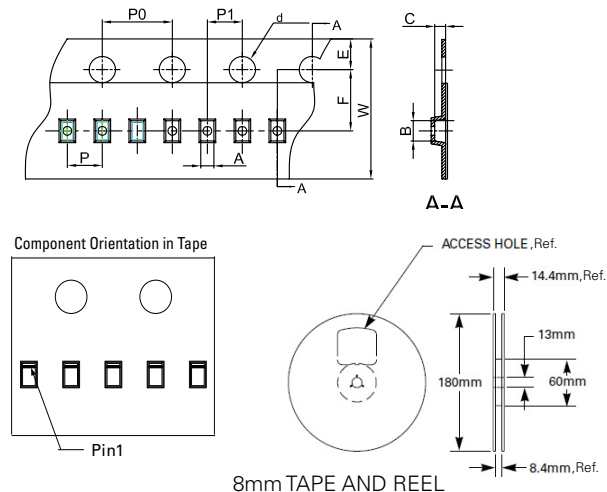

Symbol	Millimetres		Inches	
	Min	Max	Min	Max
A	0.65	0.70	0.026	0.028
B	1.10	1.20	0.043	0.047
C	0.50	0.60	0.020	0.024
d \varnothing	1.40	1.60	0.055	0.063
E	1.65	1.85	0.065	0.073
F	3.40	3.60	0.134	0.142
P0	3.90	4.10	0.154	0.161
P	1.90	2.10	0.075	0.083
P1	1.90	2.10	0.075	0.083
W	7.90	8.10	0.311	0.319

Disclaimer Notice - Information furnished is believed to be accurate and reliable. However, users should independently evaluate the suitability of and test each product selected for their own applications. Littelfuse products are not designed for, and may not be used in, all applications. Read complete Disclaimer Notice at <http://www.littelfuse.com/disclaimer-electronics>.