

SP1255P Series 0.5pF, 12kV Diode Array for μUSB

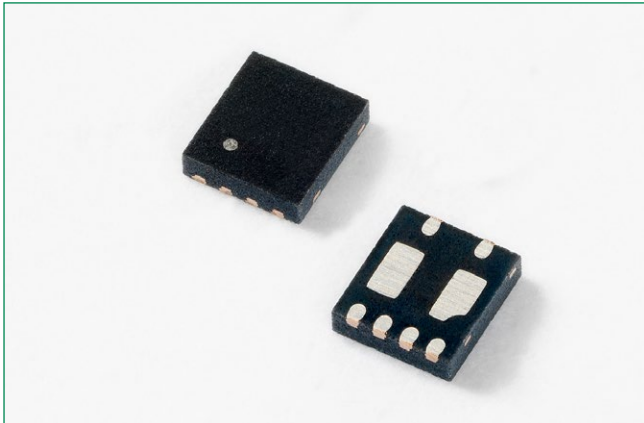

Pinout

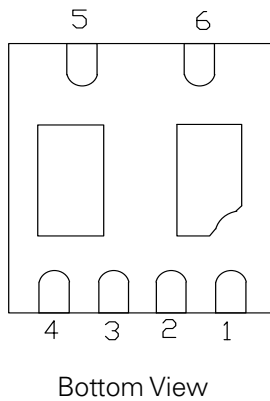

Functional Block Diagram

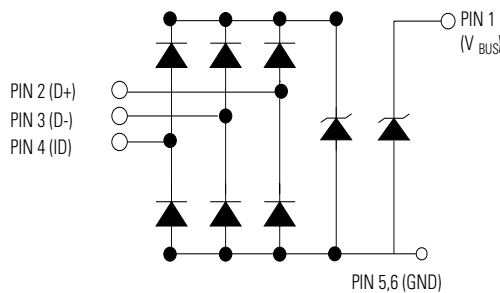

Life Support Note:

Not Intended for Use in Life Support or Life Saving Applications

The products shown herein are not designed for use in life sustaining or life saving applications unless otherwise expressly indicated.

Description

The SP1255P integrates three channels of ultra-low capacitance steering diodes and a low voltage TVS diode to provide maximum protection of the USB data and ID pins against ESD per the IEC 61000-4-2 standard. An additional 12V TVS diode is included to provide lightning surge protection for the USB V_{BUS} pin up to 100A ($t_p=8/20\mu s$) per the IEC 61000-4-5 standard. The SP1255P provides superior protection for current intensive applications such as fast charging peripherals.

The SP1255P comes in a space saving 2.0x1.8mm μ DFN package with a typical height of 0.55mm making it an ideal solution for smart phones, tablets, and other portable electronics.

Features

- RoHS compliant and lead-free
- AEC-101 qualified

For USB Voltage Bus Pin (V_{BUS})

- ESD, IEC 61000-4-2, $\pm 30kV$ contact, $\pm 30kV$ air
- EFT, IEC 61000-4-4, 80A ($t_p=5/50ns$)
- Lightning, IEC 61000-4-5, 100A ($t_p=8/20\mu s$)
- Protection for V_{BUS} operating up to 12V
- Benchmark setting protection
- High current handling capability for fast charging applications

For USB Data Pin (D+, D-, ID)

- ESD, IEC 61000-4-2, $\pm 12kV$ contact, $\pm 15kV$ air
- EFT, IEC 61000-4-4, 40A ($t_p=5/50ns$)
- Lightning, IEC 61000-4-5 2nd edition, 4A ($t_p=8/20\mu s$)
- 0.5pF capacitance
- Low clamping voltage and dynamic resistance (0.3 Ω)

Applications

- USB 2.0
- USB OTG
- μ USB
- Protection for the V_{BUS} circuit on USB2.0 Fast Charging

Additional Information



Datasheet



Resources



Samples

Absolute Maximum Ratings

Symbol	Parameter	Value	Units
I_{PP} (Pin 1)	Peak Current ($t_p=8/20\mu s$)	100	A
I_{PP} (Pin 2-4)	Peak Current ($t_p=8/20\mu s$)	4	A
T_{OP}	Operating Temperature	-40 to 125	°C
T_{STOR}	Storage Temperature	-55 to 150	°C

CAUTION: Stresses above those listed in "Absolute Maximum Ratings" may cause permanent damage to the device. This is a stress only rating and operation of the device at these or any other conditions above those indicated in the operational sections of this specification is not implied.

Electrical Characteristics ($T_{OP}=25^\circ C$)

Parameter	Symbol	Test Conditions	Min	Typ	Max	Units
USB V_{BUS} (Pin 1)						
Reverse Standoff Voltage	V_{RWM}	Pin 1 to GND			12	V
Reverse Breakdown Voltage	V_{BR}	$I_T=1mA$, Pin 1 to GND	13.0	13.5	16.5	V
Reverse Leakage Current	I_{LEAK}	$V_R=12V$, Pin 1 to GND			0.1	μA
Forward Voltage	V_F	$I_F=10mA$, GND to Pin 1	0.6	0.7	1.0	V
Clamp Voltage ¹	V_C	$I_{PP}=30A$, $t_p=8/20\mu s$, Fwd		16.5	18	V
		$I_{PP}=100A$, $t_p=8/20\mu s$, Fwd		19.5	25	V
ESD Withstand Voltage ¹	V_{ESD}	IEC 61000-4-2 (Contact)	± 30			kV
		IEC 61000-4-2 (Air)	± 30			kV
Diode Capacitance ¹	C_D	Reverse Bias=0V, $f=1MHz$		1300	2500	pF
USB D+, D-, ID (Pin 2, 3, 4)						
Reverse Standoff Voltage	V_{RWM}	Pin 2, 3 and 4 to GND			4	V
Reverse Breakdown Voltage	V_{BR}	$I_T=2\mu A$, Pin 2, 3 and 4 to GND	4.5	6.0	7.5	V
Reverse Leakage Current	I_{LEAK}	$V_R=2V$, Pin 2, 3 and 4 to GND			0.02	μA
		$V_R=4V$, Pin 2, 3 and 4 to GND			0.1	μA
Clamp Voltage ¹	V_C	$I_{PP}=1A$, $t_p=8/20\mu s$, Fwd		6.6	8.0	V
		$I_{PP}=2A$, $t_p=8/20\mu s$, Fwd		7.0	8.5	V
Dynamic Resistance	R_{DYN}	TLP, $t_p=100ns$, Pin 2, 3 and 4 to GND ²		0.3		Ω
ESD Withstand Voltage ¹	V_{ESD}	IEC 61000-4-2 (Contact)	± 12			kV
		IEC 61000-4-2 (Air)	± 15			kV
Diode Capacitance ¹	C_{VO-GND}	Reverse Bias=0V, $f=1MHz$		0.5	0.6	pF

Note: 1 Parameter is guaranteed by design and/or device characterization.

2 Transmission Line Pulse (TLP) Test Setting: $t_r=100ns$, $t_f=0.2ns$ I_{TL} and V_{TL} , averaging window: star $t_r=70ns$ to $t_f=90ns$

Capacitance vs. Reverse Bias (Pin 1 to GND)

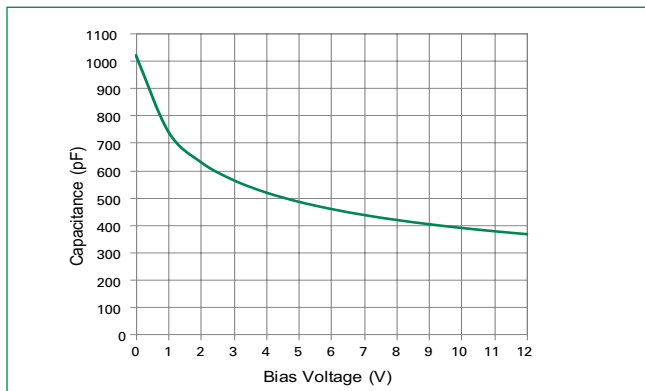

Capacitance vs. Reverse Bias (Pin 2, 3, 4 to GND)

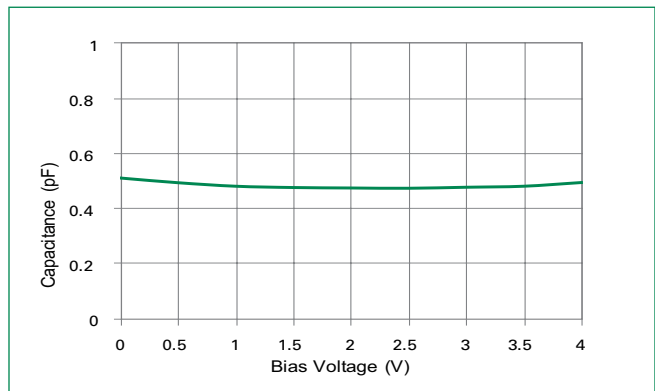

Non-Repetitive Peak Pulse Power vs. Pulse Duration (Pin1 to GND)

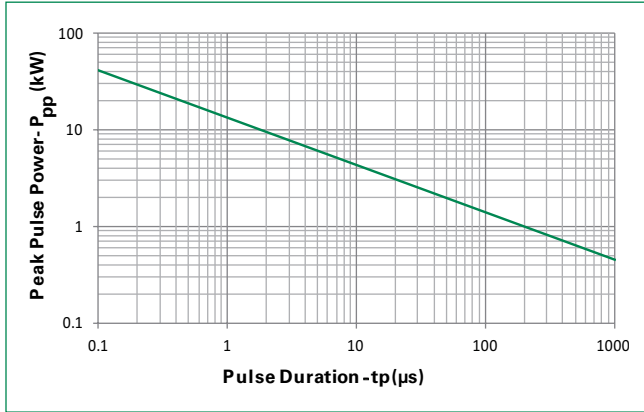

Non-Repetitive Peak Pulse Power vs. Pulse Duration (Pin2, 3, 4 to GND)

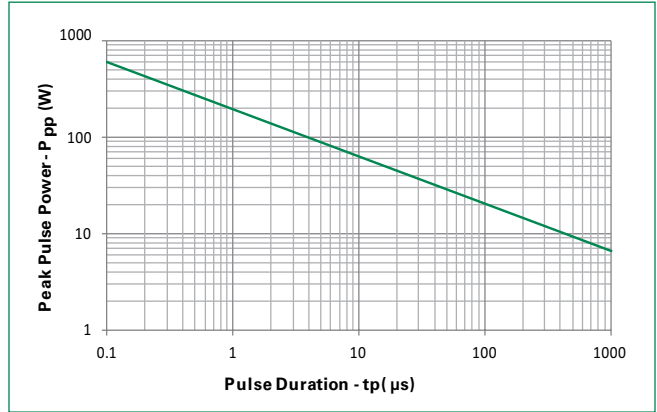

Clamping Voltage vs. Peak Pulse Current (Pin1 to GND)

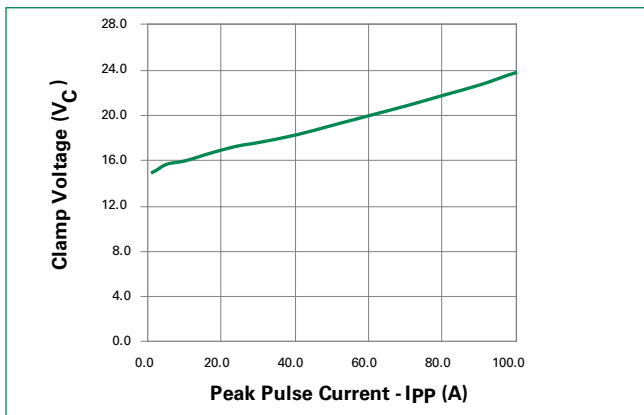

Clamping Voltage vs. Peak Pulse Current (Pin2, 3, 4 to GND)

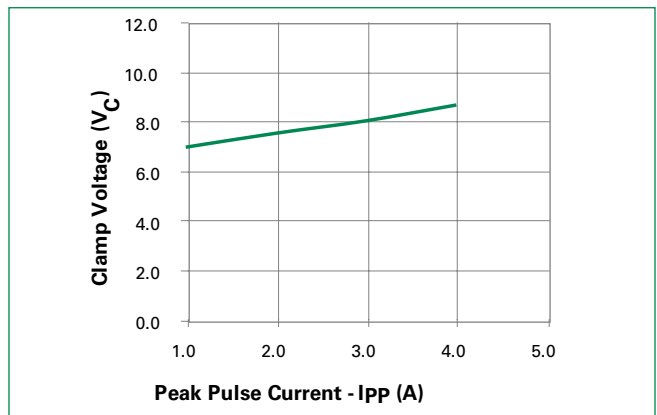

Positive Transmission Line Pulsing (TLP) Plot (Pin 2, 3, 4 to GND)

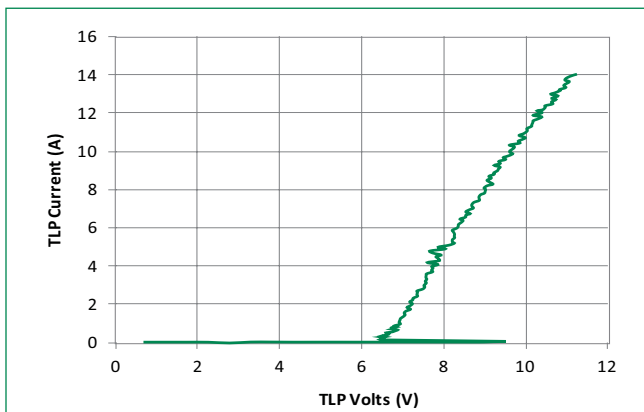

Negative Transmission Line Pulsing (TLP) Plot (Pin 2, 3, 4 to GND)

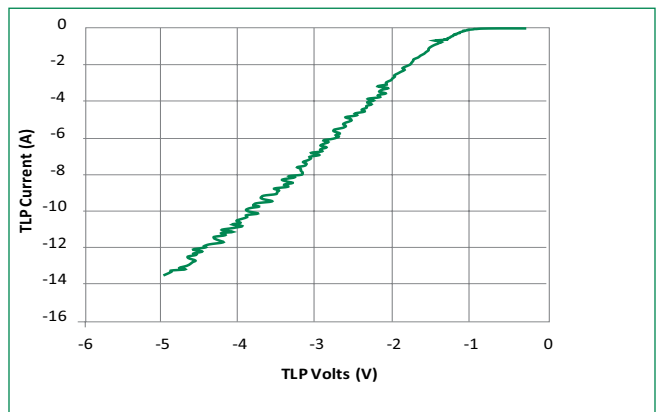

Soldering Parameters

Reflow Condition		Pb – Free assembly
Pre Heat	- Temperature Min ($T_{s(min)}$)	150°C
	- Temperature Max ($T_{s(max)}$)	200°C
	- Time (min to max) (t_s)	60 – 180 secs
Average ramp up rate (Liquidus) Temp (T_L) to peak		3°C/second max
$T_{s(max)}$ to T_L - Ramp-up Rate		3°C/second max
Reflow	- Temperature (T_L) (Liquidus)	217°C
	- Temperature (t_L)	60 – 150 seconds
Peak Temperature (T_p)		260 ^{+0/-5} °C
Time within 5°C of actual peak Temperature (t_p)		20 – 40 seconds
Ramp-down Rate		6°C/second max
Time 25°C to peak Temperature (T_p)		8 minutes Max.
Do not exceed		260°C

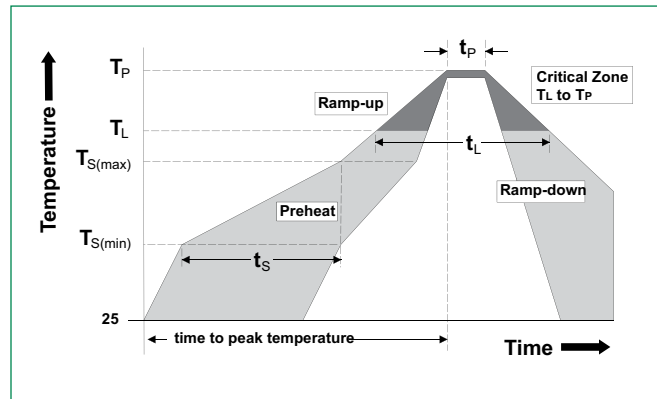

Part Numbering System

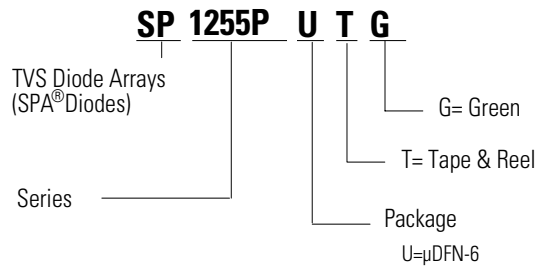

Product Characteristics

Lead Plating	Pre-Plated Frame
Lead Material	Copper Alloy
Lead Coplanarity	0.0004 inches (0.102mm)
Substrate material	Silicon
Body Material	Molded Epoxy
Flammability	UL 94 V-0

Notes :

1. All dimensions are in millimeters
2. Dimensions include solder plating.
3. Dimensions are exclusive of mold flash & metal burr.
4. Blo is facing up for mold and facing down for trim/form, i.e. reverse trim/form.
5. Package surface matte finish VDI 11-13.

Part Marking System

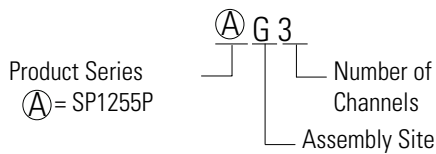

Ordering Information

Part Number	Package	Marking	Min. Order Qty.	Packaging Option	P0/P1	Packaging Specification
SP1255PUTG	μDFN-6	Ⓐ3	3000	Tape & Reel – 8mm tape/7" reel	2mm/4mm	EIA RS-481

Package Dimensions — μ DFN-6 (1.8x2.0x0.55mm)

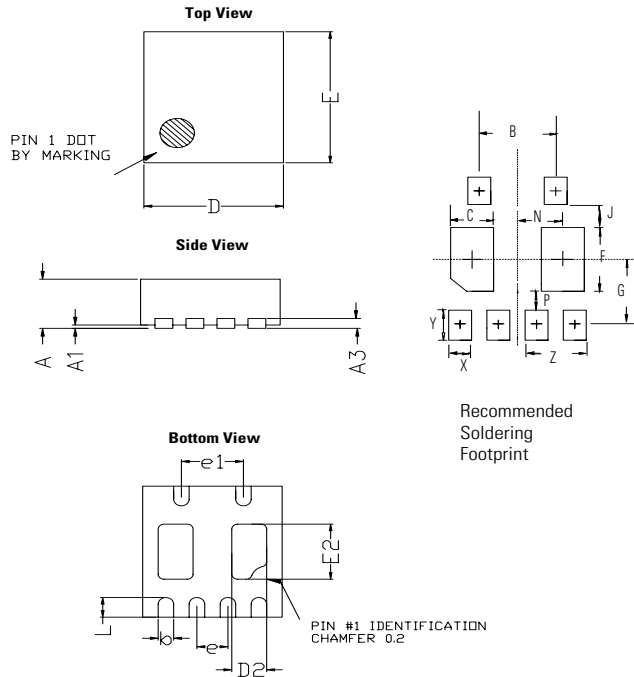

μ DFN6 (1.8x2.0x0.55mm)						
JEDEC MO-229						
Symbol	Millimeters			Inches		
	Min	Nom	Max	Min	Nom	Max
A	0.50	0.55	0.60	0.020	0.022	0.024
A1	0.00	-	0.05	0.000	-	0.002
A3	0.15 Ref			0.006 Ref		
D	1.75	1.80	1.85	0.069	0.071	0.073
E	1.95	2.00	2.05	0.077	0.079	0.081
b	0.15	0.20	0.25	0.006	0.008	0.010
L	0.20	0.30	0.40	0.008	0.012	0.016
D2	0.35	0.45	0.55	0.014	0.018	0.022
E2	0.74	0.84	0.94	0.029	0.033	0.037
e	0.40 BSC			0.016 BSC		
e1	0.80 BSC			0.031 BSC		
B	0.80 BSC			0.031 BSC		
C	0.35	0.45	0.55	0.014	0.018	0.022
F	0.81	0.84	0.87	0.032	0.033	0.034
G	0.82	0.85	0.88	0.032	0.033	0.034
J	0.24	0.25	0.26	0.010	0.010	0.010
N	0.47	0.48	0.49	0.018	0.019	0.020
P	0.24	0.25	0.26	0.010	0.010	0.010
X	0.23	0.24	0.25	0.009	0.009	0.009
Y	0.35	0.36	0.37	0.014	0.014	0.014
Z	0.62	0.64	0.66	0.024	0.025	0.026

Notes:

1. Dimension and tolerancing conform to ASME Y14.5M-1994.
2. Controlling dimensions: Millimeter. Converted Inch dimensions are not necessarily exact.

Embossed Carrier Tape & Reel Specification — μ DFN-6

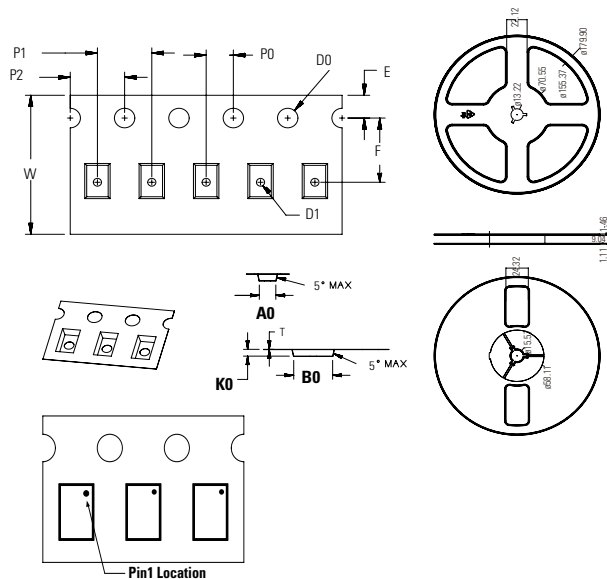

Symbol	Millimeters
A0	1.95 +/- 0.05
B0	2.30 +/- 0.05
D0	1.50 + 0.10
D1	Ø 0.60 + 0.05
E	1.75 +/- 0.10
F	3.50 +/- 0.05
K0	0.75 +/- 0.05
P0	2.00 +/- 0.05
P1	4.00 +/- 0.10
P2	4.00 +/- 0.10
T	0.25 +/- 0.02
W	8.00 + 0.30 /- 0.10