

# SC1333-01ETG Series

## General Purpose ESD Protection

HF RoHS Pb



### Pinout

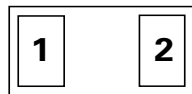

### Functional Block Diagram

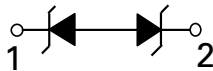

### Description

The SC1333-01ETG back-to-back diodes are fabricated in a proprietary silicon avalanche technology. These diodes provide a high ESD (electrostatic discharge) protection level for electronic equipment. The SC1333-01ETG TVS can safely absorb repetitive ESD strikes at the maximum level specified in the IEC 61000-4-2 international standard (Level 4,  $\pm 8\text{kV}$  contact discharge) without performance degradation. The back-to-back configuration provides symmetrical ESD protection for data lines. Additionally, the SC1333-01ETG offers up to 5A 8/20 $\mu\text{s}$  surge rating with low clamping voltages.

### Features & Benefits

- ESD, IEC 61000-4-2,  $\pm 30\text{kV}$  contact,  $\pm 30\text{kV}$  air
- EFT, IEC 61000-4-4, 40A (5/50ns)
- Lightning, IEC 61000-4-5, 2nd Edition, 5A (8/20 $\mu\text{s}$ )
- Low capacitance of 8pF (TYP @ VR=0V)
- Low leakage current of 1nA (TYP) at 3.3V
- Space Efficient 0402
- Halogen free, Lead free and RoHS compliant
- Moisture Sensitivity Level (MSL -1)

### Applications

- Mobile Phones
- Smart Phones
- Portable Medical
- MP3/PMP
- Portable Navigation Components
- Tablets
- Small Size Panel
- Point of Sale Terminals

Life Support Note:

#### Not Intended for Use in Life Support or Life Saving Applications

The products shown herein are not designed for use in life sustaining or life saving applications unless otherwise expressly indicated.

# SC1333-01ETG Series

## General Purpose ESD Protection

### Absolute Maximum Ratings

Symbol	Parameter	Value	Units
$I_{PP}$	Peak Current ( $t_p=8/20\mu s$ )	5	A
$T_{OP}$	Operating Temperature	-40 to 125	°C
$T_{STOR}$	Storage Temperature	-55 to 150	°C

**Caution:** Stresses above those listed in "Absolute Maximum Ratings" may cause permanent damage to the component. This is a stress only rating and operation of the component at these or any other conditions above those indicated in the operational sections of this specification is not implied.

### Electrical Characteristics ( $T_{OP}=25^\circ C$ )

Parameter	Symbol	Test Conditions	Min	Typ	Max	Units
Reverse Standoff Voltage	$V_{RWM}$	$I_R=1\mu A$			3.3	V
Breakdown Voltage	$V_{BR}$	$I_R=1mA$	3.5	4.5		V
Reverse Leakage Current	$I_{LEAK}$	$V_R=3.3V$		1	50	nA
Clamp Voltage <sup>1</sup>	$V_C$	$I_{PP}=1A, t_p=8/20\mu s, I/O$ to I/O		5	7	V
		$I_{PP}=5A, t_p=8/20\mu s, I/O$ to I/O		7.5	9	V
Dynamic Resistance <sup>2</sup>	$R_{DYN}$	TLP, $t_p=100ns, I/O$ to I/O		0.3		$\Omega$
ESD Withstand Voltage <sup>1</sup>	$V_{ESD}$	IEC 61000-4-2 (Contact Discharge)	$\pm 30$			kV
		IEC 61000-4-2 (Air Discharge)	$\pm 30$			kV
Diode Capacitance <sup>1</sup>	$C_{I/O-I/O}$	Reverse Bias=0V, f=1MHz		8	10	pF

**Note:**

- Parameter is guaranteed by design and/or component characterization.
- Transmission Line Pulse (TLP) with 100ns width, 2ns rise time, and average window  $t1=70ns$  to  $t2=90ns$

### 8/20 $\mu s$ Pulse Waveform

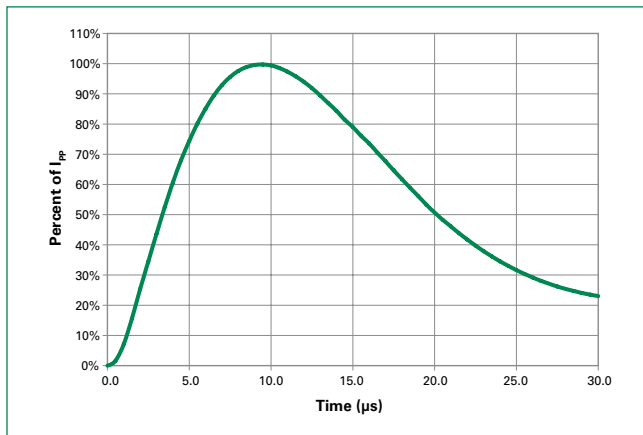

# SC1333-01ETG Series

## General Purpose ESD Protection

**Capacitance vs Reverse Bias**

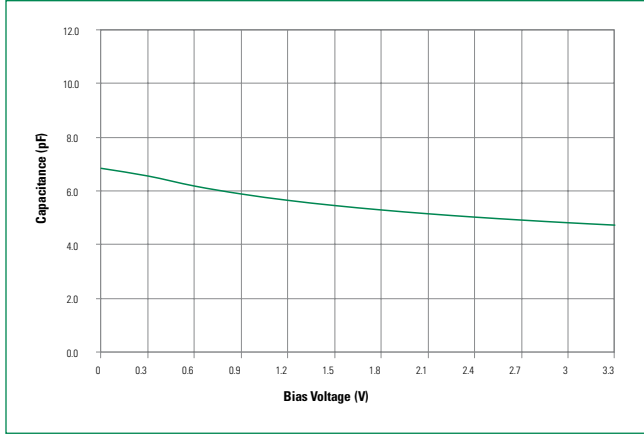

**Clamping Voltage vs I<sub>pp</sub>**

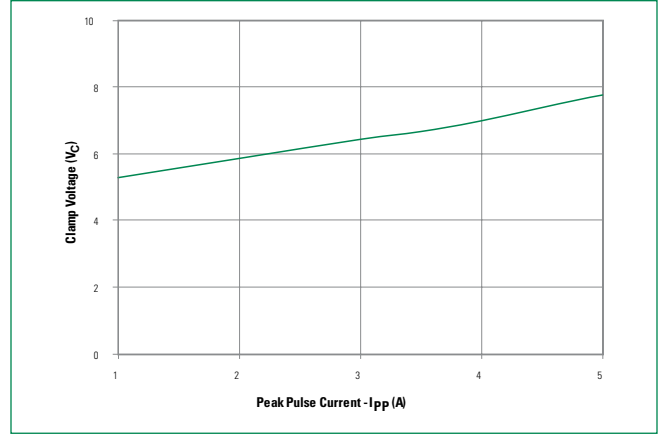

**Positive TLP**

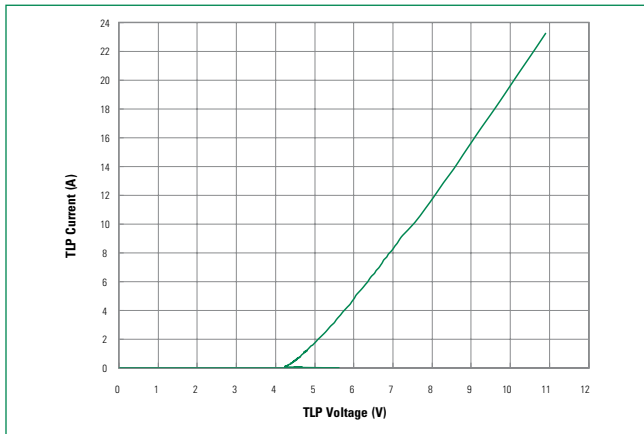

**Negative TLP**

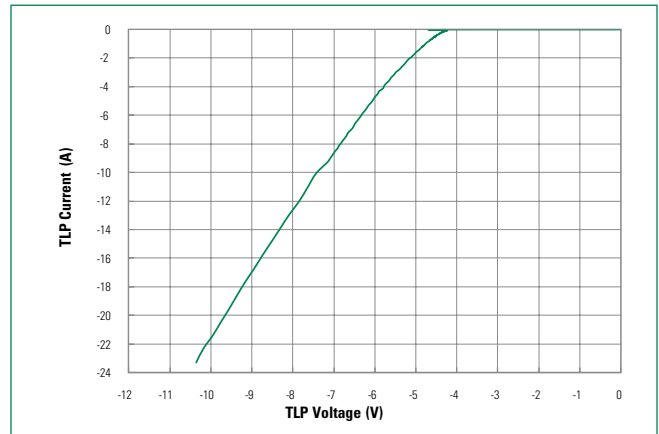

**IEC Contact Discharge at +8 kV**

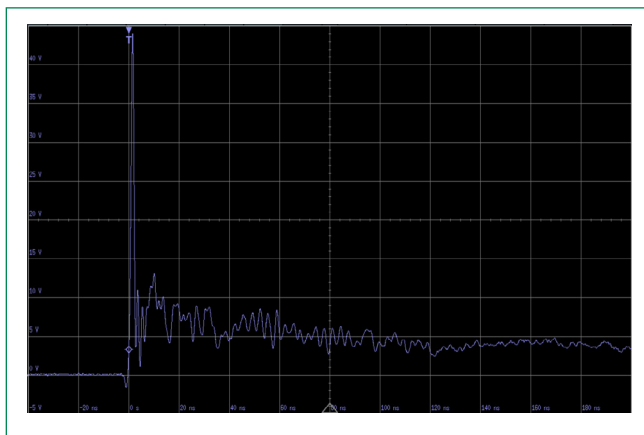

**IEC Contact Discharge at -8 kV**

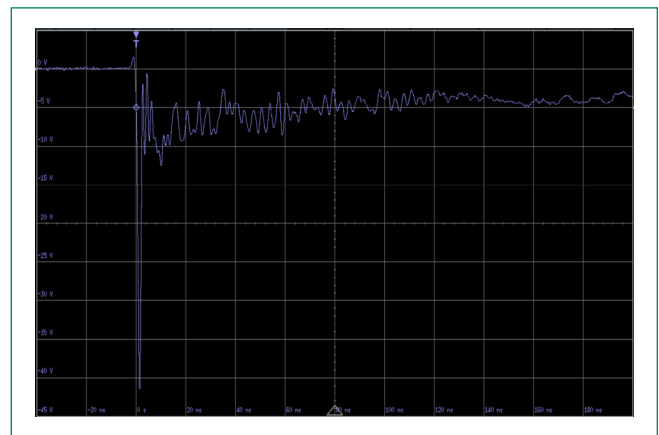

# SC1333-01ETG Series

## General Purpose ESD Protection

### Soldering Parameters

<b>Reflow Condition</b>		Pb – Free assembly
<b>Pre Heat</b>	- Temperature Min ( $T_{s(min)}$ )	150°C
	- Temperature Max ( $T_{s(max)}$ )	200°C
	- Time (min to max) ( $t_s$ )	60 – 120 secs
<b>Average ramp up rate (Liquidus) Temp (<math>T_L</math>) to peak</b>		3°C/second max
<b><math>T_{s(max)}</math> to <math>T_L</math> - Ramp-up Rate</b>		3°C/second max
<b>Reflow</b>	- Temperature ( $T_L$ ) (Liquidus)	217°C
	- Temperature ( $t_L$ )	60 – 150 seconds
<b>Peak Temperature (<math>T_p</math>)</b>		260 <sup>+0/-5</sup> °C
<b>Time within 5°C of actual peak Temperature (<math>t_p</math>)</b>		30 seconds
<b>Ramp-down Rate</b>		6°C/second max
<b>Time 25°C to peak Temperature (<math>T_p</math>)</b>		8 minutes Max.
<b>Do not exceed</b>		260°C

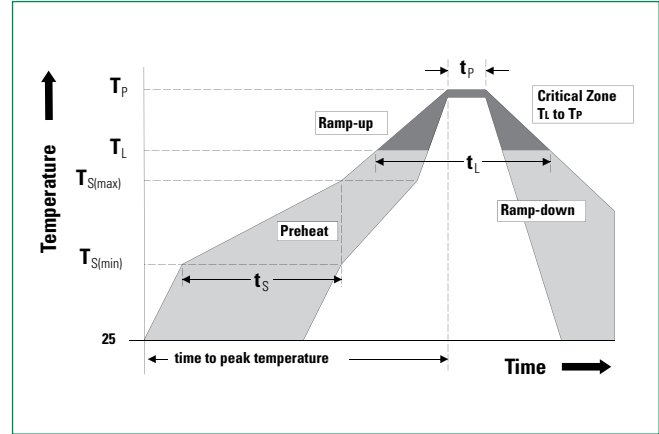

### Product Characteristics

<b>Lead Plating</b>	Pre-Plated Frame Matte Tin
<b>Lead material</b>	Copper Alloy
<b>Substrate Material</b>	Silicon
<b>Body Material</b>	Molded Compound
<b>Flammability</b>	UL Recognized compound meeting flammability rating V-0

### Ordering Information

Part Number	Package	Min. Order Qty.
SC1333-01ETG	SOD882	10000

### Part Marking System

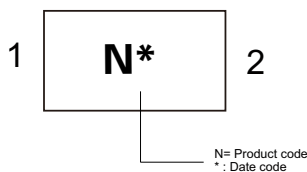

### Part Numbering System

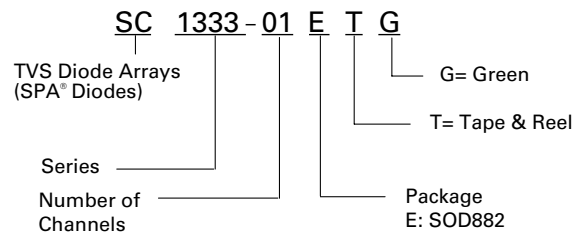

# SC1333-01ETG Series

## General Purpose ESD Protection

### Package Dimensions – SOD882

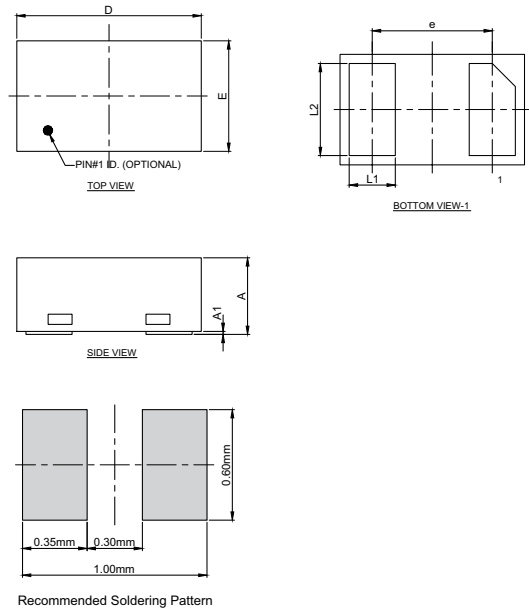

Symbol	SOD882					
	Millimeters			Inches		
	Min	Typ	Max	Min	Typ	Max
<b>A</b>	0.40	0.50	0.55	0.016	0.020	0.022
<b>A1</b>	0.00	0.02	0.05	0.000	0.001	0.002
<b>L1</b>	0.20	0.25	0.30	0.008	0.010	0.012
<b>L2</b>	0.45	0.50	0.55	0.018	0.020	0.022
<b>D</b>	0.95	1.00	1.05	0.037	0.039	0.041
<b>E</b>	0.55	0.60	0.65	0.022	0.024	0.026
<b>e</b>	0.65 BSC			0.026 BSC		

### Embossed Carrier Tape & Reel Specification – SOD882

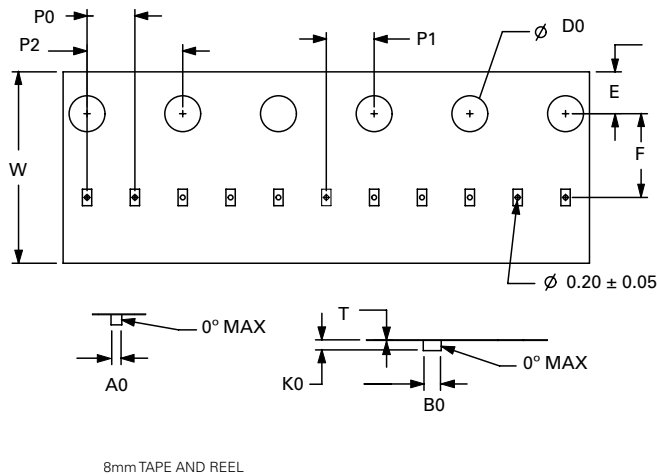

Symbol	Millimeters		Inches	
	Min	Max	Min	Max
<b>A0</b>	0.66	0.78	0.026	0.031
<b>B0</b>	1.07	1.24	0.042	0.049
<b>D0</b>	1.50	1.60	0.059	0.063
<b>E</b>	1.65	1.85	0.065	0.073
<b>F</b>	3.40	3.60	0.134	0.142
<b>K0</b>	0.47	0.66	0.019	0.026
<b>P0</b>	1.90	2.10	0.075	0.083
<b>P1</b>	1.90	2.10	0.075	0.083
<b>P2</b>	3.90	4.10	0.154	0.161
<b>T</b>	0.18	0.25	0.007	0.010
<b>W</b>	7.80	8.20	0.307	0.323

**Product Disclaimer:** Littelfuse products are not designed for, and shall not be used for, any purpose (including, without limitation, automotive, military, aerospace, medical, life-saving, life-sustaining or nuclear facility applications, devices intended for surgical implant into the body, or any other application in which the failure or lack of desired operation of the product may result in personal injury, death, or property damage) other than those expressly set forth in applicable Littelfuse product documentation. Warranties granted by Littelfuse shall be deemed void for products used for any purpose not expressly set forth in applicable Littelfuse documentation. Littelfuse shall not be liable for any claims or damages arising out of products used in applications not expressly intended by Littelfuse as set forth in applicable Littelfuse documentation. The sale and use of Littelfuse products is subject to Littelfuse Terms and Conditions of Sale, unless otherwise agreed by Littelfuse. "Littelfuse" includes Littelfuse, Inc., and all of its affiliate entities. <http://www.littelfuse.com/disclaimer-electronics>