

High Current & Voltage Cartridge Fuses

Lead-free > 10x32mm Fuse > 607 Series



Description

The 607 series fuses are specifically designed and tested to cater to the circuit protection needs of compact applications, which is 500Vdc/Vac rated with remarkable interrupting rating.

Features

- RoHS compliant and Lead-free
- High Interrupt Rating
- Rated voltage 500 Vdc/Vac

Benefits

- Small size
- High current
- High voltage
- High breaking capacity

Applications

- Data Center Power Supplies
- Uninterruptible Power Supply (UPS)
- Power conversion equipment like inverters and rectifiers

Agency Approvals

Agency	Agency File Number	Ampere Range
	E71611	40 A to 63 A
	J 50514752	40 A to 63 A

Electrical Characteristics

% of Ampere Rating	Ampere Rating	Opening Time at 25°C
100%	40 A to 63 A	4hrs, Min.
200%	40 A to 63 A	120 seconds, Max.

Additional Information



Resources



Accessories



Samples

Electrical Specifications

Ampere Rating (A)	Amp Code	Max Voltage Rating (V)	Interrupting Rating (AC/DC)	Nominal Code Resistance (Ohm)	Nominal Melting I ² t (A ² sec)	Agency Approvals	
40	040.	500VDC 500VAC	10KA@500VDC 10KA@500VAC	0.00187	2570	x	x
50	050.			0.00145	4230	x	x
63	063.	500VDC 500VAC 300VAC	10KA@500VDC 5KA@500VAC 10KA@300VAC	0.00102	7060	x	x

Note

Unless otherwise stated, all specifications are referenced at room ambient temperature.

High Current & Voltage Cartridge Fuses

Lead-free > 10x32mm Fuse > 607 Series

Temperature Re-rating Curve

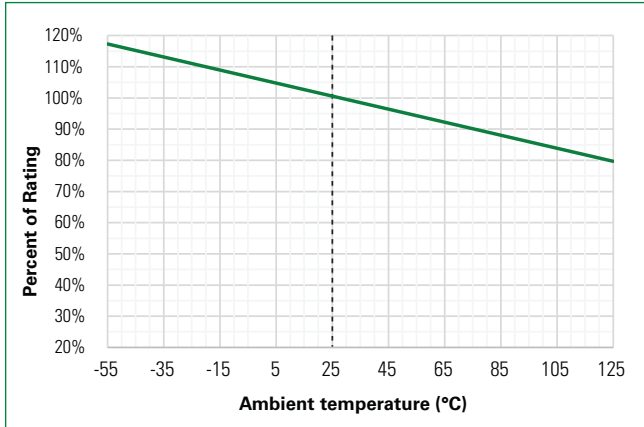

Note:
Derating depicted in this curve is in addition to the standard derating of 25% for continuous operation.

Average Time Current Curves

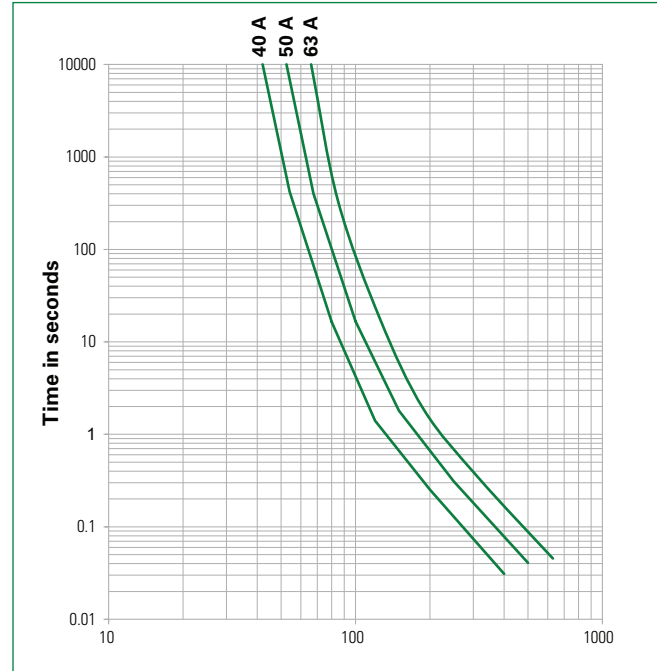

Product Characteristics

Materials	Body: Glass fiber Cap: Ni plated copper alloy Terminal: Tin plated copper alloy
Mechanical Shock	MIL-STD-202, Method 213, Test Condition I (100 G's peak for 6 milliseconds)
Solderability	Reference MIL-STD-202 method 208
Product Marking	Cap 1: Brand logo, current and voltage ratings Cap 2: Agency approval marks
Resistance to Solder Heat	MIL-Std 202 Method 210 Test Condition B (10sec at 260 °C)
Operating Temperature	-55 °C to +125 °C
Thermal Shock	MIL-STD-202G, Method 107G, Test condition B
Vibration	MIL-STD-202G, Method 201A
Moisture Resistance	MIL-STD-202G, Method 103B, Test condition A
Salt Spray	MIL-STD-202G, Method 101E, Test condition B

Soldering Parameters—Wave Soldering

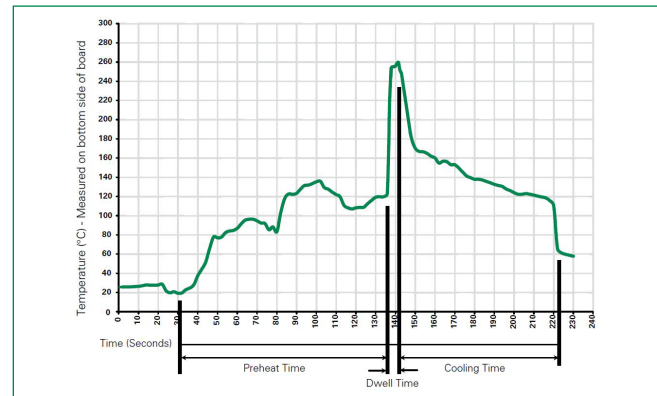

Wave Parameter	Lead-Free Recommendation
Preheat: (Depends on Flex Activation Temperature)	(Typical Industry Recommendation)
Temperature Minimum	100 °C
Temperature Maximum	150 °C
Preheat Time	60–180 seconds
Solder Pot Temperature	260 °C Maximum
Solder Dwell Time	2–5 seconds

Recommended Hand-Solder Parameters:

Solder Iron Temperature: 350 °C +/- 5 °C
Heating Time: 5 seconds max.

Note: These devices are not recommended for IR or Convection Reflow process.

High Current & Voltage Cartridge Fuses

Lead-free > 10x32mm Fuse > 607 Series

Dimensions

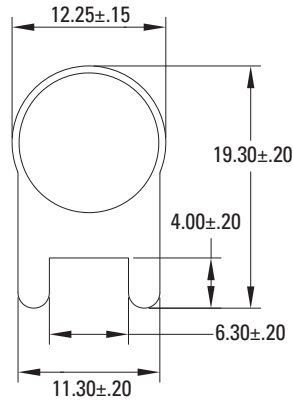
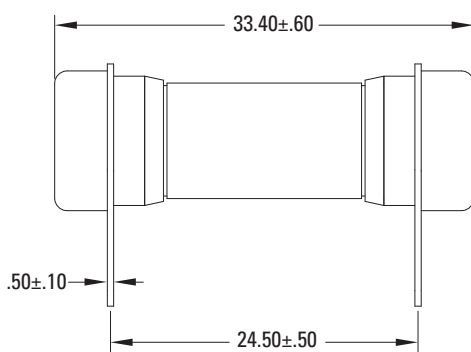

All dimensions in mm

Recommended PCB Layout

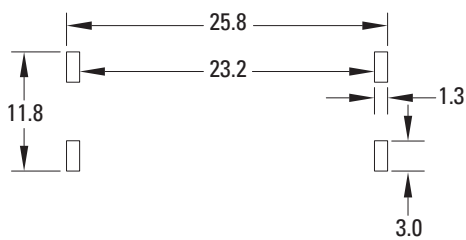

Part Numbering System

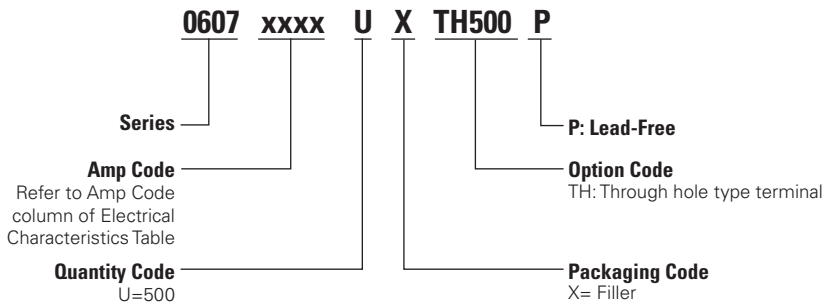

Packaging

Packaging Option	Packaging Specification	Quantity	Quantity & Packaging Code	Reel Size
607 Series				
Tray	NA	500	NA	NA

Disclaimer Notice - Information furnished is believed to be accurate and reliable. However, users should independently evaluate the suitability of and test each product selected for their own applications. Littelfuse products are not designed for, and may not be used in, all applications. Read complete Disclaimer Notice at <http://www.littelfuse.com/disclaimer-electronics>.