

CoolMOS™ 1) Power MOSFET

ISOPLUS™ - electrically isolated surface to heatsink

Surface Mount Power Device

$I_{D25} = 50 \text{ A}$
 $V_{DSS} = 600 \text{ V}$
 $R_{DS(on) \text{ max}} = 45 \text{ m}\Omega$

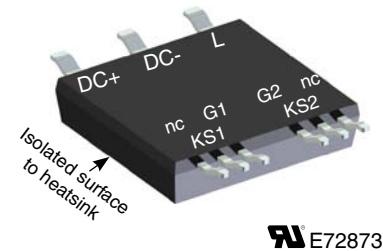
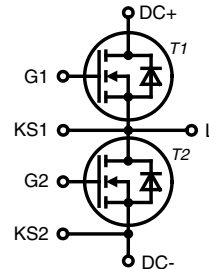

MOSFETs T1, T2

Symbol	Conditions	Maximum Ratings	
V_{DSS}	$T_{VJ} = 25^\circ\text{C to } 150^\circ\text{C}$	600	V
V_{GS}		± 20	V
I_{D25}	$T_C = 25^\circ\text{C}$	50	A
I_{D80}	$T_C = 80^\circ\text{C}$	38	A
E_{AS} E_{AR}	single pulse repetitive } $I_D = 11 \text{ A}; T_C = 25^\circ\text{C}$	1950	mJ
		3	mJ
dV/dt	MOSFET dV/dt ruggedness $V_{DS} = 0 \dots 480 \text{ V}$	50	V/ns

Features

- **Fast CoolMOS™ 1)** power MOSFET 4th generation
 - high blocking capability
 - lowest resistance
 - avalanche rated for unclamped inductive switching (UIS)
 - low thermal resistance due to reduced chip thickness
- **Package**
 - isolated surface to heatsink
 - low coupling capacity between pins and heatsink
 - PCB space saving
 - enlarged creepage towards heatsink
 - application friendly pinout
 - low inductive current path
 - high reliability

Applications

- Switch mode power supplies (SMPS)
- Soft switching topologie
- Resonant converter

¹⁾ CoolMOS™ is a trademark of Infineon Technologies AG.

Symbol	Conditions	Characteristic Values				
		min.	typ.	max.		
$R_{DS(on)}$	$I_D = 44 \text{ A}; V_{GS} = 10 \text{ V}$		40	45	m Ω	
$V_{GS(th)}$	$I_D = 3 \text{ mA}; V_{DS} = V_{GS}$	2.5	3	3.5	V	
I_{DSS}	$V_{DS} = V_{DSS}; V_{GS} = 0 \text{ V};$ $T_{VJ} = 25^\circ\text{C}$ $T_{VJ} = 125^\circ\text{C}$		50	10	μA μA	
I_{GSS}	$V_{DS} = 0 \text{ V}; V_{GS} = \pm 20 \text{ V}$			100	nA	
C_{iss} C_{oss}	} $V_{GS} = 0 \text{ V}; V_{DS} = 100 \text{ V}; f = 1 \text{ MHz}$		6800		pF	
				320		pF
Q_g Q_{gs} Q_{gd}	} $V_{DS} = 400 \text{ V}; I_D = 44 \text{ A}$ $V_{GS} = 10 \text{ V}; R_G = 3.3 \Omega$		150	190	nC	
				35		nC
				50		nC
$t_{d(on)}$ t_r $t_{d(off)}$ t_f E_{on} E_{off}	} Resistive switching $T_{VJ} = 125^\circ\text{C}$ $V_{DS} = 380 \text{ V}; I_D = 30 \text{ A}$ $V_{GS} = 10 \text{ V}; R_G = 3.3 \Omega$		22		ns	
				10		ns
				120		ns
				12		ns
				70		μJ
				22		μJ
$t_{d(on)}$ t_r $t_{d(off)}$ t_f E_{on} E_{off} $E_{rec(off)}$	} Inductive switching $T_{VJ} = 25^\circ\text{C}$ $V_{DS} = 380 \text{ V}; I_D = 30 \text{ A}$ $V_{GS} = 10 \text{ V}; R_G = 330 \Omega$		900		ns	
				400		ns
						ns
				520		ns
				18		mJ
				5.2		mJ
				0.18		mJ
R_{thJC} R_{thJH}	with heatsink compound; IXYS test setup			0.4	K/W	
				0.6		K/W

Source-Drain Diodes of T1/T2

Symbol	Conditions	Maximum Ratings		
I_{S25}	$T_C = 25^\circ\text{C}$	50	A	
I_{S80}	$T_C = 80^\circ\text{C}$	38	A	

Symbol	Conditions	Characteristic Values			
($T_{VJ} = 25^\circ\text{C}$, unless otherwise specified)					
		min.	typ.	max.	
V_{SD}	$I_F = 44\text{ A}; V_{GS} = 0\text{ V}$		0.95	1.25	V
t_{rr}	$I_F = 44\text{ A}; -di_F/dt = 100\text{ A}/\mu\text{s}; V_R = 400\text{ V}$		600		ns
Q_{RM}			17		μC
I_{RM}			60		A

Component

Symbol	Conditions	Maximum Ratings		
T_{VJ}		-55...+150	$^\circ\text{C}$	
T_{stg}		-55...+125	$^\circ\text{C}$	
V_{ISOL}	$I_{ISOL} \leq 1\text{ mA}; 50/60\text{ Hz}$	2500	V~	
F_C	mounting force	40 ... 130	N	

Symbol	Conditions	Characteristic Values			
		min.	typ.	max.	
C_p	coupling capacity between shorted pins and backside metal		90		pF
d_S, d_A	pin - pin	1.65			mm
d_S, d_A	pin - backside metal	4			mm
CTI		400			
Weight			8		g

Ordering	Part Name	Marking on Product	Delivering Mode	Base Qty	Ordering Code
Standard	MKE38P600LB-TRR	MKE38P600LB	Tape&Reel	200	510486
	MKE38P600LB	MKE38P600LB	Blister	45	480601

Dimensions in mm
(1 mm = 0.0394")

A (8 : 1)

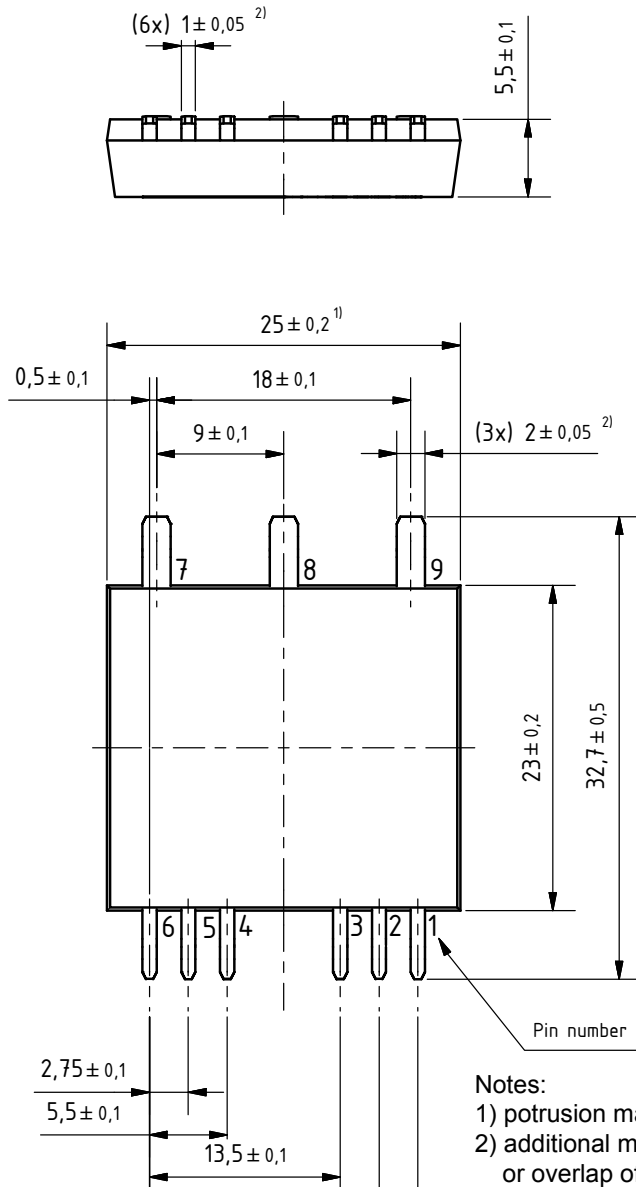

Notes:

- 1) protrusion may add 0.2 mm max. on each side
- 2) additional max. 0.05 mm per side by punching misalignment or overlap of dam bar or bending compression

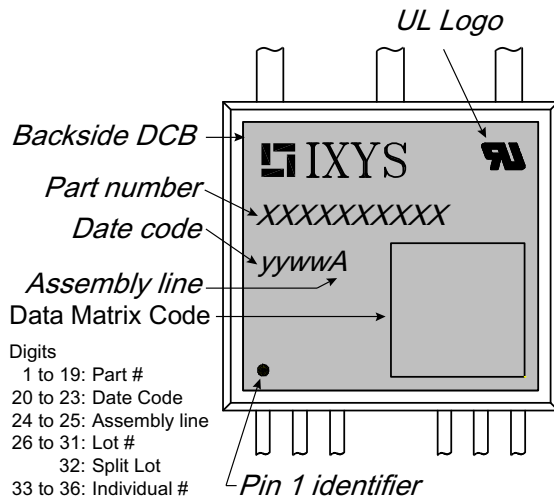

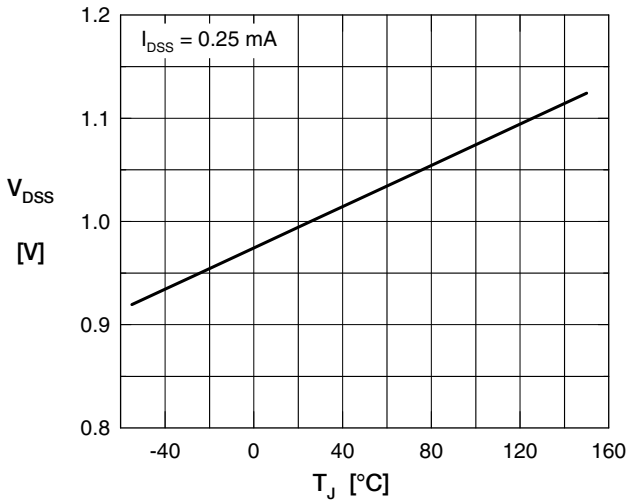

Fig.1 Drain source breakdown voltage versus temperature T_{VJ}

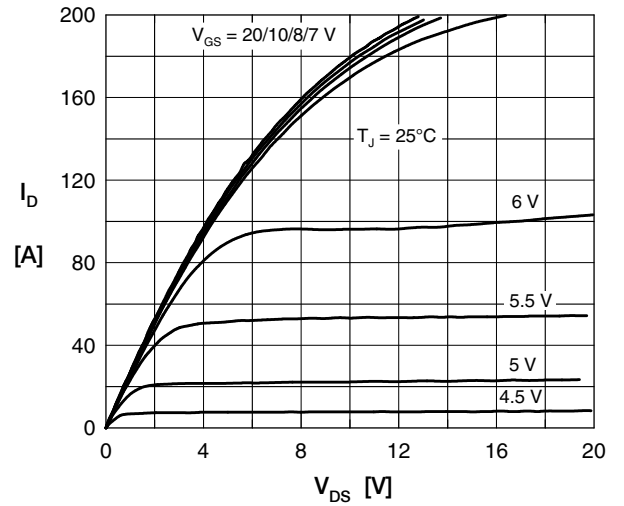

Fig. 2 Typ. output characteristics

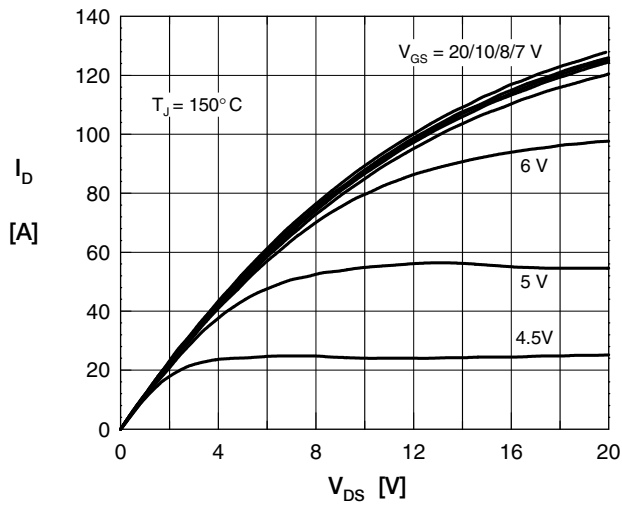

Fig. 3 Typ. output characteristics

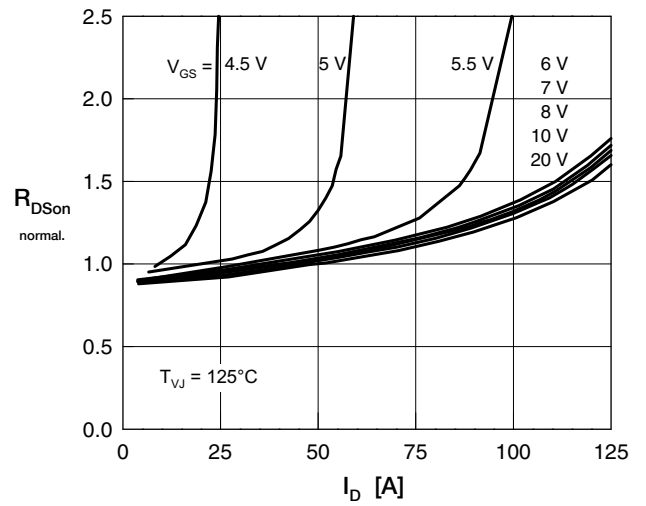

Fig. 4 Drain source on-state resistance $R_{DS(on)}$ versus I_D

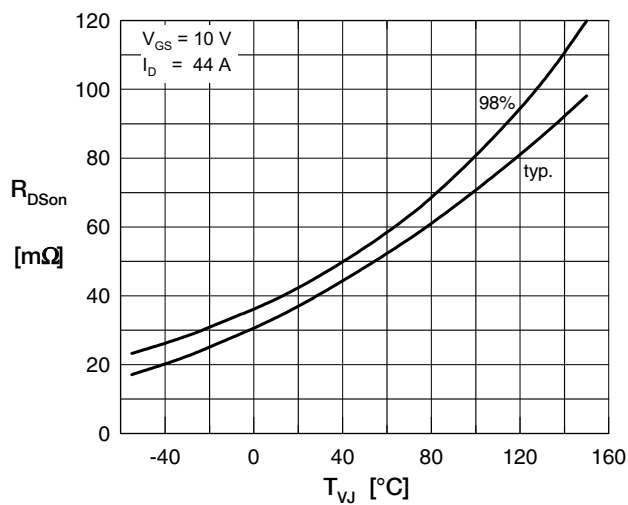

Fig.5 Drain source on-state resistance $R_{DS(on)}$ vs. junction temperature T_{VJ}

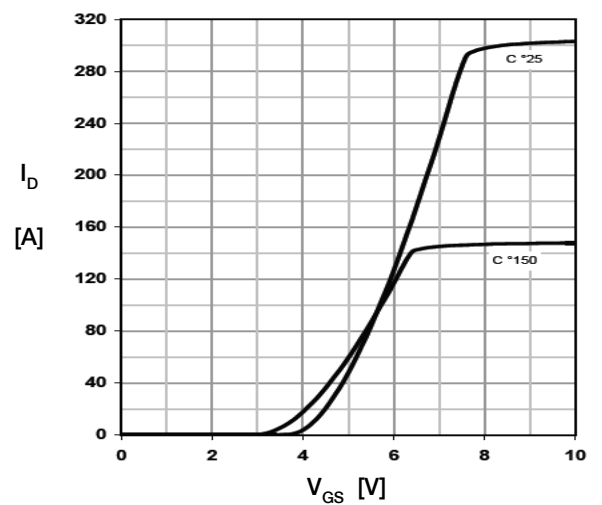

Fig.6 Typ. transfer characteristics

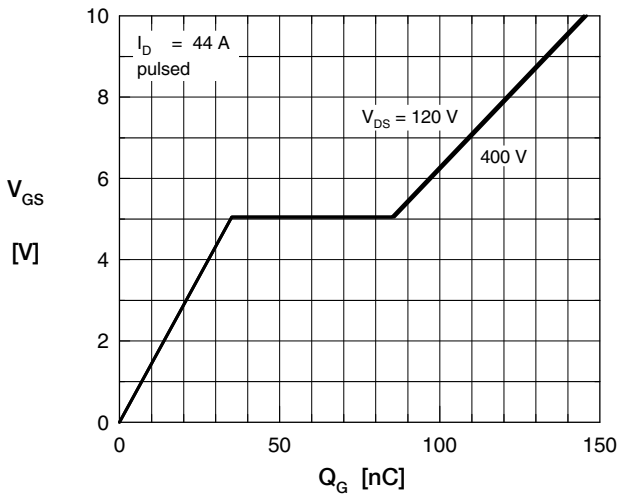

Fig. 7 Typ. turn-on gate charge

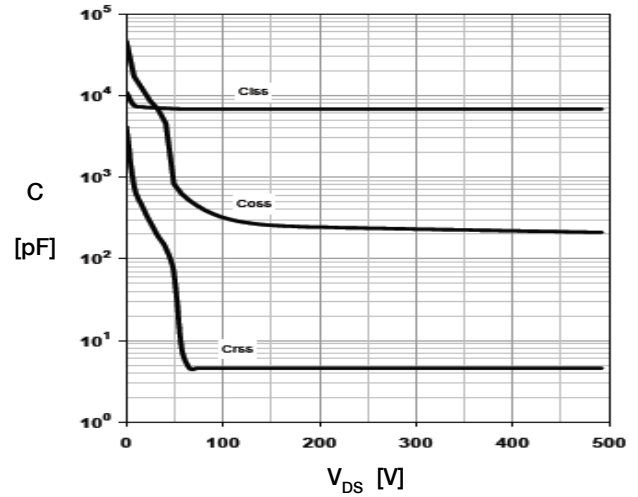

Fig. 8 Typ. capacities, MOSFET only

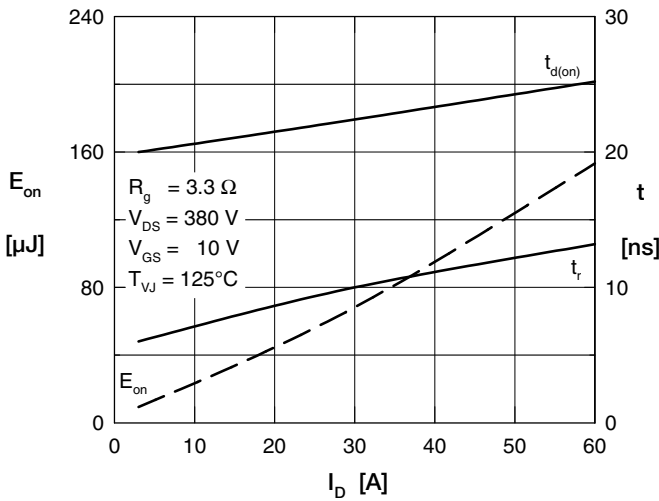

Fig.9 Typ. turn-on energy and switching times versus collector current, resistive switching

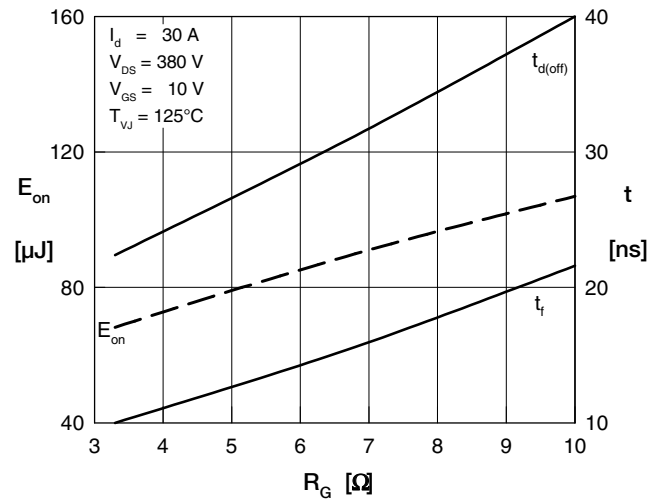

Fig. 10 Typ. turn-on energy and switching times versus gate resistor, resistive switching

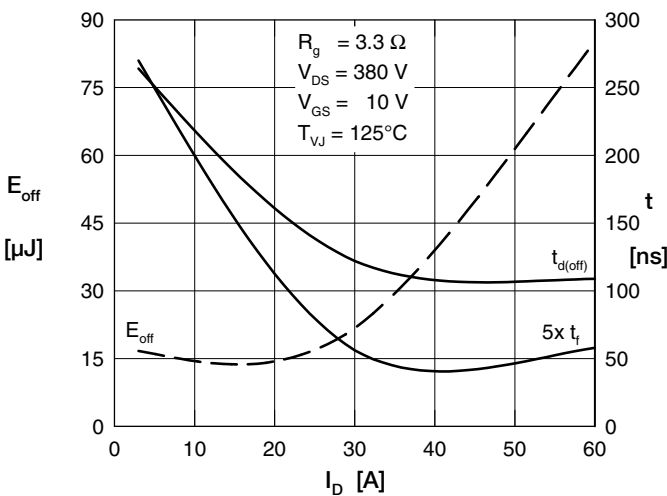

Fig.11 Typ. turn-off energy and switching times vs. collector current, resistive switching

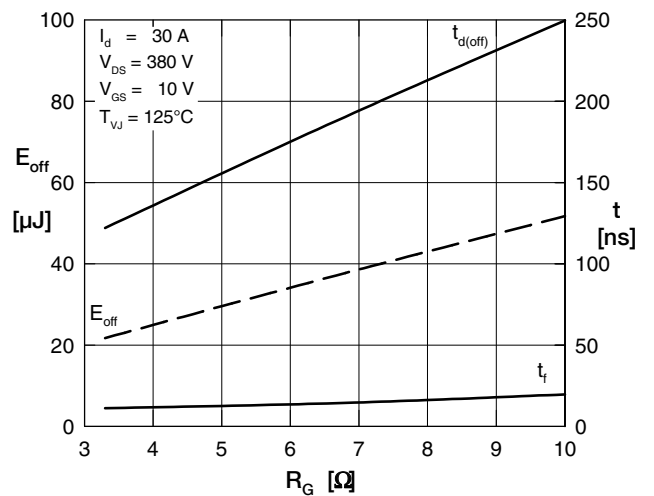

Fig. 12 Typ. turn-off energy and switching times versus gate resistor, resistive switching

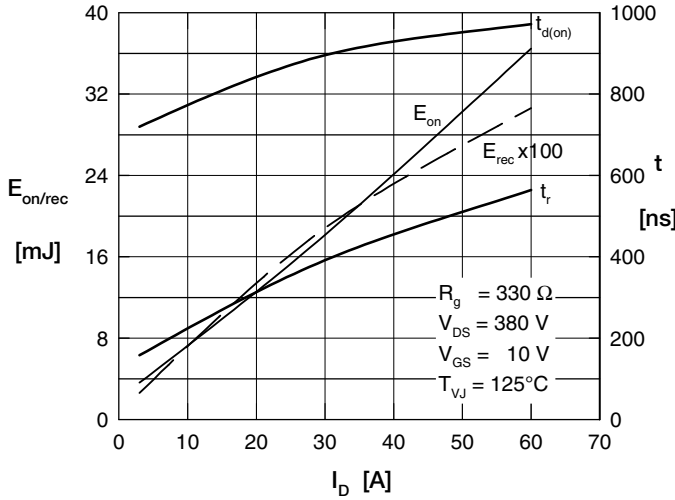

Fig. 13 Typ. turn-on energy & switching times versus collector current, inductive switching (phaseleg)

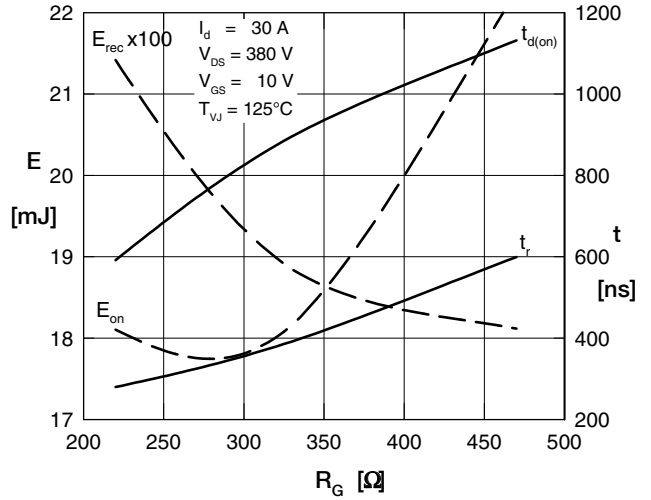

Fig. 14 Typ. turn-on energy & switching times versus gate resistor, inductive switching (phaseleg)

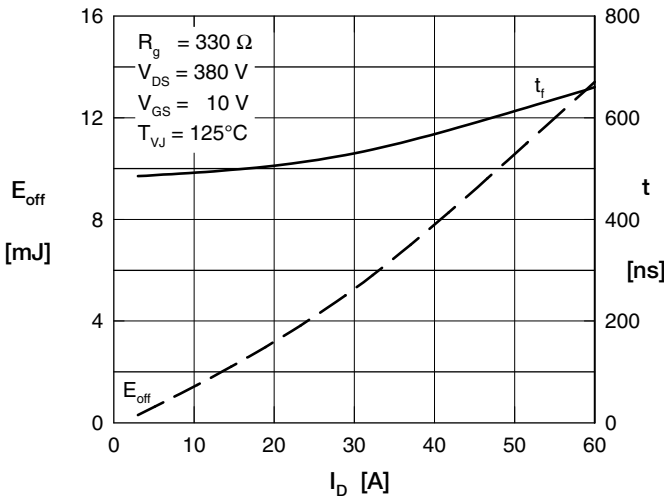

Fig. 15 Typ. turn-off energy & switching times versus collector-current, inductive switching (phaseleg)

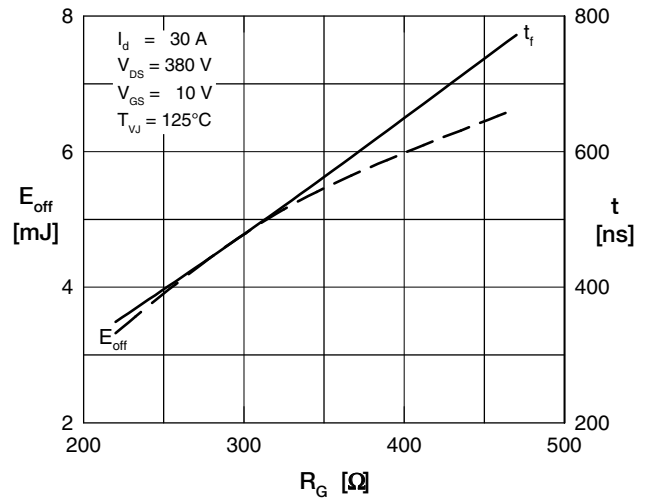

Fig. 16 Typ. turn-off energy & switching times versus gate resistor, inductive switching (phaseleg)

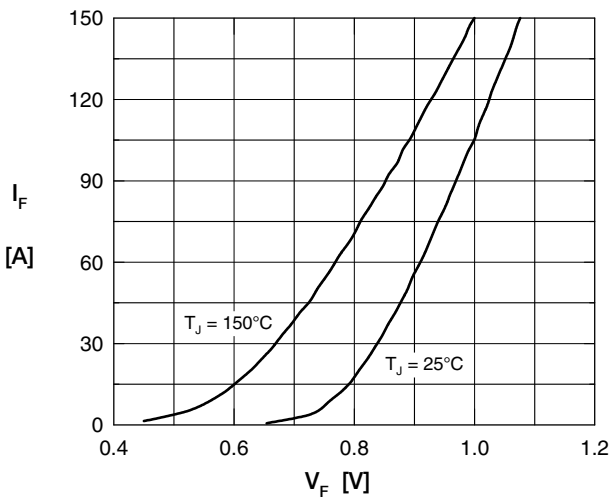

Fig. 17 Typ. forward characteristics of source drain diode D_{SD}

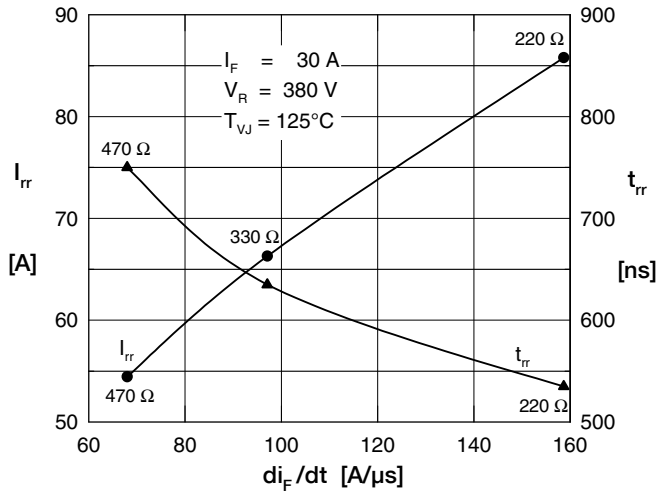

Fig. 18 Typ. reverse recovery of anti-parallel diode

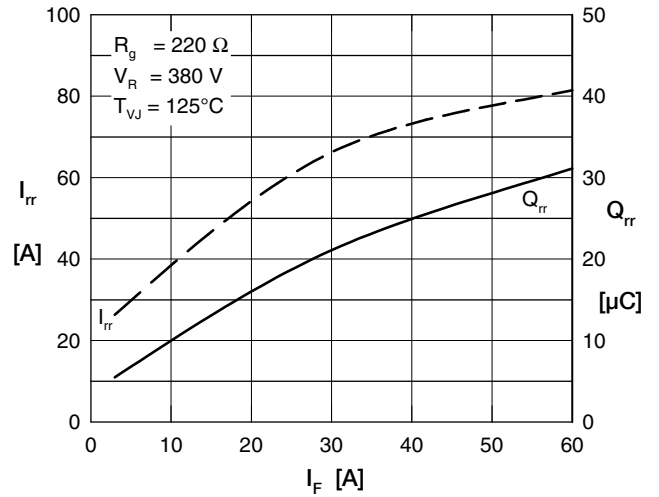

Fig. 19 Typ. reverse recovery characteristics

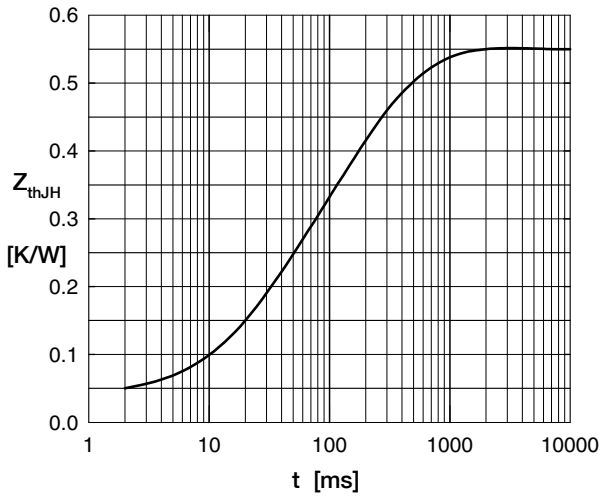

Fig. 20 Typ. transient thermal impedance of the MOSFET (IXYS test setup)