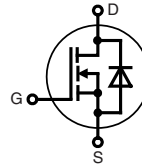
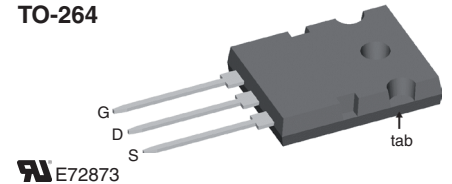

# CoolMOS™ 1) Power MOSFET

Low  $R_{DS(on)}$ , high  $V_{DSS}$   
Superjunction MOSFET

$V_{DSS} = 600\text{ V}$   
 $I_{D25} = 85\text{ A}$   
 $R_{DS(on) \text{ max}} = 36\text{ m}\Omega$

**TO-264**

MOSFET			
Symbol	Conditions	Maximum Ratings	
$V_{DSS}$	$T_{VJ} = 25^\circ\text{C}$	600	V
$V_{GS}$		$\pm 20$	V
$I_{D25}$	$T_C = 25^\circ\text{C}$	85	A
$I_{D100}$	$T_C = 100^\circ\text{C}$	55	A
$E_{AS}$	single pulse $I_D = 10\text{ A}; T_C = 25^\circ\text{C}$	1800	mJ
$E_{AR}$	repetitive $I_D = 20\text{ A}; T_C = 25^\circ\text{C}$	1	mJ
$dV/dt$	MOSFET $dV/dt$ ruggedness $V_{DS} = 0 \dots 480\text{ V}$	50	V/ns

**Features**

- 3<sup>rd</sup> generation CoolMOS™ 1) power MOSFET
- high blocking capability
- lowest resistance
- avalanche rated for unclamped inductive switching (UIS)
- low thermal resistance due to reduced chip thickness

**Applications**

- Switched mode power supplies (SMPS)
- Uninterruptible power supplies (UPS)
- Power factor correction (PFC)
- Welding
- Inductive heating

Symbol	Conditions	Characteristic Values			
		$(T_{VJ} = 25^\circ\text{C}, \text{ unless otherwise specified})$			
		min.	typ.	max.	
$R_{DS(on)}$	$V_{GS} = 10\text{ V}; I_D = I_{D100}$ ①		30	36	mΩ
$V_{GS(th)}$	$V_{DS} = V_{GS}; I_D = 5.4\text{ mA}$	2		4	V
$I_{DSS}$	$V_{DS} = V_{DSS}; V_{GS} = 0\text{ V}$			50	$\mu\text{A}$
				500	$\mu\text{A}$
$I_{GSS}$	$V_{GS} = \pm 20\text{ V}; V_{DS} = 0\text{ V}$			$\pm 200$	nA
$C_{iss}$	} $V_{GS} = 0\text{ V}; V_{DS} = 25\text{ V}$ $f = 1\text{ MHz}$		13.6		nF
$C_{oss}$			4.4		nF
$C_{rss}$			290		pF
$Q_g$	} $V_{GS} = 0\text{ to }10\text{ V}; V_{DS} = 350\text{ V}; I_D = 85\text{ A}$		500	640	nC
$Q_{gs}$			50		nC
$Q_{gd}$			240		nC
$t_{d(on)}$	} $V_{GS} = 13\text{ V}; V_{DS} = 380\text{ V}$ $I_D = 85\text{ A}; R_G = 1.0\ \Omega$		20		ns
$t_r$			27		ns
$t_{d(off)}$			110		ns
$t_f$			10		ns
$R_{thJC}$			0.18		K/W

① Pulse test,  $t \leq 300\ \mu\text{s}$ , duty cycle  $d \leq 2\%$

1) CoolMOS™ is a trademark of Infineon Technologies AG.

### Source-Drain Diode

Symbol	Conditions	Characteristic Values			
		min.	typ.	max.	
$I_S$	$V_{GS} = 0\text{ V}$			85	A
$I_{SM}$				250	A
$V_{SD}$	$I_F = 85\text{ A}; V_{GS} = 0\text{ V}$			1.2	V
$t_{rr}$	$I_F = 85\text{ A}; -di_F/dt = 200\text{ A}/\mu\text{s}; V_R = 350\text{ V}$		580		ns
$Q_{RM}$			46		$\mu\text{C}$
$I_{RM}$			140		A

( $T_{VJ} = 25^\circ\text{C}$ , unless otherwise specified)

### Component

Symbol	Conditions	Maximum Ratings		
		min.	typ.	max.
$T_{VJ}$	operating		-55...+150	$^\circ\text{C}$
$T_{stg}$			-55...+150	$^\circ\text{C}$
$M_d$	mounting torque		0.8 ... 1.2	Nm

Symbol	Conditions	Characteristic Values		
		min.	typ.	max.
$R_{thCH}$	with heatsink compound		0.15	K/W
Weight			10	g

### TO-264 Outline

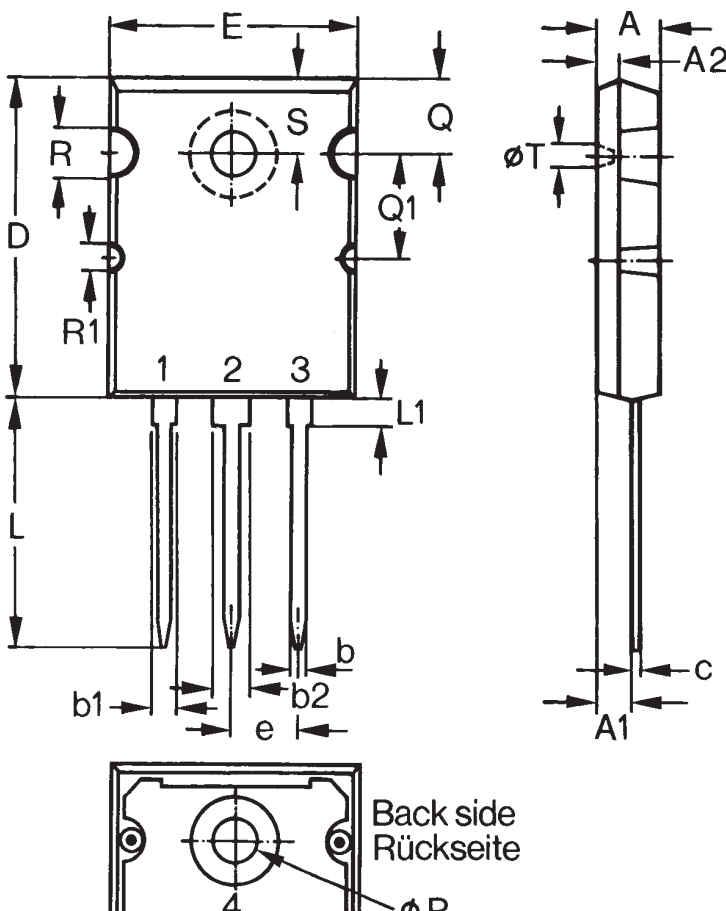

SYM	INCHES		MILLIMETERS	
	MIN	MAX	MIN	MAX
A	.185	.209	4.70	5.31
A1	.102	.118	2.59	3.00
b	.037	.055	0.94	1.40
b1	.087	.102	2.21	2.59
b2	.110	.126	2.79	3.20
C	.017	.029	0.43	0.74
D	1.007	1.047	25.58	26.59
E	.760	.799	19.30	20.29
e	.215 BSC		5.46 BSC	
L	.193	.201	4.90	5.10
L1	.088	.096	2.24	2.44
L2	.075	.083	1.90	2.10
L3	.000	.004	0.00	0.10
ØP	.122	.138	3.10	3.51
Q	.240	.256	6.10	6.50
Q1	.330	.346	8.38	8.79
ØR	.155	.187	3.94	4.75
ØR1	.085	.093	2.16	2.36
S	.243	.253	6.17	6.43

NOTE 1. This drawing meets all dimension requirement of JEDEC outline TO-264A except L, L1, L2, L3

2. All metal surface are solder patted except trimmed area

**Fig. 1. Output Characteristics @ 25 Deg. C**

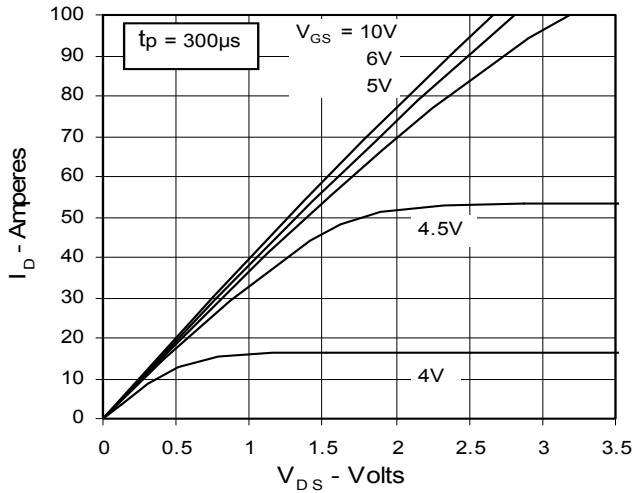

**Fig. 2. Extended Output Characteristics @ 25 deg. C**

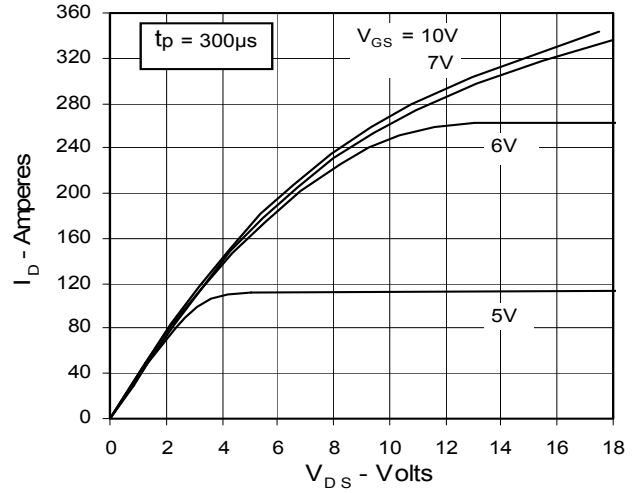

**Fig. 3. Output Characteristics @ 125 Deg. C**

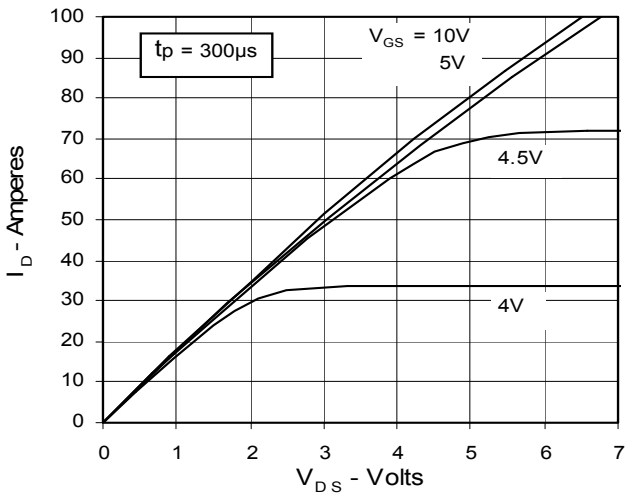

**Fig. 4. R\_DS(on) Normalized to I\_D100 Value vs. Junction Temperature**

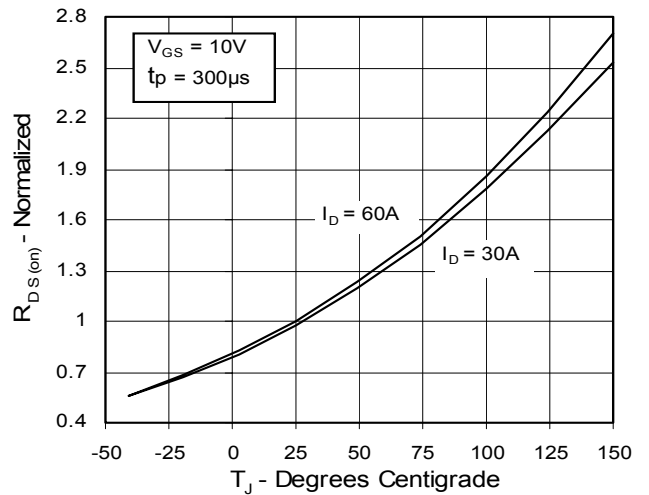

**Fig. 5. R\_DS(on) Normalized to I\_D100 Value vs. I\_D**

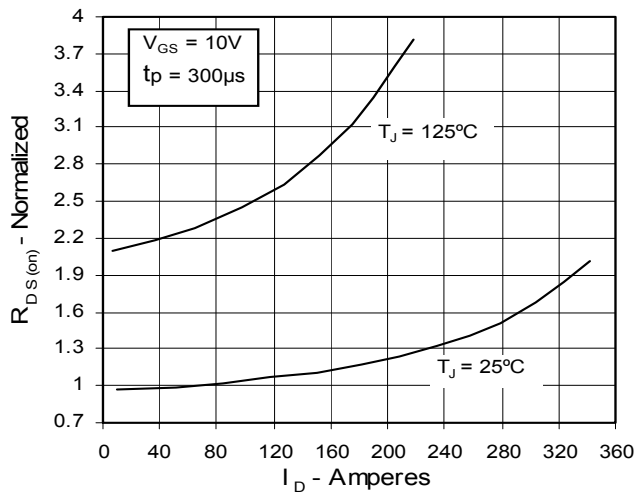

**Fig. 6. Drain Current vs. Case Temperature**

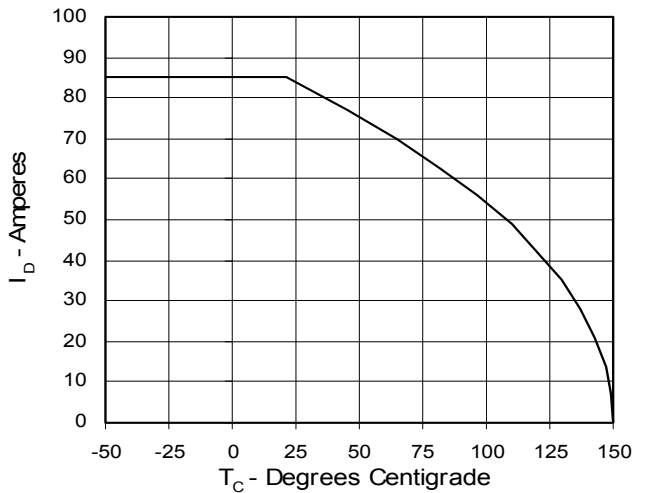

**Fig. 7. Input Admittance**

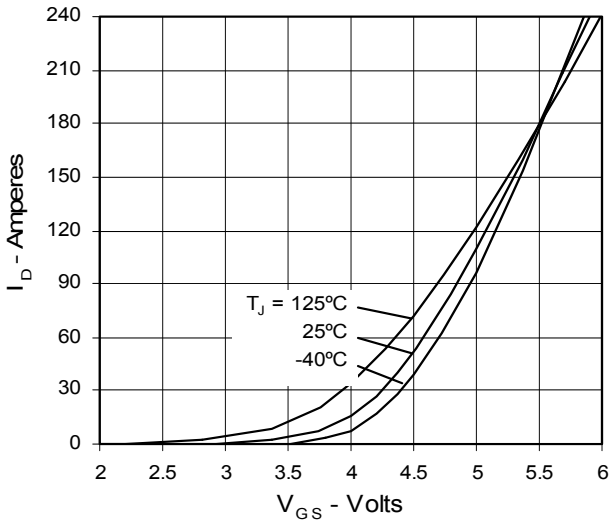

**Fig. 8. Transconductance**

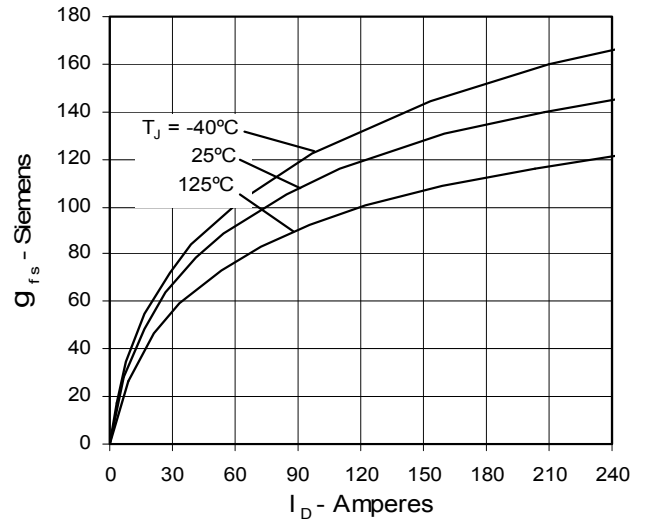

**Fig. 9. Source Current vs. Source-To-Drain Voltage**

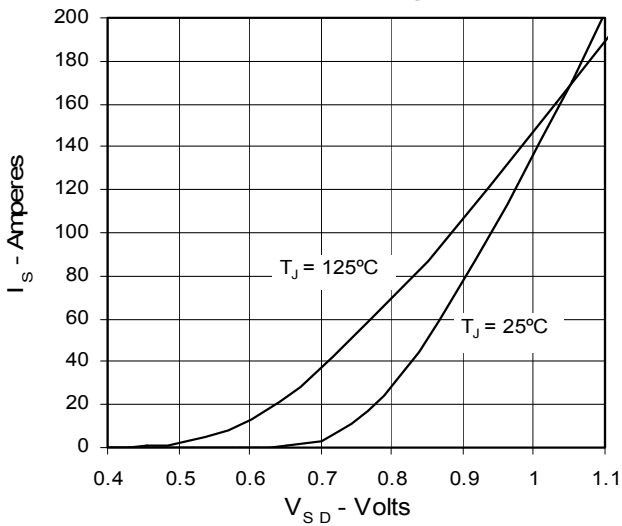

**Fig. 10. Gate Charge**

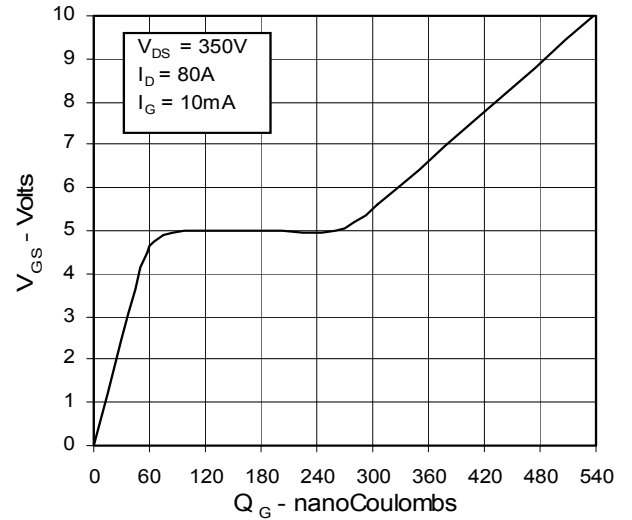

**Fig. 11. Capacitance**

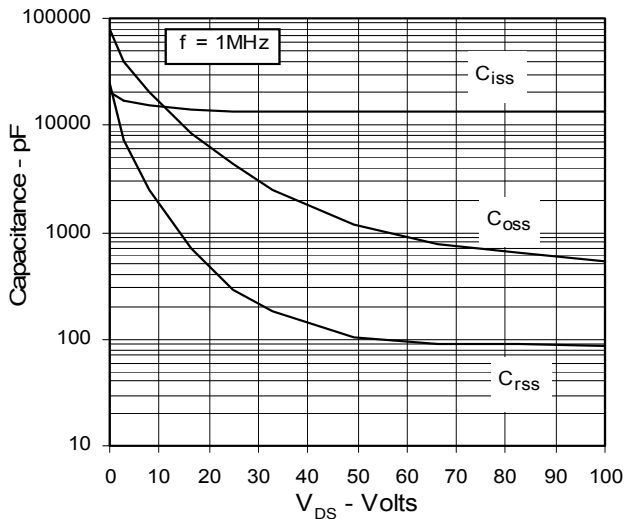

**Fig. 12. Maximum Transient Thermal Resistance**

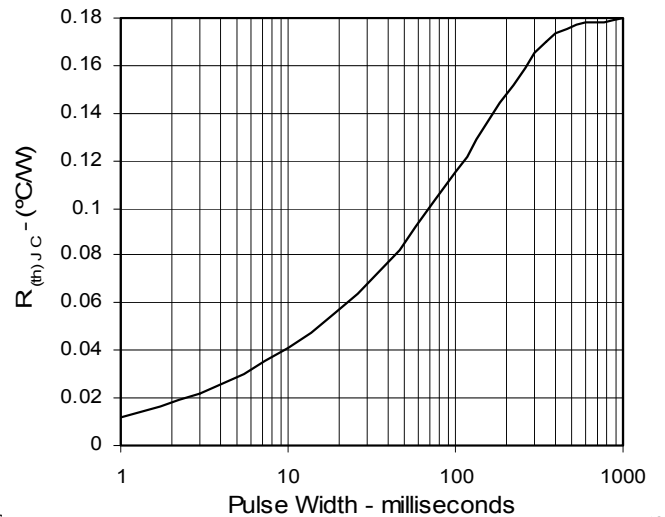



---

Disclaimer Notice - Information furnished is believed to be accurate and reliable. However, users should independently evaluate the suitability of and test each product selected for their own applications. Littelfuse products are not designed for, and may not be used in, all applications. Read complete Disclaimer Notice at [www.littelfuse.com/disclaimer-electronics](http://www.littelfuse.com/disclaimer-electronics).