

Q3-Class HiperFET™ Power MOSFET

(Electrically Isolated Tab)

IXFR24N100Q3

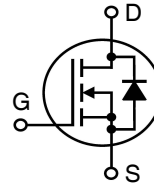

$V_{DSS} = 1000V$
 $I_{D25} = 18A$
 $R_{DS(on)} \leq 490m\Omega$
 $t_{rr} \leq 300ns$

N-Channel Enhancement Mode
Fast Intrinsic Rectifier

ISOPLUS247
E153432

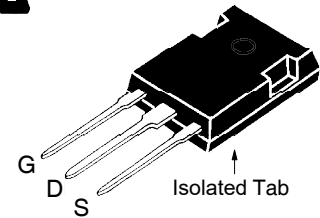

G = Gate D = Drain
S = Source

Symbol	Test Conditions	Maximum Ratings	
V_{DSS}	$T_J = 25^\circ C$ to $150^\circ C$	1000	V
V_{DGR}	$T_J = 25^\circ C$ to $150^\circ C$, $R_{GS} = 1M\Omega$	1000	V
V_{GSS}	Continuous	± 30	V
V_{GSM}	Transient	± 40	V
I_{D25}	$T_C = 25^\circ C$	18	A
I_{DM}	$T_C = 25^\circ C$, Pulse Width Limited by T_{JM}	60	A
I_A	$T_C = 25^\circ C$	24	A
E_{AS}	$T_C = 25^\circ C$	2	J
dv/dt	$I_S \leq I_{DM}$, $V_{DD} \leq V_{DSS}$, $T_J \leq 150^\circ C$	50	V/ns
P_D	$T_C = 25^\circ C$	500	W
T_J		-55 ... +150	$^\circ C$
T_{JM}		150	$^\circ C$
T_{stg}		-55 ... +150	$^\circ C$
T_L	Maximum Lead Temperature for Soldering	300	$^\circ C$
T_{SOLD}	Plastic Body for 10s	260	$^\circ C$
V_{ISOL}	50/60 Hz, 1 Minute	2500	V~
F_C	Mounting Force	20..120/4.5..27	N/lb.
Weight		5	g

Features

- Silicon Chip on Direct-Copper Bond (DCB) Substrate
- Isolated Mounting Surface
- Low Intrinsic Gate Resistance
- 2500V~ Electrical Isolation
- Fast Intrinsic Rectifier
- Avalanche Rated
- Low Package Inductance

Advantages

- High Power Density
- Easy to Mount
- Space Savings

Applications

- DC-DC Converters
- Battery Chargers
- Switch-Mode and Resonant-Mode Power Supplies
- DC Choppers
- Temperature and Lighting Controls

Symbol	Test Conditions ($T_J = 25^\circ C$ Unless Otherwise Specified)	Characteristic Values		
		Min.	Typ.	Max.
BV_{DSS}	$V_{GS} = 0V$, $I_D = 1mA$	1000		V
$V_{GS(th)}$	$V_{DS} = V_{GS}$, $I_D = 4mA$	3.5		6.5 V
I_{GSS}	$V_{GS} = \pm 30V$, $V_{DS} = 0V$			± 200 nA
I_{DSS}	$V_{DS} = V_{DSS}$, $V_{GS} = 0V$ $T_J = 125^\circ C$			25 μA 1.5 mA
$R_{DS(on)}$	$V_{GS} = 10V$, $I_D = 12A$, Note 1			490 m Ω

Symbol	Test Conditions ($T_J = 25^\circ\text{C}$ Unless Otherwise Specified)	Characteristic Values		
		Min.	Typ.	Max.
g_{fs}	$V_{DS} = 20\text{V}, I_D = 12\text{A}$, Note 1	14	24	S
C_{iss}	$V_{GS} = 0\text{V}, V_{DS} = 25\text{V}, f = 1\text{MHz}$		7200	pF
C_{oss}			590	pF
C_{rss}			50	pF
R_{Gi}	Gate Input Resistance		0.18	Ω
$t_{d(on)}$	Resistive Switching Times $V_{GS} = 10\text{V}, V_{DS} = 0.5 \cdot V_{DSS}, I_D = 12\text{A}$ $R_G = 1\Omega$ (External)		38	ns
t_r			24	ns
$t_{d(off)}$			45	ns
t_f			14	ns
$Q_{g(on)}$	$V_{GS} = 10\text{V}, V_{DS} = 0.5 \cdot V_{DSS}, I_D = 12\text{A}$		140	nC
Q_{gs}			47	nC
Q_{gd}			60	nC
R_{thJC}				0.25 $^\circ\text{C/W}$
R_{thCS}		0.15		$^\circ\text{C/W}$

Source-Drain Diode

Symbol	Test Conditions ($T_J = 25^\circ\text{C}$ Unless Otherwise Specified)	Characteristic Values		
		Min.	Typ.	Max.
I_S	$V_{GS} = 0\text{V}$			24 A
I_{SM}	Repetitive, Pulse Width Limited by T_{JM}			96 A
V_{SD}	$I_F = I_S, V_{GS} = 0\text{V}$, Note 1			1.4 V
t_{rr}	$I_F = 12\text{A}, -di/dt = 100\text{A}/\mu\text{s}$ $V_R = 100\text{V}, V_{GS} = 0\text{V}$			300 ns
Q_{RM}			1.9	μC
I_{RM}			12.4	A

Note 1. Pulse test, $t \leq 300\mu\text{s}$, duty cycle, $d \leq 2\%$.

IXYS Reserves the Right to Change Limits, Test Conditions, and Dimensions.

IXYS MOSFETs and IGBTs are covered by one or more of the following U.S. patents:	4,835,592	4,931,844	5,049,961	5,237,481	6,162,665	6,404,065 B1	6,683,344	6,727,585	7,005,734 B2	7,157,338B2
	4,860,072	5,017,508	5,063,307	5,381,025	6,259,123 B1	6,534,343	6,710,405 B2	6,759,692	7,063,975 B2	
	4,881,106	5,034,796	5,187,117	5,486,715	6,306,728 B1	6,583,505	6,710,463	6,771,478 B2	7,071,537	

Fig. 1. Output Characteristics @ $T_J = 25^\circ\text{C}$

Fig. 2. Extended Output Characteristics @ $T_J = 25^\circ\text{C}$

Fig. 3. Output Characteristics @ $T_J = 125^\circ\text{C}$

Fig. 4. $R_{DS(on)}$ Normalized to $I_D = 12\text{A}$ Value vs. Junction Temperature

Fig. 5. $R_{DS(on)}$ Normalized to $I_D = 12\text{A}$ Value vs. Drain Current

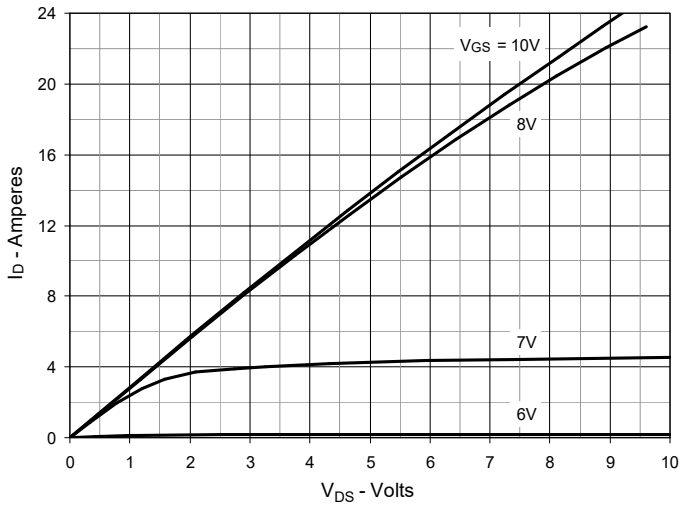
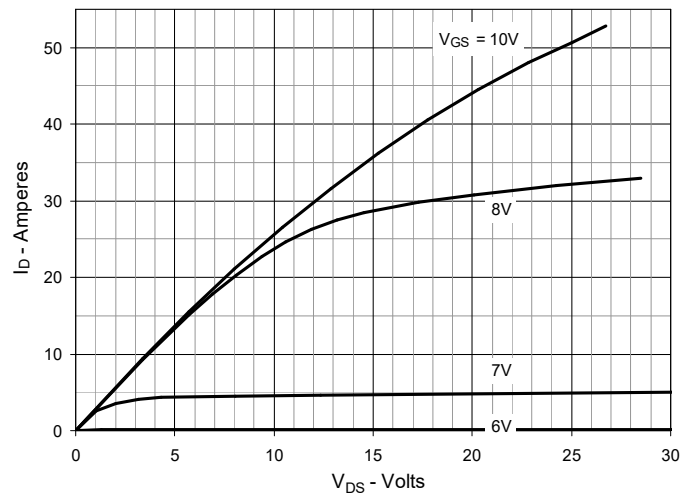
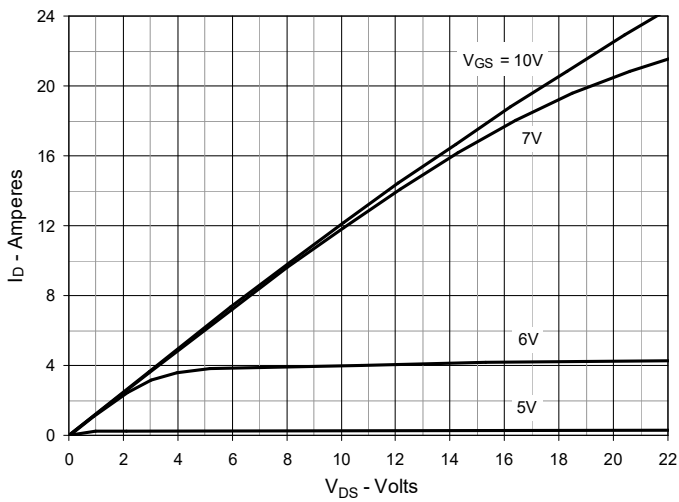
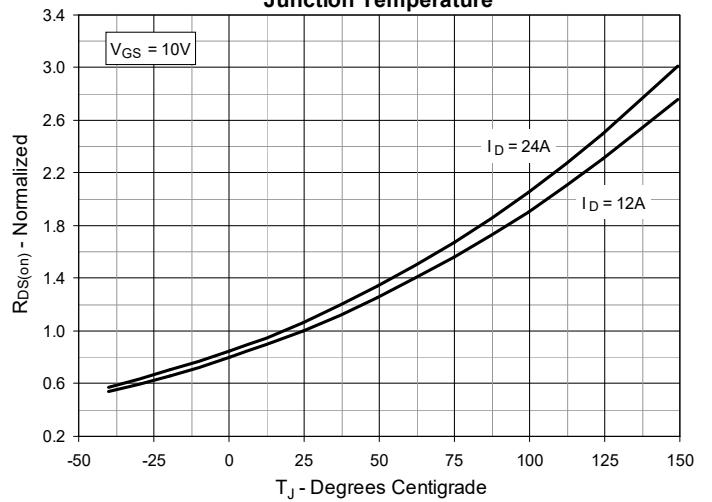
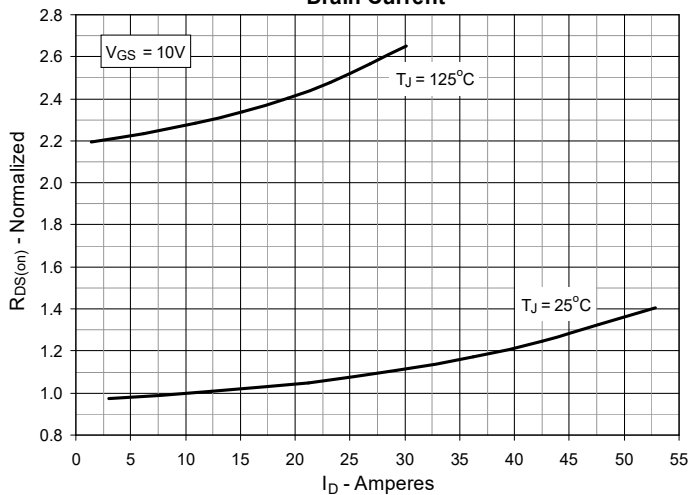
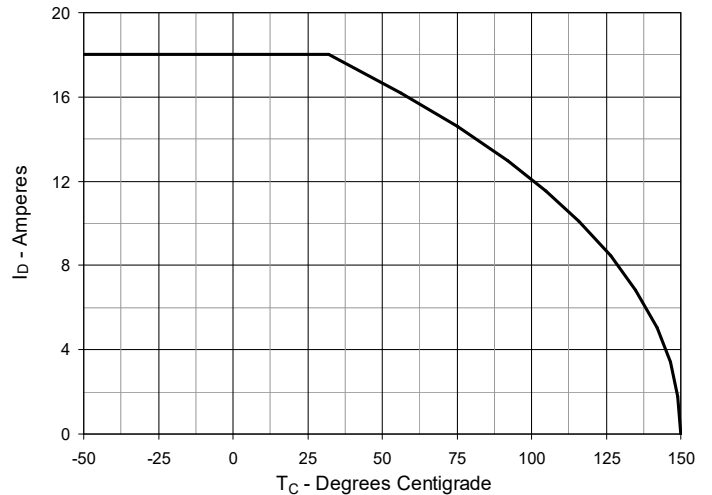
Fig. 6. Maximum Drain Current vs. Case Temperature

Fig. 7. Input Admittance

Fig. 8. Transconductance

Fig. 9. Forward Voltage Drop of Intrinsic Diode

Fig. 10. Gate Charge

Fig. 11. Capacitance

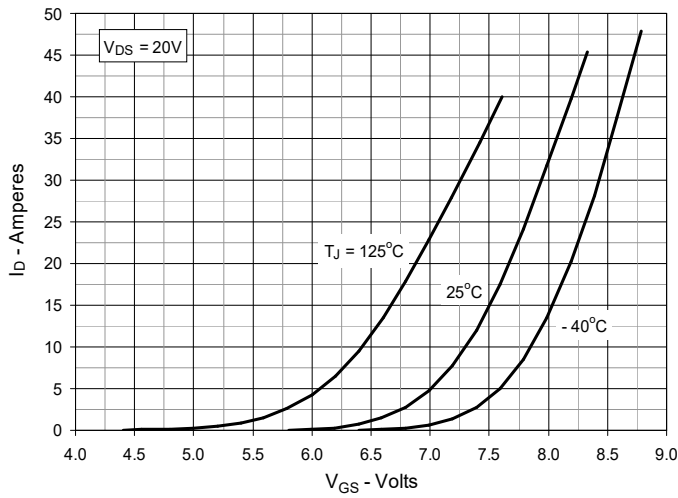
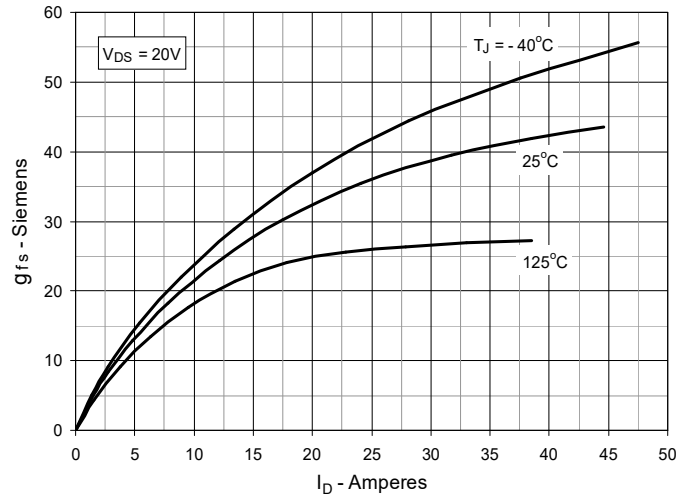
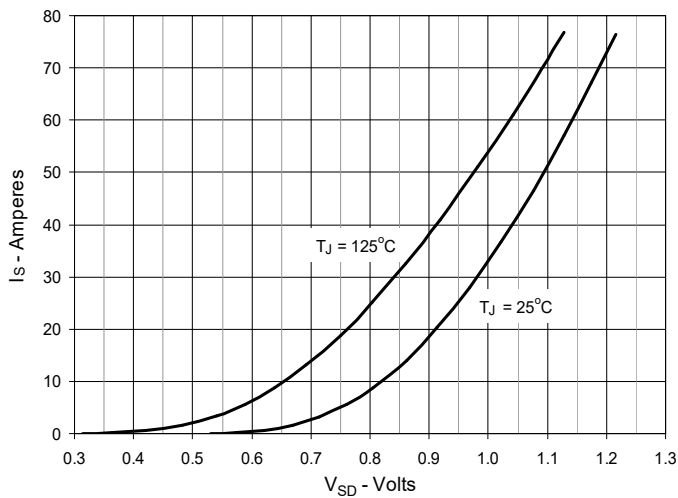
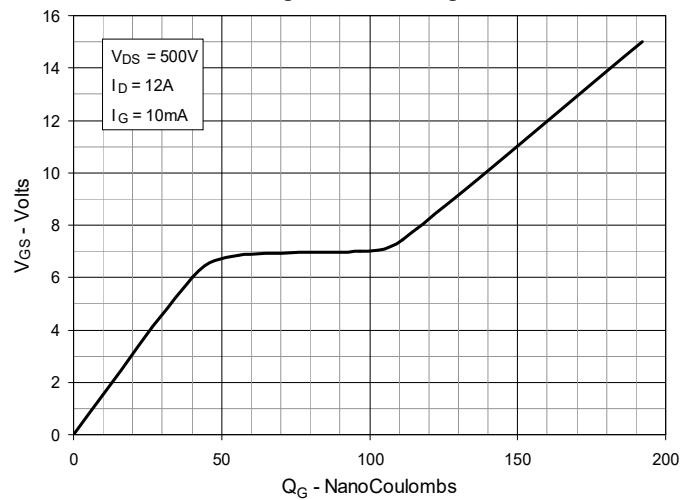
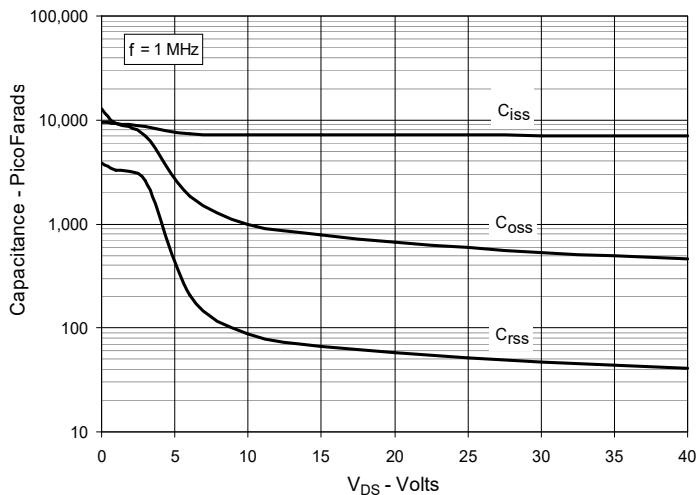
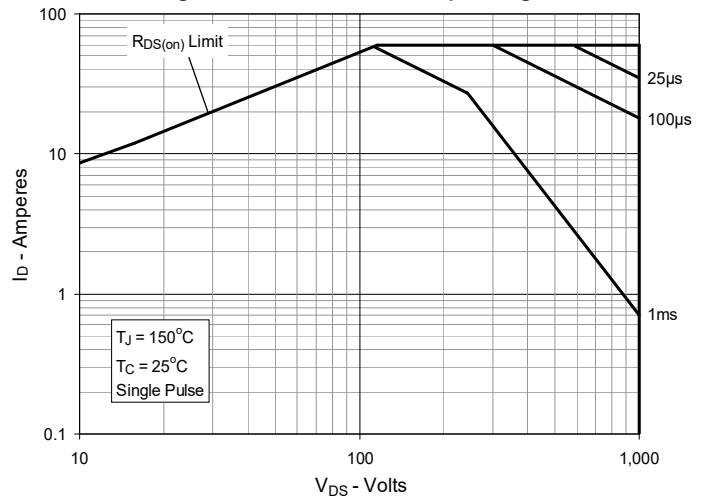
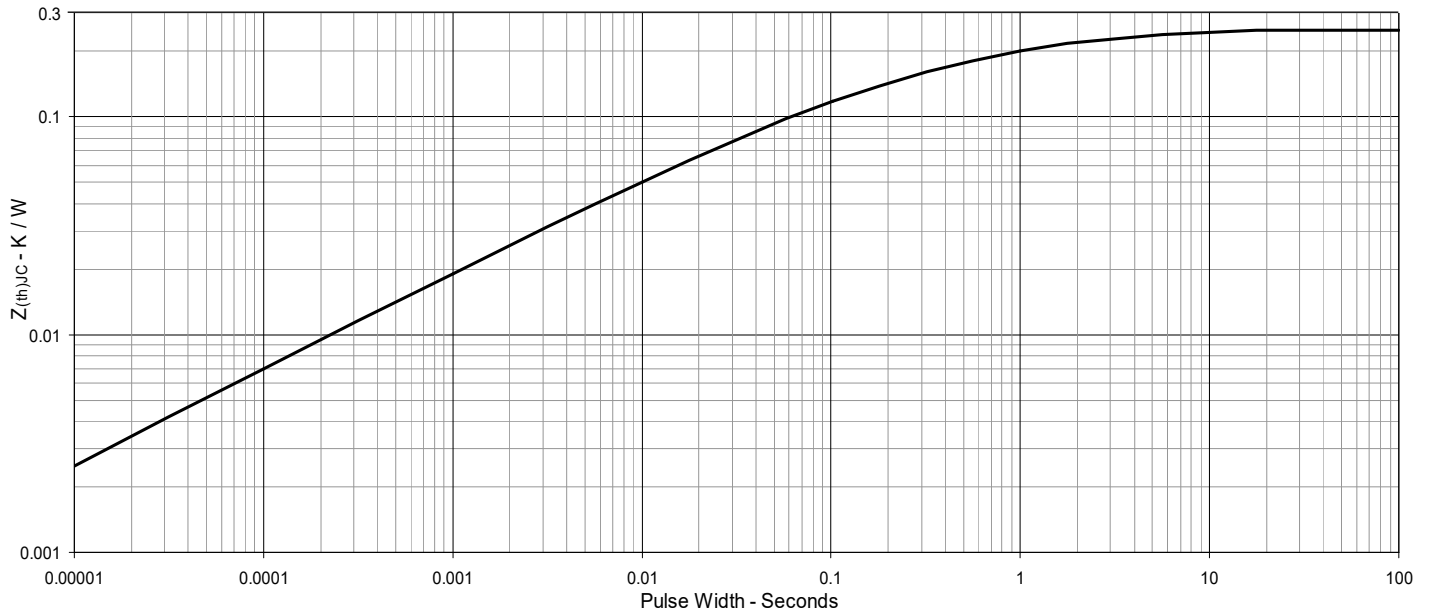
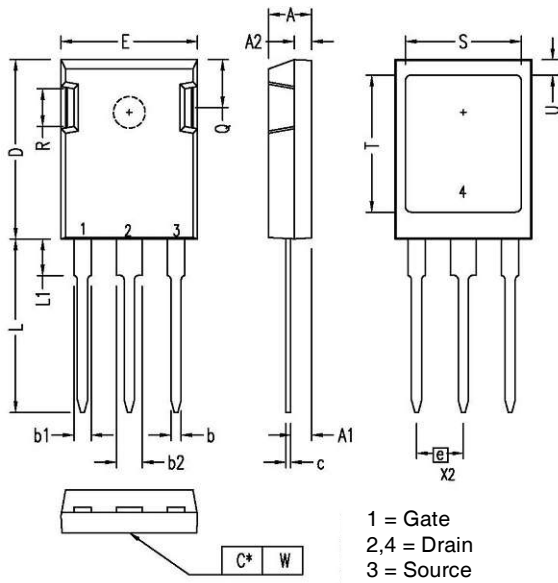
Fig. 12. Forward-Bias Safe Operating Area

Fig. 13. Maximum Transient Thermal Impedance



ISOPLUS247 (IXFR) Outline

SYM	INCHES		MILLIMETERS	
	MIN	MAX	MIN	MAX
A	.190	.205	4.83	5.21
A1	.090	.100	2.29	2.54
A2	.075	.085	1.91	2.16
b	.045	.055	1.14	1.40
b1	.075	.085	1.91	2.15
b2	.115	.126	2.92	3.20
C	.024	.033	0.61	0.83
D	.819	.840	20.80	21.34
E	.620	.635	15.75	16.13
e	.215 BSC		5.45 BSC	
L	.780	.811	19.81	20.60
L1	.150	.172	3.81	4.38
Q	.220	.244	5.59	6.20
R	.170	.191	4.32	4.85
S	.520	.540	13.21	13.72
T	.620	.640	15.75	16.26
U	.065	.080	1.65	2.03
W	0	.004	0	0.10



Disclaimer Notice - Information furnished is believed to be accurate and reliable. However, users should independently evaluate the suitability of and test each product selected for their own applications. Littelfuse products are not designed for, and may not be used in, all applications. Read complete Disclaimer Notice at www.littelfuse.com/disclaimer-electronics.
