

IXTY2P50PA

–500 V, –2 A PolarP™ MOSFET

P-Channel Enhancement Mode

**Features & Benefits:**

- AEC Q101 Qualified
- Avalanche Rated
- Rugged PolarP™ Process
- Low Package Inductance
- Easy to Mount
- Space Savings

Applications:

- High-side Switches
- Push Pull Amplifiers
- DC Choppers
- Automatic Test Equipment
- Current Regulators

Product Summary

Characteristics	Value	Unit
V_{DSS}	–500	V
$R_{DS(on),max}$	4.2	Ω
I_{D25}	–2	A

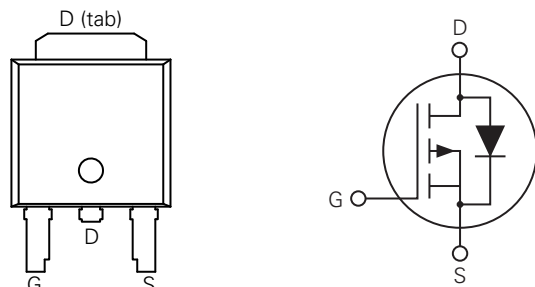
Pinout Diagram (TO-252)**G:** Gate; **D:** Drain; **S:** Source; **tab:** Drain

Maximum Ratings

Symbol	Characteristics	Conditions	Value	Units
V_{DSS}	Drain-Source Voltage	$T_J = 25\text{ }^\circ\text{C}$ to $150\text{ }^\circ\text{C}$	-500	V
V_{GSS}	Gate-Source Voltage	Continuous	± 20	V
V_{GSM}		Transient	± 30	
I_{D25}	Drain Current	$T_C = 25\text{ }^\circ\text{C}$	-2	A
I_{DM}		$T_C = 25\text{ }^\circ\text{C}$, Pulse width limited by T_{JM}	-6	
I_A	Avalanche Current	$T_C = 25\text{ }^\circ\text{C}$	-2	A
E_{AS}	Avalanche Energy	$T_C = 25\text{ }^\circ\text{C}$	150	mJ
dV/dt	Reverse Diode dV/dt	$I_S \leq I_{DM}$, $V_{DD} \leq V_{DSS}$, $T_J \leq 150\text{ }^\circ\text{C}$	10	V/ns
P_D	Power Dissipation	$T_C = 25\text{ }^\circ\text{C}$	58	W
T_J	Operating Junction Temperature	-	-55 to +150	$^\circ\text{C}$
T_{JM}	Maximum Junction Temperature	-	150	
T_{stg}	Storage Temperature	-	-55 to +150	
T_{sold}	Soldering Temperature	Plastic Body for 10 s	260	
W	Weight	-	0.35	g

Thermal Characteristics

Symbol	Characteristic	Value			Unit
		Min.	Typ.	Max.	
$R_{th, JC}$	Thermal Resistance, Junction-to-Case	-	-	2.15	$^\circ\text{C}/\text{W}$

Electrical Characteristics – Static ($T_J = 25\text{ }^\circ\text{C}$ unless otherwise specified)

Symbol	Characteristic	Conditions	Value			Unit
			Min.	Typ.	Max.	
BV_{DSS}	Drain-Source Breakdown Voltage	$I_D = -250\text{ }\mu\text{A}$, $V_{GS} = 0\text{ V}$	-500	-	-	V
$V_{GS(th)}$	Gate Threshold Voltage	$I_D = -50\text{ }\mu\text{A}$, $V_{GS} = V_{DS}$	-2.5	-	-4.5	V
I_{GSS}	Gate-Source Leakage Current	$V_{DS} = 0\text{ V}$, $V_{GS} = \pm 20\text{ V}$	-	-	± 50	nA
I_{DSS}	Drain-Source Current	$V_{DS} = V_{DSS}$, $V_{GS} = 0\text{ V}$	-	-	-1	μA
		$V_{DS} = V_{DSS}$, $V_{GS} = 0\text{ V}$, $T_J = 125\text{ }^\circ\text{C}$	-	-	-5	
$R_{DS(on)}$	Drain-Source On-Resistance ¹	$V_{GS} = -10\text{ V}$, $I_D = 0.5 \times I_{D25}$	-	-	4.2	Ω

Note 1: Pulse test, $t \leq 300\text{ }\mu\text{s}$, duty cycle, $d \leq 2\%$

Electrical Characteristics – Dynamic ($T_J = 25\text{ }^\circ\text{C}$ unless otherwise specified)

Symbol	Characteristic	Conditions	Value			Unit
			Min.	Typ.	Max.	
g_{fs}	Transconductance ¹	$V_{DS} = -10\text{ V}, I_D = 0.5 \times I_{D25}$	1.4	2.4	–	S
C_{iss}	Input Capacitance	$V_{GS} = 0\text{ V}, V_{DS} = -25\text{ V}, f = 1\text{ MHz}$	–	600	–	pF
C_{oss}	Output Capacitance		–	70	–	
C_{rss}	Reverse Transfer Capacitance		–	12	–	
$Q_{g(on)}$	Total Gate Charge	$V_{GS} = -10\text{ V}, V_{DS} = 0.5 \times V_{DSS},$ $I_D = 0.5 \times I_{D25}$	–	11.9	–	nC
Q_{gs}	Gate-Source Charge		–	4.0	–	
Q_{gd}	Gate-Drain Charge		–	4.3	–	
$t_{d(on)}$	Turn-on Delay Time	Resistive Switching $V_{GS} = -10\text{ V}, V_{DS} = 0.5 \times V_{DSS},$ $I_D = 0.5 \times I_{D25}, R_{G(ext)} = 50\ \Omega$	–	26	–	ns
t_r	Rise Time		–	62	–	
$t_{d(off)}$	Turn-off Delay Time		–	54	–	
t_f	Fall Time		–	66	–	

Note 1: Pulse test, $t \leq 300\ \mu\text{s}$, duty cycle, $d \leq 2\%$

Source-Drain Diode Characteristics ($T_J = 25\text{ }^\circ\text{C}$ unless otherwise specified)

Symbol	Characteristic	Conditions	Value			Unit
			Min.	Typ.	Max.	
I_S	Continuous Diode Forward Current	$V_{GS} = 0\text{ V}$	–	–	-2	A
I_{SM}	Diode Pulse Current	Repetitive, Pulse width limited by T_{JM}	–	–	-8	A
V_{SD}	Diode Forward Voltage ¹	$I_F = -2\text{ A}, V_{GS} = 0\text{ V}$	–	–	-2.8	V
t_{rr}	Reverse Recovery Time	$I_F = -1\text{ A}, -di/dt = -100\text{ A}/\mu\text{s},$ $V_r = -100\text{ V}, V_{GS} = 0\text{ V}$	–	300	–	ns
Q_{rm}	Reverse Recovery Charge		–	3.9	–	μC
I_{rm}	Reverse Recovery Current		–	-26	–	A

Note 1: Pulse test, $t \leq 300\ \mu\text{s}$, duty cycle, $d \leq 2\%$

Characteristic Curves

Fig. 1. Output Characteristics @ $T_J = 25\text{ }^\circ\text{C}$

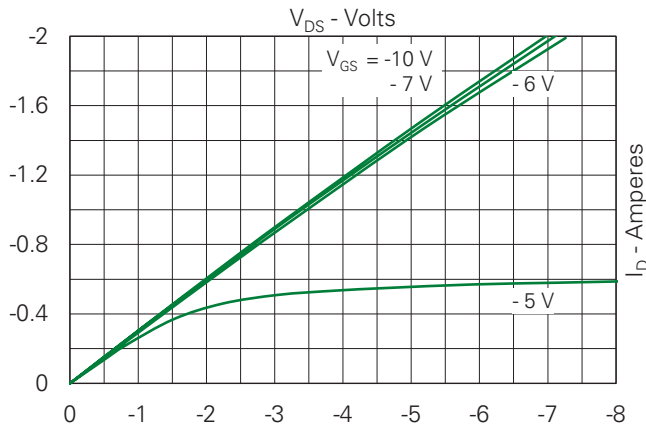

Fig. 2. Extended Output Characteristics @ $T_J = 25\text{ }^\circ\text{C}$

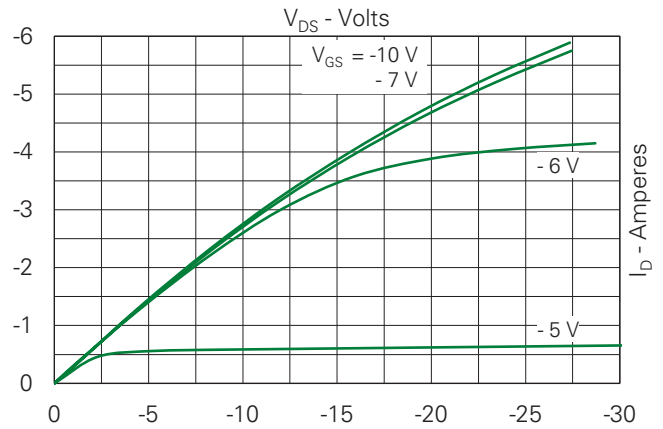

Fig. 3. Output Characteristics @ $T_J = 125\text{ }^\circ\text{C}$

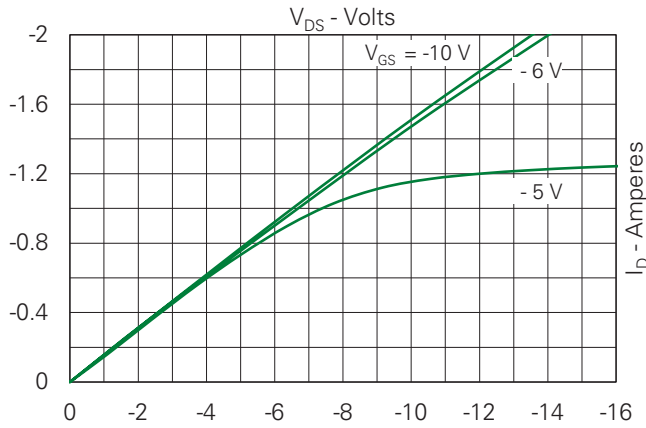

Fig. 4. $R_{DS(on)}$ Normalized to $I_D = -1\text{ A}$ Value vs. Junction Temperature

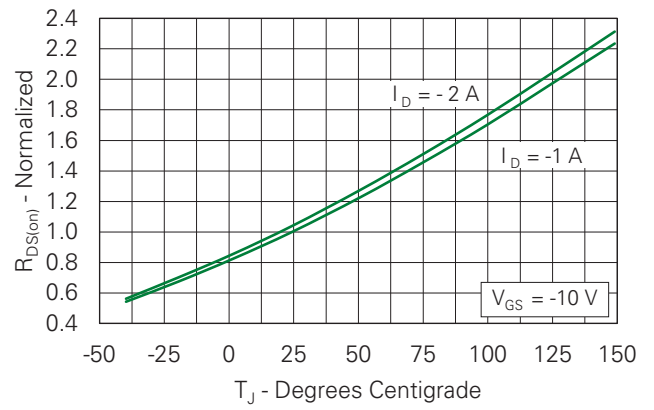

Fig. 5. $R_{DS(on)}$ Normalized to $I_D = -1\text{ A}$ Value vs. Drain Current

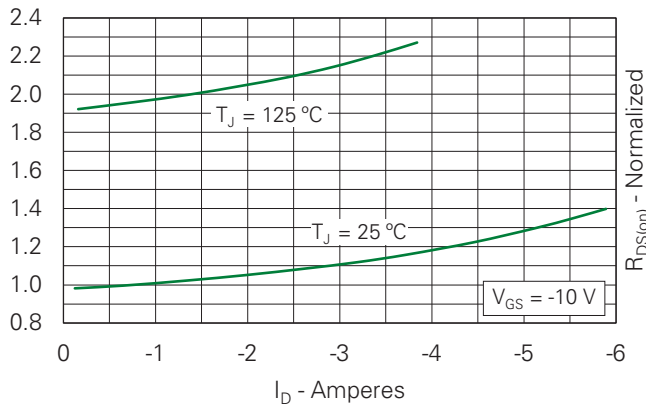

Fig. 6. Maximum Drain Current vs. Case Temperature

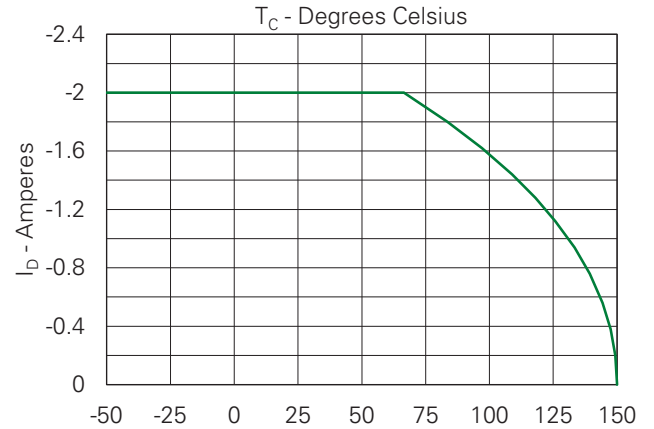

Fig. 7. Input Admittance

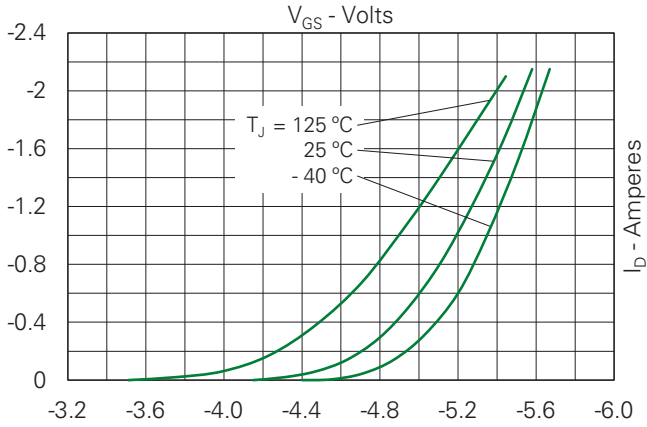

Fig. 8. Transconductance

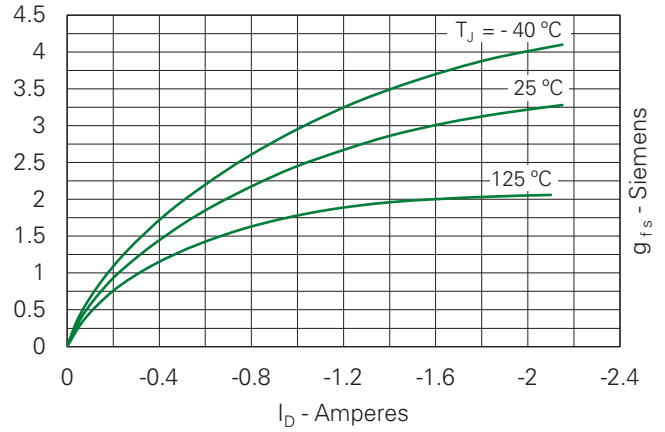

Fig. 9. Forward Voltage Drop of Intrinsic Diode

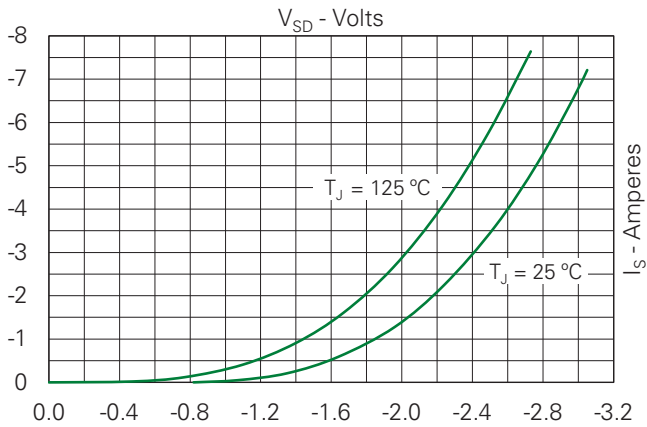

Fig. 10. Gate Charge

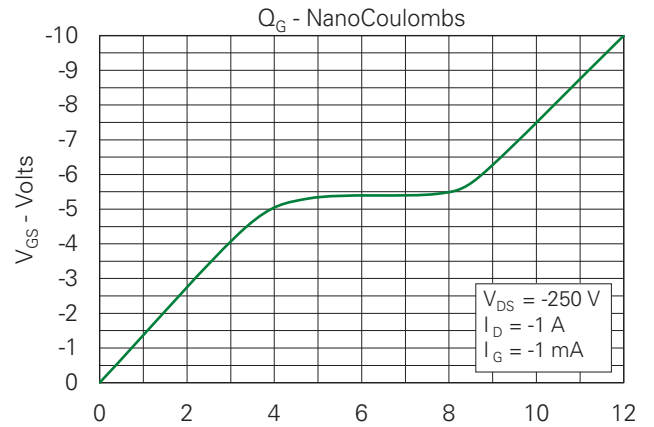

Fig. 11. Capacitance

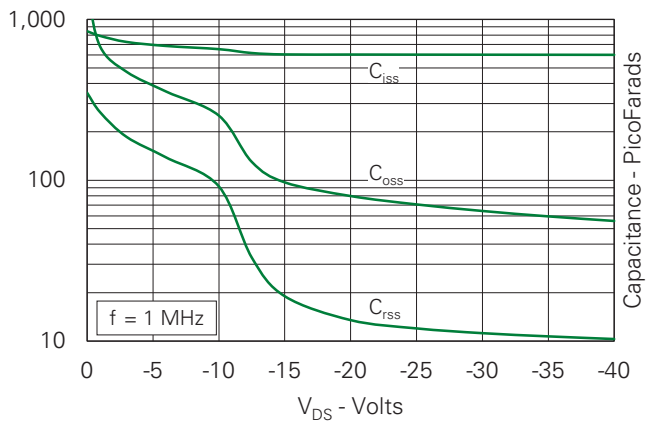

Fig. 12. Forward-Bias Safe Operating Area

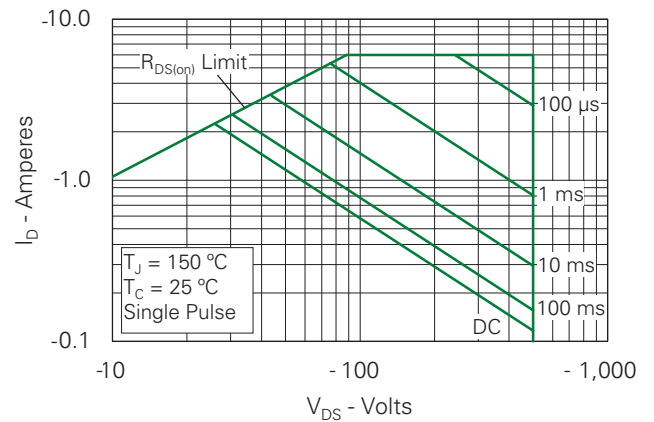
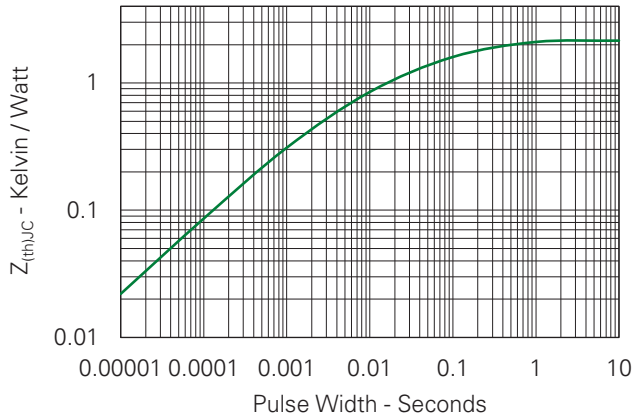
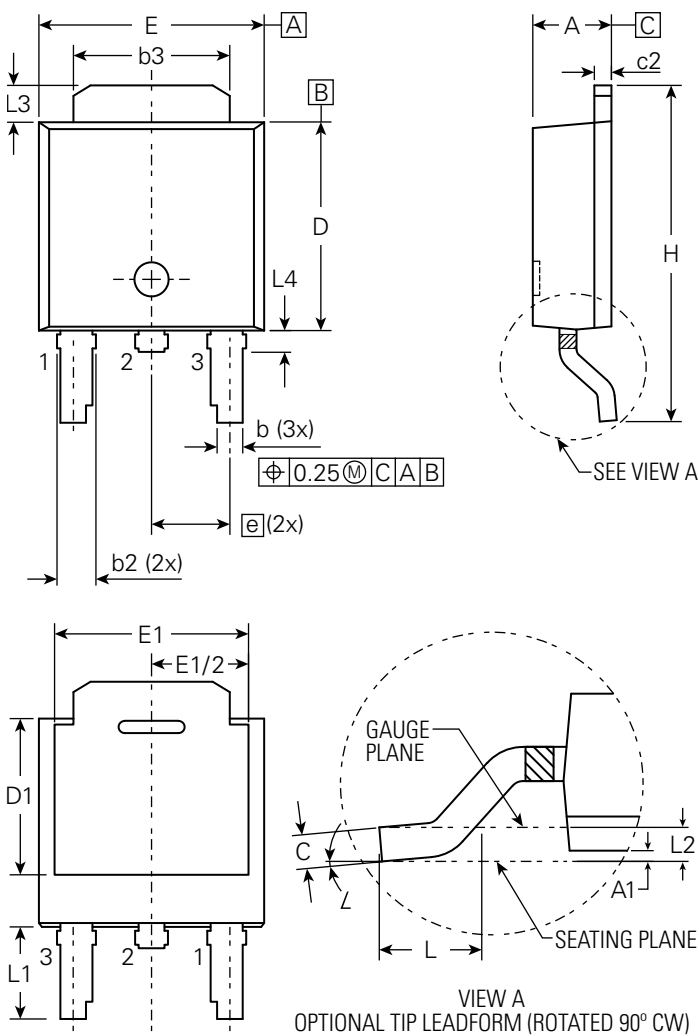

Fig. 13. Maximum Transient Thermal Impedance



Part Outline Drawing (TO-252)



Symbol	Inches			Millimeters		
	Min.	Typical	Max.	Min.	Typical	Max.
A	0.086	0.090	0.094	2.18	2.28	2.38
A1	-	-	0.005	-	-	0.13
b	0.025	0.030	0.035	0.63	0.76	0.89
b2	0.028	0.037	0.045	0.72	0.93	1.14
b3	0.180	0.198	0.215	4.57	5.02	5.46
c	0.018	0.021	0.024	0.46	0.54	0.61
c2	0.018	0.021	0.024	0.46	0.54	0.61
D	0.235	0.240	0.245	5.97	6.10	6.22
D1	0.215	0.222	0.230	5.45	5.65	5.85
E	0.250	0.257	0.265	6.35	6.54	6.73
E1	0.202	0.210	0.218	5.14	5.34	5.54
e	-	0.090	-	-	2.29	-
H	0.370	0.390	0.410	9.40	9.91	10.41
L	0.055	0.063	0.070	1.40	1.59	1.78
L1	-	0.114	-	-	2.90	-
L2	-	0.020	-	-	0.51	-
L3	0.035	0.043	0.050	0.89	1.08	1.27
L4	-	0.020	0.040	-	0.51	1.01
L	-	-	10 deg.	-	-	10 deg.

Disclaimer Notice - Information furnished is believed to be accurate and reliable. However, users should independently evaluate the suitability of and test each product selected for their own applications. Littelfuse products are not designed for, and may not be used in, all applications. Read complete Disclaimer Notice at <http://www.littelfuse.com/disclaimer-electronics>.